

# BACA-AMP-76 ✓ ACTIVE

MATE-N-LOK | Mini-Universal MATE-N-LOK

TE Internal #: 794758-1

Single Wire Seal, Silicone Rubber, Blue, .04 – .083 in [1.02 – 2.11 mm] Insulation Diameter, Mini-Universal MATE-N-LOK

[View on TE.com >](#)



Connectors > Connector Accessories > Connector Seals & Cavity Plugs

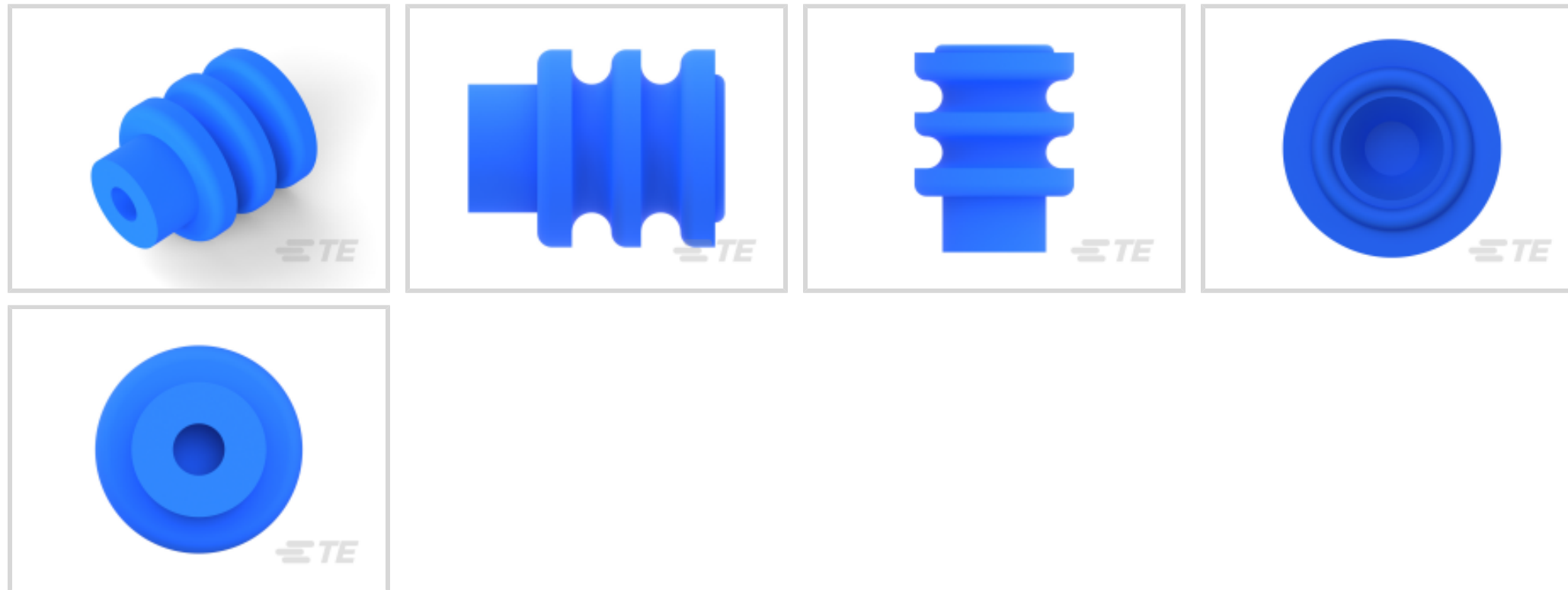

Connector Seal & Plug Type: **Single Wire Seal**

Primary Product Material: **Silicone Rubber**

Primary Product Color: **Blue**

Compatible Insulation Diameter Range: **1.02 – 2.11 mm [ .04 – .083 in ]**

Operating Temperature (Max): **90 °C [ 194 °F ]**

## Features

### Product Type Features

Connector Seal & Plug Type	Single Wire Seal
----------------------------	------------------

### Body Features

Primary Product Material	Silicone Rubber
Primary Product Color	Blue

### Dimensions

Wire Size	.12 – .9 mm <sup>2</sup>
Compatible Insulation Diameter Range	1.02 – 2.11 mm [.04 – .083 in]

### Usage Conditions

Operating Temperature (Max)	90 °C [194 °F]
Operating Temperature Range	-40 – 90 °C [-40 – 194 °F]

### Packaging Features

Packaging Quantity	20000
Packaging Method	Bag/Box



## Product Compliance

[For compliance documentation, visit the product page on TE.com>](#)

EU RoHS Directive 2011/65/EU	Compliant
EU ELV Directive 2000/53/EC	Compliant
China RoHS 2 Directive MIIT Order No 32, 2016	No Restricted Materials Above Threshold
EU REACH Regulation (EC) No. 1907/2006	Current ECHA Candidate List: JUNE 2023 (235) Candidate List Declared Against: JUNE 2023 (235) Does not contain REACH SVHC
Halogen Content	Low Halogen - Br, Cl, F, I < 900 ppm per homogenous material. Also BFR/CFR/PVC Free
Solder Process Capability	Not applicable for solder process capability

### Product Compliance Disclaimer

This information is provided based on reasonable inquiry of our suppliers and represents our current actual knowledge based on the information they provided. This information is subject to change. The part numbers that TE has identified as EU RoHS compliant have a maximum concentration of 0.1% by weight in homogenous materials for lead, hexavalent chromium, mercury, PBB, PBDE, DBP, BBP, DEHP, DIBP, and 0.01% for cadmium, or qualify for an exemption to these limits as defined in the Annexes of Directive 2011/65/EU (RoHS2). Finished electrical and electronic equipment products will be CE marked as required by Directive 2011/65/EU. Components may not be CE marked. Additionally, the part numbers that TE has identified as EU ELV compliant have a maximum concentration of 0.1% by weight in homogenous materials for lead, hexavalent chromium, and mercury, and 0.01% for cadmium, or qualify for an exemption to these limits as defined in the Annexes of Directive 2000/53/EC (ELV). Regarding the REACH Regulation, the information TE provides on SVHC in articles for this part number is based on the latest European Chemicals Agency (ECHA) 'Guidance on requirements for substances in articles' posted at this URL: <https://echa.europa.eu/guidance-documents/guidance-on-reach>

## Compatible Parts

 <p>TE Part # 794772-6 06P MINI UMNL SEAL, DIE CUT</p>	 <p>TE Part # 1586359-4 04P MINIUMNL GANG WIRE SEAL DR</p>	 <p>TE Part # 794772-2 02P MINI UMNL SEAL, DIE CUT</p>	 <p>TE Part # 794995-1 MINI UMNL CAVITY PLUG SEAL</p>
---	---	---	--



## Also in the Series | Mini-Universal MATE-N-LOK

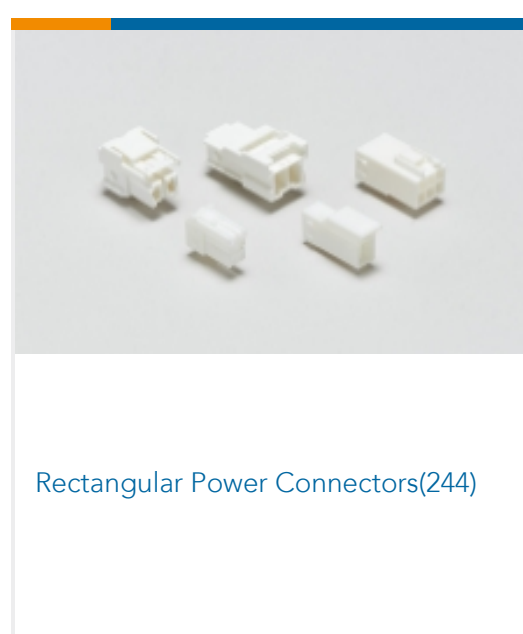
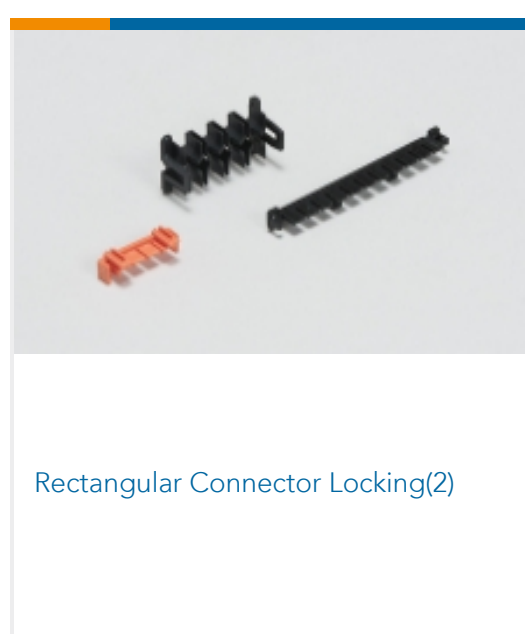
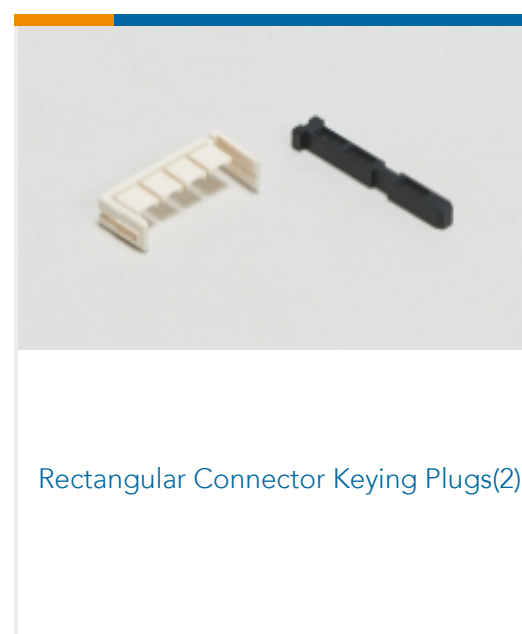
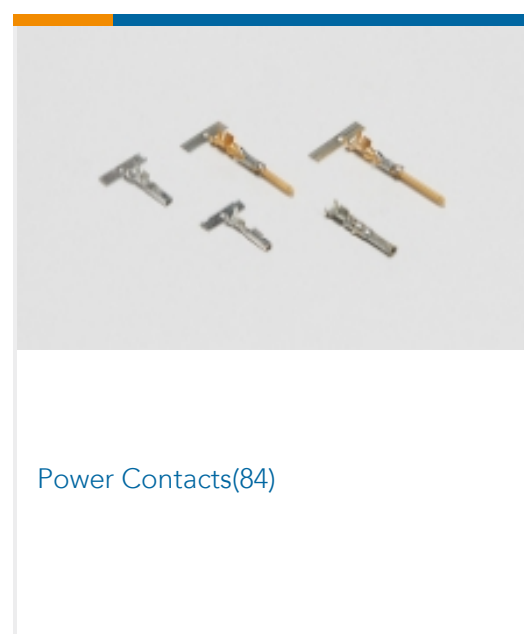
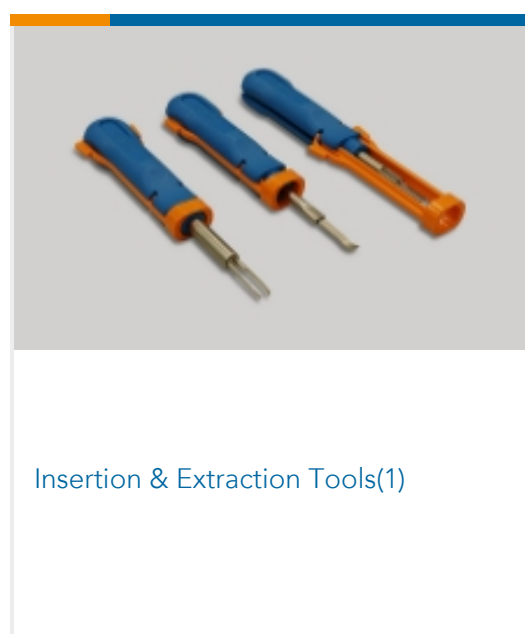
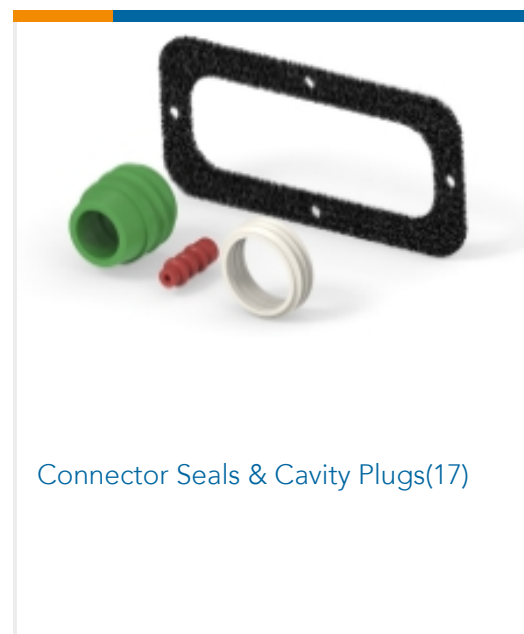
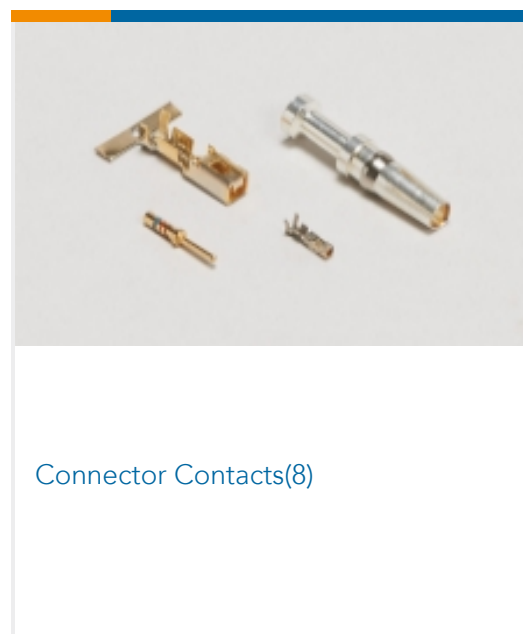
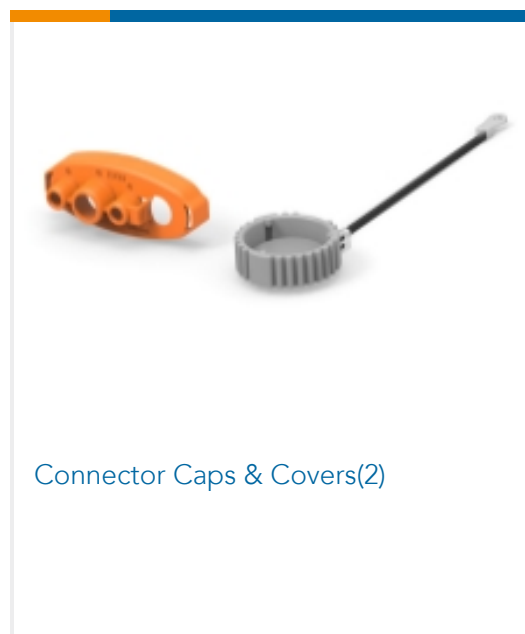

## Customers Also Bought

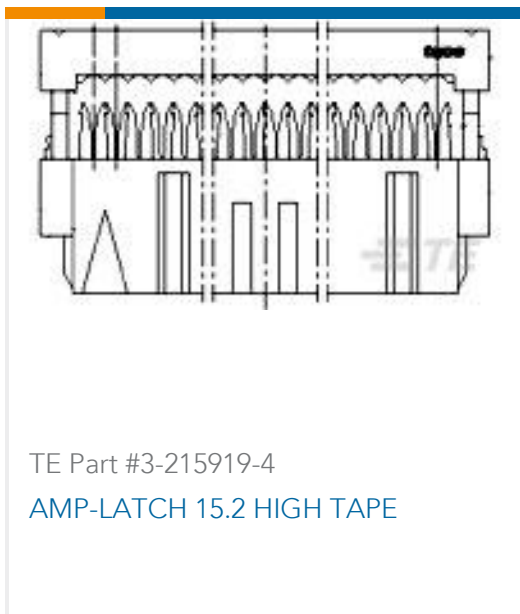
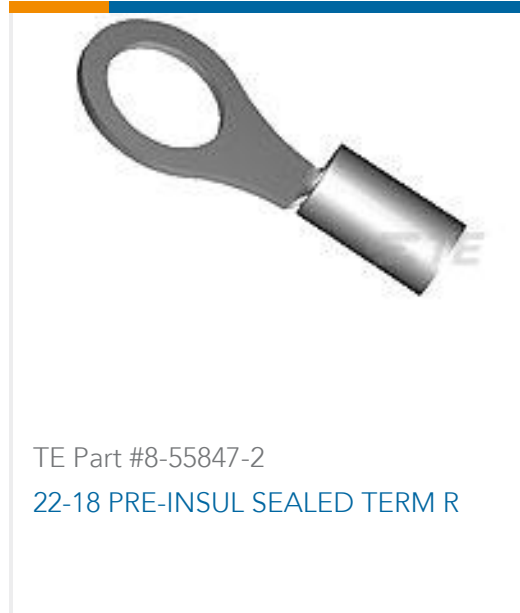

## Documents

### Product Drawings

[MINI UMNL WIRE SEAL, 18-26AWG](#)

English

### CAD Files

Customer View Model

[ENG\\_CVM\\_CVM\\_794758-1\\_D.2d\\_dxf.zip](#)

English

### 3D PDF

3D

Customer View Model

[ENG\\_CVM\\_CVM\\_794758-1\\_D.3d\\_igs.zip](#)

English

Customer View Model

[ENG\\_CVM\\_CVM\\_794758-1\\_D.3d\\_stp.zip](#)

English

By downloading the CAD file I accept and agree to the [Terms and Conditions](#) of use.

## Datasheets & Catalog Pages





## SOFT\_SHELL\_PIN\_AND\_SOCKET\_CONNECTORS\_CATALOG

English

---

### Product Specifications

Product Specification

English

Mini-Universal MATE-N-LOK\* Splash Proof Seals

English

Product Specification

English

Product Specification

English

---

### Product Environmental Compliance

Safety Datasheet

English

---

### Instruction Sheets

Instruction Sheet (U.S.)

English