

794072-1 ✓ ACTIVE

MATE-N-LOK | Mini-Universal MATE-N-LOK

TE Internal #: 794072-1

Rectangular Power Connectors, Header, Receptacle, Wire-to-Board, 24 Position, 4.14 mm [.162 in] Centerline, Mini-Universal MATE-N-LOK

[View on TE.com >](#)



Connectors > Power Connectors > Rectangular Power > Rectangular Power Connectors



Rectangular Power Connector Type: **Header**

Connector & Housing Type: **Receptacle**

Connector System: **Wire-to-Board**

Number of Positions: **24**

Centerline (Pitch): **4.14 mm [.162 in]**

Features

Product Type Features

Header Type	Fully Shrouded
Rectangular Power Connector Type	Header
Connector & Housing Type	Receptacle
Connector System	Wire-to-Board
Sealable	No
Connector & Contact Terminates To	Printed Circuit Board

Configuration Features

Number of Positions	24
PCB Mount Orientation	Vertical
Number of Power Positions	24
Number of Signal Positions	0
Number of Rows	2

Electrical Characteristics

Operating Voltage	600 VDC
-------------------	---------



Contact Features

Multiple Contact Types	Without
Contact Mating Area Plating Material	Tin-Lead
Contact Current Rating (Max)	9.5 A
Contact Retention Within Housing	Without
Contact Type	Pin
PCB Contact Termination Area Plating Material	Tin-Lead
Contact Mating Area Plating Material Thickness	3.81 – 6.35 μm [150 – 250 μin]

Termination Features

Termination Method to Printed Circuit Board	Through Hole - Solder
---------------------------------------------	-----------------------

Mechanical Attachment

Strain Relief	Without
Mating Alignment Type	Chamfered Edges
Mating Retention	With
Mating Alignment	With
PCB Mount Alignment	Without
Panel Mount Feature	Without
PCB Mount Retention	With
PCB Mount Retention Type	Boardlock
Mating Retention Type	Locking Tab
Connector Mounting Type	Board Mount

Housing Features

Centerline (Pitch)	4.14 mm[.162 in]
Housing Color	White
Housing Material	Nylon

Dimensions

Connector Height	9.83 mm
Product Width	13.49 mm
Product Length	51.23 mm
Wire Size	100.5 – 2853 CMA
Row-to-Row Spacing	4.14 mm[.163 in]

Usage Conditions



Operating Temperature Range	-55 – 105 °C[-67 – 221 °F]
-----------------------------	----------------------------

Operation/Application

Circuit Application	Power
---------------------	-------

Industry Standards

CSA Rating	Certified, LR 7189
UL Rating	Recognized
Agency/Standard	CSA, UL
Approved Standards	UL E28476
UL Flammability Rating	UL 94V-0
Glow Wire Rating	Standard Part - Not Glow Wire

Packaging Features

Packaging Quantity	200
Packaging Method	Bag

Product Compliance

[For compliance documentation, visit the product page on TE.com>](#)

EU RoHS Directive 2011/65/EU	Not Compliant
EU ELV Directive 2000/53/EC	Compliant with Exemptions
China RoHS 2 Directive MIIT Order No 32, 2016	Restricted Materials Above Threshold
EU REACH Regulation (EC) No. 1907/2006	Current ECHA Candidate List: JUNE 2023 (235) Candidate List Declared Against: JUNE 2023 (235) SVHC > Threshold: Pb (13% in Component Part) Article Safe Usage Statements: Do not eat, drink or smoke when using this product. Wash thoroughly after handling. Recycle if possible and dispose of the article by following all applicable governmental regulations relevant to your geographic location.
Halogen Content	Low Halogen - Br, Cl, F, I < 900 ppm per homogenous material. Also BFR/CFR/PVC Free
Solder Process Capability	Not lead free process capable

Product Compliance Disclaimer

This information is provided based on reasonable inquiry of our suppliers and represents our current actual knowledge based on the information they provided. This information is subject to change. The part numbers that TE has identified as EU RoHS compliant have a maximum concentration of 0.1% by weight in homogenous materials for lead, hexavalent chromium, mercury, PBB, PBDE, DBP, BBP, DEHP, DIBP, and 0.01% for cadmium, or qualify for an exemption to these limits as defined in the Annexes of Directive 2011/65/EU (RoHS2). Finished electrical and electronic equipment products will be CE marked as required by Directive 2011/65/EU. Components may not be CE marked. Additionally, the part numbers that TE has identified as EU ELV compliant have a maximum concentration of 0.1% by weight in homogenous

materials for lead, hexavalent chromium, and mercury, and 0.01% for cadmium, or qualify for an exemption to these limits as defined in the Annexes of Directive 2000/53/EC (ELV). Regarding the REACH Regulation, the information TE provides on SVHC in articles for this part number is based on the latest European Chemicals Agency (ECHA) 'Guidance on requirements for substances in articles' posted at this URL: <https://echa.europa.eu/guidance-documents/guidance-on-reach>

Compatible Parts

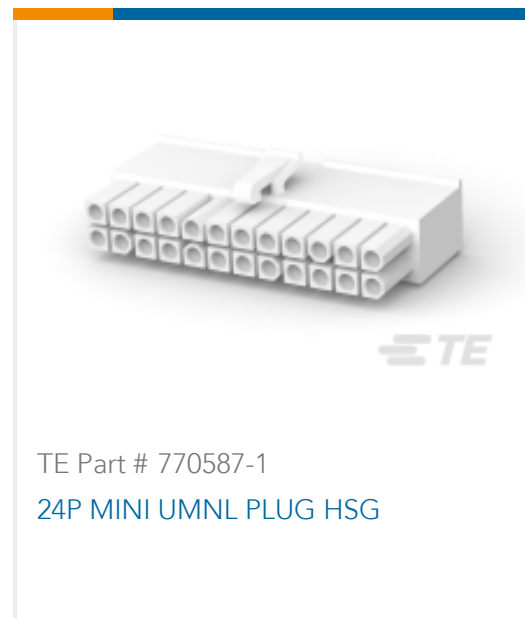

Also in the Series | Mini-Universal MATE-N-LOK

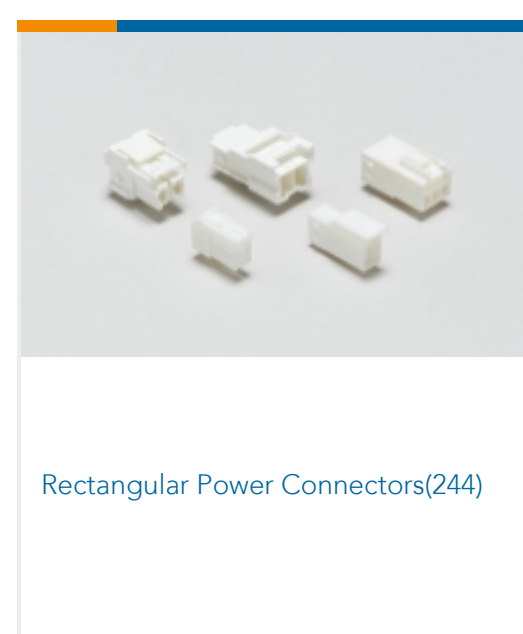
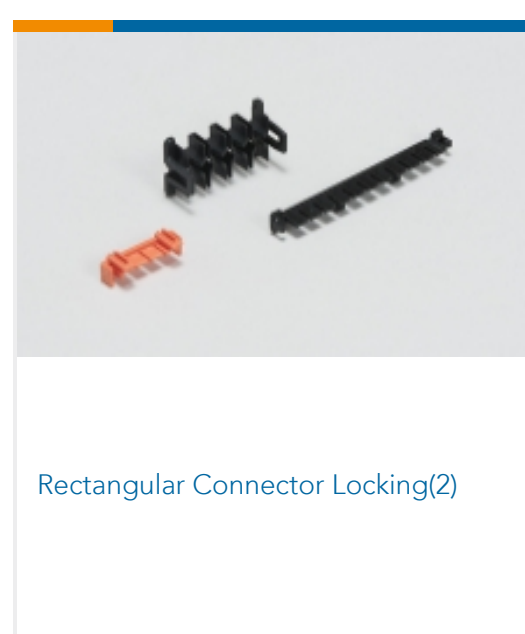
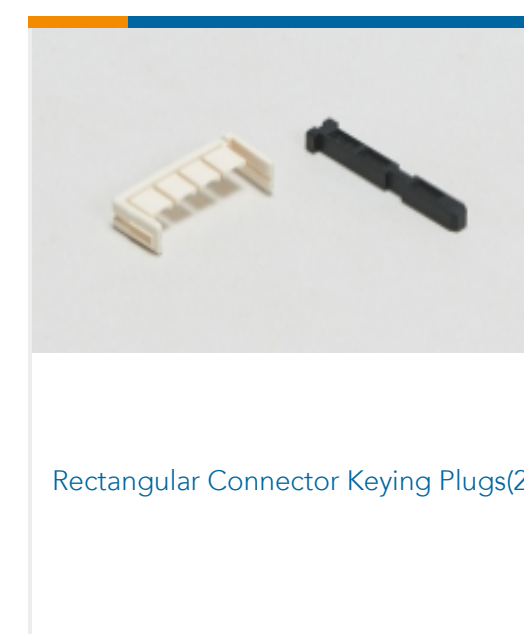
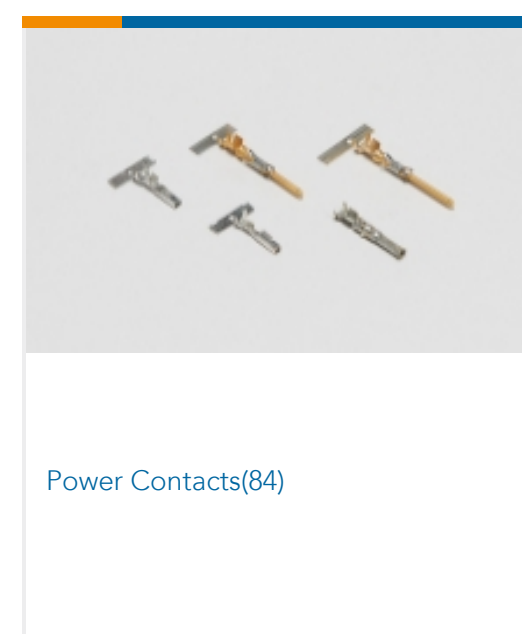
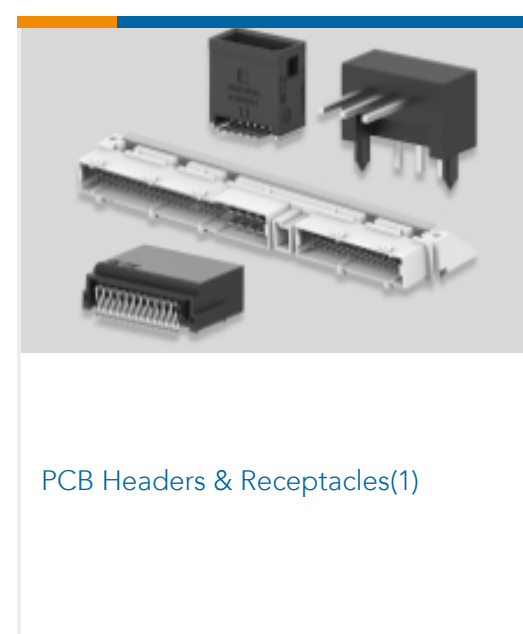
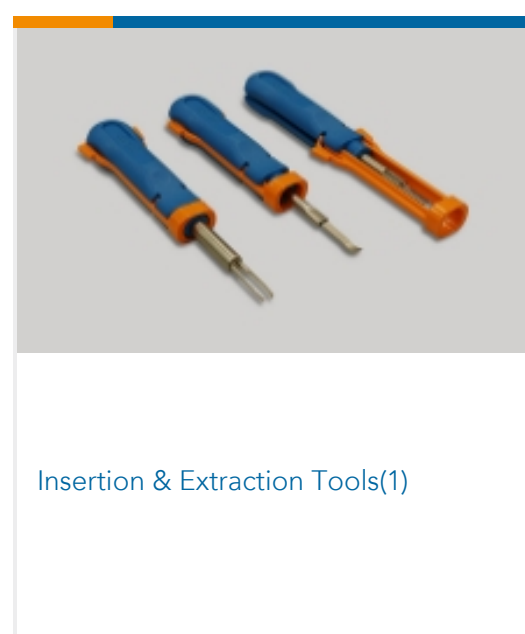
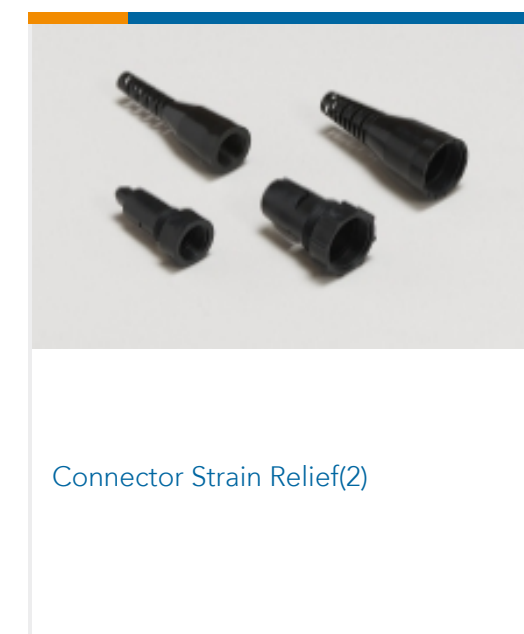
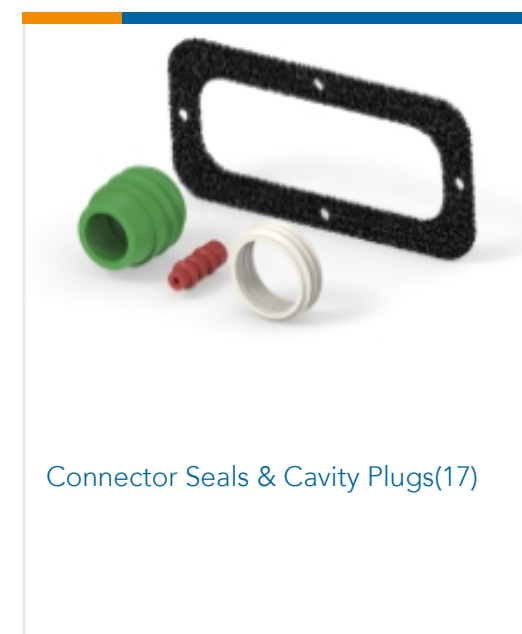
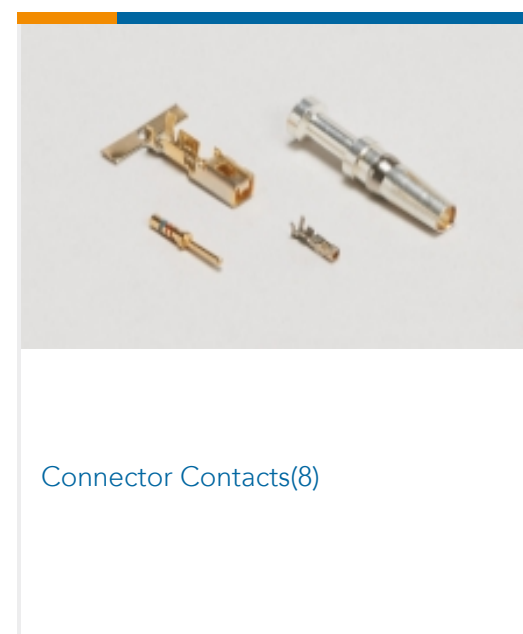
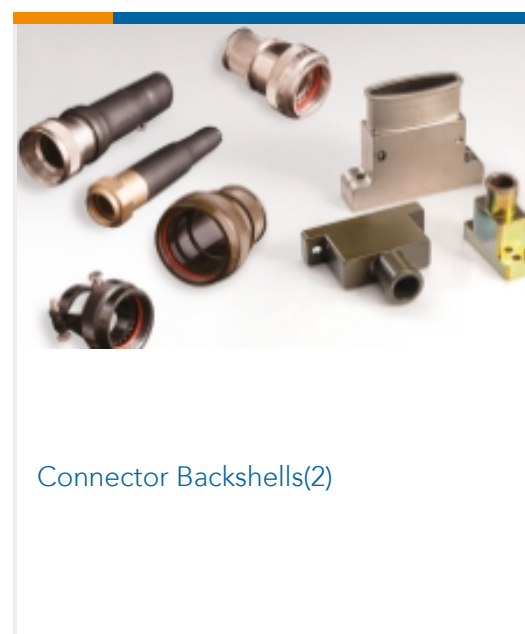

Customers Also Bought

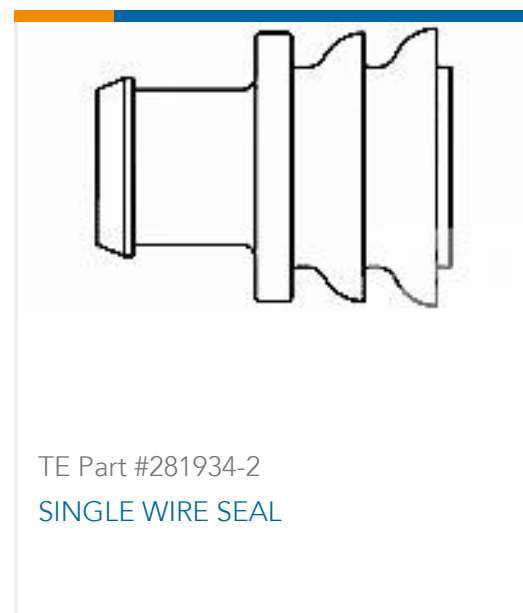

Documents

Product Drawings

24P MINI UMNL HDR W/DH SN

English

CAD Files

3D PDF

3D

Customer View Model

[ENG_CVM_CVM_794072-1_F.2d_dxf.zip](#)

English

Customer View Model

[ENG_CVM_CVM_794072-1_F.3d_igs.zip](#)

English

Customer View Model

[ENG_CVM_CVM_794072-1_F.3d_stp.zip](#)

English

By downloading the CAD file I accept and agree to the [Terms and Conditions](#) of use.

Datasheets & Catalog Pages

[SOFT_SHELL_PIN_AND_SOCKET_CONNECTORS_CATALOG](#)

English

Product Specifications

[Application Specification](#)

English

Product Environmental Compliance

[TE Material Declaration](#)



English

Instruction Sheets

Instruction Sheet (U.S.)

English

Instruction Sheet (U.S.)

English

Agency Approvals

UL

English