

776299-1 ✓ ACTIVE

AMP | AMPSEAL 16

TE Internal #: 776299-1

Automotive Terminals, Socket, 18 – 14 AWG Wire Size, .8 – 2 mm²

Wire Size, Gold (Au) Interface Plating, Terminates To Wire,

AMPSEAL 16

[View on TE.com >](#)



Terminals & Splices > Automotive Terminals > Contacts: Size 16, 13A

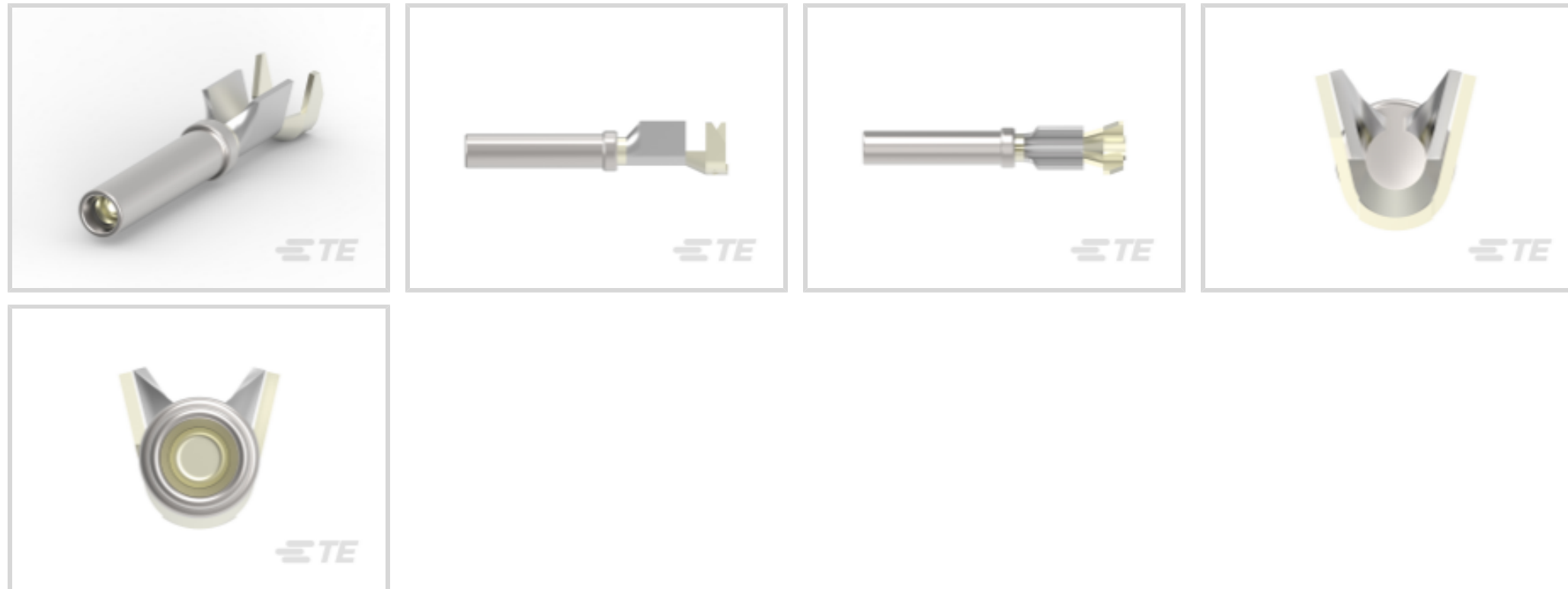

Terminal Type: **Socket**

Terminal Transmits: **0 – 24 A (Low Power)**

Wire Size: **.8 – 2 mm²**

Sealable: **No**

[All Contacts: Size 16, 13A \(33\)](#)

Features

Product Type Features

Sealable	No
----------	----

Contact Features

Contact Size	Size 16
Contact Fabrication	Stamped & Formed
Wire Contact Termination Area Plating Material	Tin
Crimp Type	F-Crimp
Terminal Type	Socket
Interface Plating	Gold (Au)

Termination Features

Termination Method to Wire & Cable	Crimp
Product Terminates To	Wire

Dimensions

Compatible Insulation Diameter Range	2.26 – 3.32 mm [.089 – .131 in]
--------------------------------------	---------------------------------



Wire Size	.8 – 2 mm ²
Wire Size Search	14 AWG, 15 AWG, 16 AWG, 17 AWG, 18 AWG

Usage Conditions

Insulation Option	Uninsulated
-------------------	-------------

Operation/Application

Compatible With Wire Base Material	Copper
------------------------------------	--------

Packaging Features

Packaging Quantity	1000
Packaging Method	Bag

Other

Customer Preferred Contact	No
Terminal Transmits	0 – 24 A (Low Power)

Product Compliance

[For compliance documentation, visit the product page on TE.com>](#)

EU RoHS Directive 2011/65/EU	Compliant
EU ELV Directive 2000/53/EC	Compliant
China RoHS 2 Directive MIIT Order No 32, 2016	No Restricted Materials Above Threshold
EU REACH Regulation (EC) No. 1907/2006	Current ECHA Candidate List: JUNE 2023 (235) Candidate List Declared Against: JUNE 2023 (235) Does not contain REACH SVHC
Halogen Content	Low Halogen - Br, Cl, F, I < 900 ppm per homogenous material. Also BFR/CFR/PVC Free
Solder Process Capability	Not applicable for solder process capability

Product Compliance Disclaimer

This information is provided based on reasonable inquiry of our suppliers and represents our current actual knowledge based on the information they provided. This information is subject to change. The part numbers that TE has identified as EU RoHS compliant have a maximum concentration of 0.1% by weight in homogenous materials for lead, hexavalent chromium, mercury, PBB, PBDE, DBP, BBP, DEHP, DIBP, and 0.01% for cadmium, or qualify for an exemption to these limits as defined in the Annexes of Directive 2011/65/EU (RoHS2). Finished electrical and electronic equipment products will be CE marked as required by Directive 2011/65/EU. Components may not be CE marked. Additionally, the part numbers that TE has identified as EU ELV compliant have a maximum concentration of 0.1% by weight in homogenous materials for lead, hexavalent chromium, and mercury, and 0.01% for cadmium, or qualify for an exemption to these limits as defined in the Annexes of Directive 2000/53/EC (ELV). Regarding the REACH Regulation, the information TE provides

on SVHC in articles for this part number is based on the latest European Chemicals Agency (ECHA) 'Guidance on requirements for substances in articles' posted at this URL: <https://echa.europa.eu/guidance-documents/guidance-on-reach>

Compatible Parts



TE Part # CAT-AM7801-CH8172
AMPSEAL 16 Housings



TE Part # 91337-1
SIZE 16 PRO-CRIMPER ASSY.

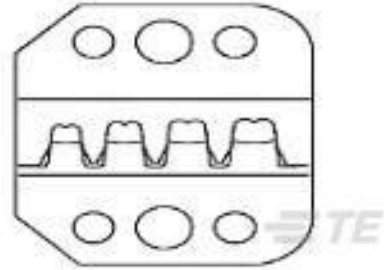

TE Part # 91337-2
SIZE 16 PRO-CRIMPER DIE

Also in the Series | AMPSEAL 16



Automotive Connector Caps & Covers (1)

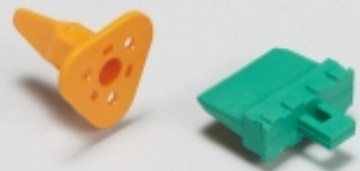

Automotive Connector Locks & Position Assurance(2)



Automotive Housings(244)



Automotive Terminals(33)



Connector Backshells(84)



Connector Seals & Cavity Plugs(4)



Data Connectivity Headers(2)



Data Connectivity Housings(3)



Other Automotive Connector Accessories(11)

Customers Also Bought

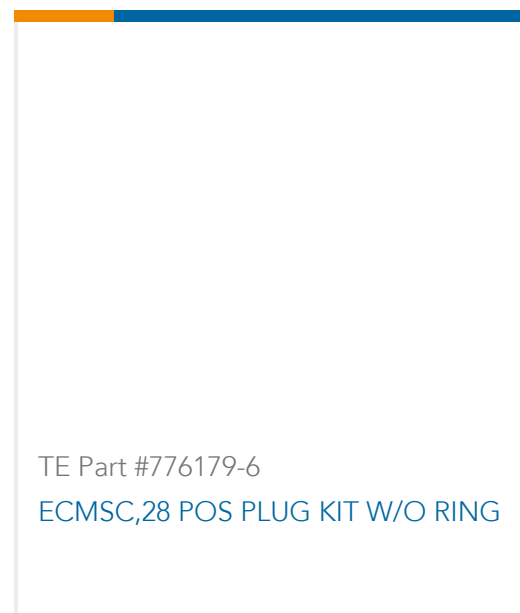

Documents

Product Drawings

[ASSEMBLY SOCKET LOOSE PC GOLD](#)

English

CAD Files

Customer View Model

[ENG_CVM_776299-1_A.3d_igs.zip](#)

English

Customer View Model

[ENG_CVM_776299-1_A.3d_stp.zip](#)

English

Customer View Model

[ENG_CVM_776299-1_A.2d_dxf.zip](#)

English

[3D PDF](#)

English

By downloading the CAD file I accept and agree to the [Terms and Conditions](#) of use.

Datasheets & Catalog Pages



[ICT Terminals and Connectors Catalogue](#)

English

[CONNECTOR SELECTOR](#)

English

[Product Specifications](#)

[Application Specification](#)

English