

776164-4 ✓ ACTIVE

AMP | AMPSEAL

TE Internal #: 776164-4

Housing for Female Terminals, Wire-to-Board, 35 Position, .157 in [4 mm] Centerline, Sealable, Gray, Power & Signal, AMPSEAL

[View on TE.com >](#)



Connectors > Automotive Connectors > Automotive Housings > AMPSEAL Receptacle Housings

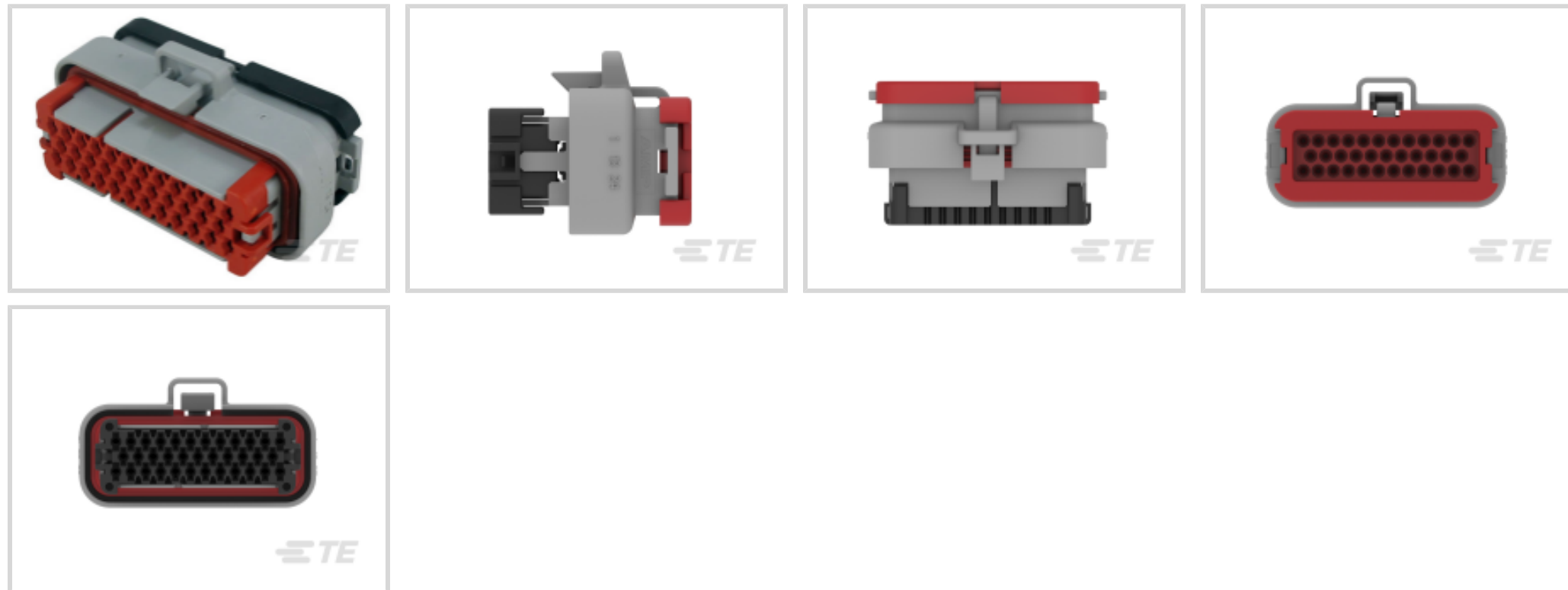

Connector System: **Wire-to-Board**

Number of Positions: **35**

Connector & Housing Type: **Housing for Female Terminals**

Centerline (Pitch): **4 mm [.157 in]**

Sealable: **Yes**

[All AMPSEAL Receptacle Housings \(31\)](#)

Features

Product Type Features

Mixed & Hybrid Connector	No
Connector Shape	Rectangular
Connector System	Wire-to-Board
Connector & Housing Type	Housing for Female Terminals
Sealable	Yes
Primary Locking Feature	Integrated in Housing

Configuration Features

Number of Positions	35
Number of Rows	3

Electrical Characteristics

Operating Voltage	250 VAC
Nominal Voltage Architecture	250 V

Body Features



Cable Exit Angle	180°
Primary Product Color	Gray
Connector & Keying Code	4

Contact Features

Contact Size	1.3mm
Contact Type	Socket
Mating Pin Diameter	1.3 mm[.051 in]
Contact Current Rating (Max)	17 A

Mechanical Attachment

Terminal Position Assurance	Yes
Strain Relief	Add By Accessory
Mating Alignment Type	Keyed
Mating Alignment	With
Connector Mounting Type	Cable Mount (Free-Hanging)

Housing Features

Housing Material	PBT GF
Centerline (Pitch)	4 mm[.157 in]

Dimensions

Connector Height	34.6 mm[1.362 in]
Product Width	33.6 mm[1.323 in]
Product Length	63.4 mm[2.496 in]
Row-to-Row Spacing	4 mm[.157 in]

Usage Conditions

Operating Temperature (Max)	125 °C[257 °F]
Operating Temperature Range	-40 – 125 °C[-40 – 257 °F]

Operation/Application

Circuit Application	Power & Signal
---------------------	----------------

Industry Standards

Degree of Protection	IP67, IP69K
UL Flammability Rating	UL 94V-0

Packaging Features

Packaging Quantity	140
--------------------	-----



Packaging Method	Box & Tray
------------------	------------

Other

Serviceable	Yes
Connector Position Assurance Capable	Yes

Product Compliance

[For compliance documentation, visit the product page on TE.com>](#)

EU RoHS Directive 2011/65/EU	Compliant
EU ELV Directive 2000/53/EC	Compliant
China RoHS 2 Directive MIIT Order No 32, 2016	No Restricted Materials Above Threshold
EU REACH Regulation (EC) No. 1907/2006	<p>Current ECHA Candidate List: JUNE 2023 (235)</p> <p>Candidate List Declared Against: JUNE 2023 (235)</p> <p>SVHC > Threshold:</p> <p>Octamethylcyclotetrasiloxane (D4) (.5% in Component Part)</p> <p>Dodecamethylcyclohexasiloxane (D6) (.5% in Component Part)</p> <p>Decamethylcyclopentasiloxane (D5) (.5% in Component Part)</p> <p>Article Safe Usage Statements: Wash thoroughly after handling. Recycle if possible and dispose of the article by following all applicable governmental regulations relevant to your geographic location.</p>
Halogen Content	Not Low Halogen - contains Br or Cl > 900 ppm.
Solder Process Capability	Not applicable for solder process capability

Product Compliance Disclaimer

This information is provided based on reasonable inquiry of our suppliers and represents our current actual knowledge based on the information they provided. This information is subject to change. The part numbers that TE has identified as EU RoHS compliant have a maximum concentration of 0.1% by weight in homogenous materials for lead, hexavalent chromium, mercury, PBB, PBDE, DBP, BBP, DEHP, DIBP, and 0.01% for cadmium, or qualify for an exemption to these limits as defined in the Annexes of Directive 2011/65/EU (RoHS2). Finished electrical and electronic equipment products will be CE marked as required by Directive 2011/65/EU. Components may not be CE marked. Additionally, the part numbers that TE has identified as EU ELV compliant have a maximum concentration of 0.1% by weight in homogenous materials for lead, hexavalent chromium, and mercury, and 0.01% for cadmium, or qualify for an exemption to these limits as defined in the Annexes of Directive 2000/53/EC (ELV). Regarding the REACH Regulation, the information TE provides on SVHC in articles for this part number is based on the latest European Chemicals Agency (ECHA) 'Guidance on requirements for substances in articles' posted at this URL: <https://echa.europa.eu/guidance-documents/guidance-on-reach>

Compatible Parts



TE Part # CAT-AM78-H342
AMPSEAL PCB Headers



TE Part # CAT-J04-APHH
AMPSEAL PCB Horizontal Headers



TE Part # CAT-AM78-T273
AMPSEAL Crimp Contacts: 1.3 mm



TE Part # 770678-1
SEAL PLUG, AMPSEAL



TE Part # 776180-4
35POS,PIN DIA 1.3,HDR ASSY,90DEG, COD 4



TE Part # CAT-AM78-B128
AMPSEAL Backshells



TE Part # 2373965-1
CPA,AMPSEAL

Also in the Series | AMPSEAL

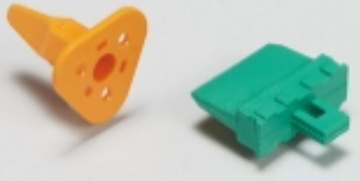

Automotive Connector Locks & Position Assurance(1)



Automotive Housings(31)



Automotive Terminals(8)



Connector Backshells(5)



Connector Seals & Cavity Plugs(1)



PCB Headers & Receptacles(115)

Customers Also Bought



TE Part #776164-1
AMPSEAL Receptacle Housings

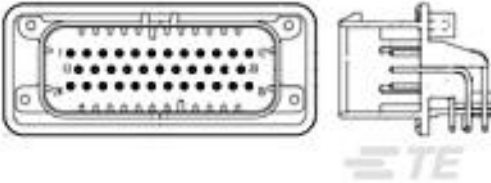

TE Part #776163-4
35POS,PIN DIA 1.3,HDR ASSY,90DEG, COD 4



TE Part #HD36-24-23ST-059
DEUTSCH HD30 Housings



TE Part #K1060046
Relay 30-211-02



Documents

CAD Files

Customer View Model

[ENG_CVM_CVM_776164-4_F.2d_dxf.zip](#)

English

3D PDF

3D

Customer View Model

[ENG_CVM_CVM_776164-4_F.3d_igs.zip](#)

English

Customer View Model

[ENG_CVM_CVM_776164-4_F.3d_stp.zip](#)

English

By downloading the CAD file I accept and agree to the [Terms and Conditions](#) of use.

Datasheets & Catalog Pages

AMPSEAL Connector Catalog

English

ICT Terminals and Connectors Catalogue

English

Product Specifications

Application Specification

English

Instruction Sheets

Instruction Sheet (U.S.)

English

Agency Approvals

UL Report

English