



MATE-N-LOK | Mini-Universal MATE-N-LOK

TE Internal #: 770834-4

Power Contacts, Contact, 600 VAC, 600 VDC, Tin, 30 – 26 AWG
 Wire Size, .05 – .15 mm² Wire Size, Wire & Cable, Crimp, Power,
 Mini-Universal MATE-N-LOK

[View on TE.com >](#)

Connectors > Power Connectors > Power Contacts

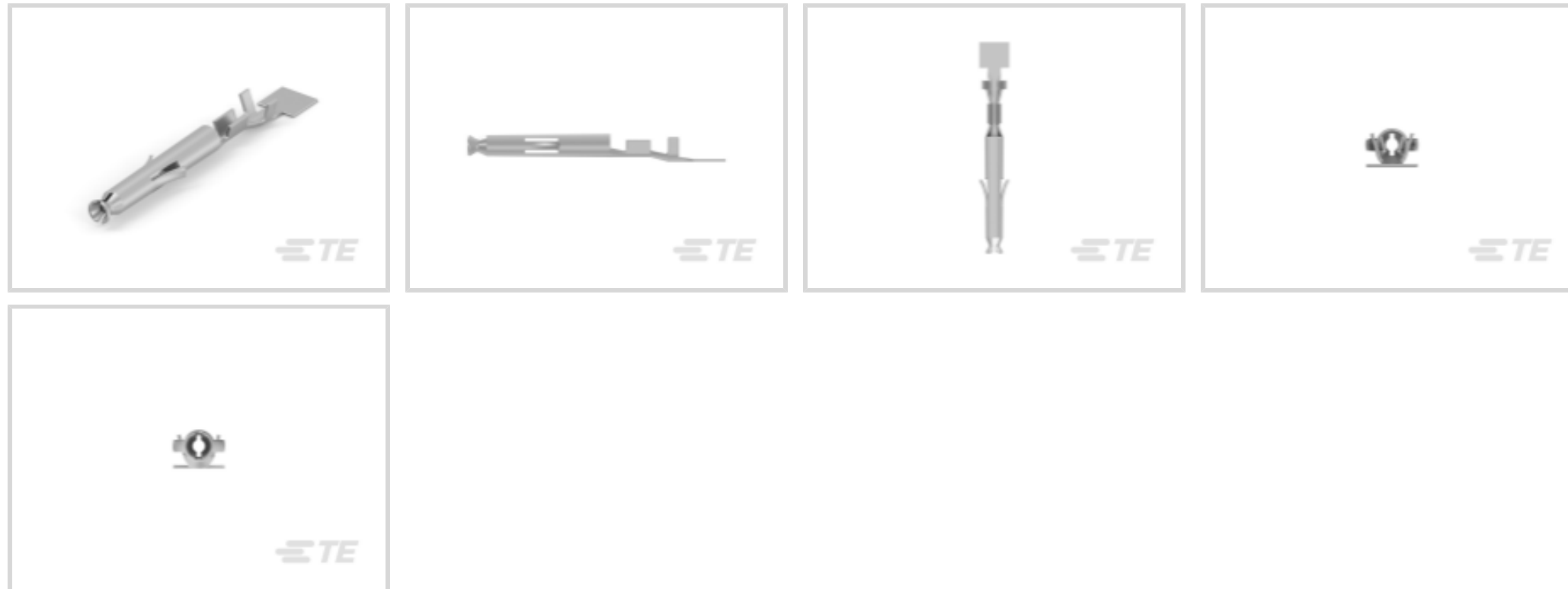

Power Contact Type: **Contact**

Operating Voltage: **600 VDC**

Contact Mating Area Plating Material: **Tin**

Wire Size: **30 – 26 AWG**

Features

Product Type Features

Compatible With Discrete Wire Type	Stranded
Power Contact Type	Contact
Connector & Contact Terminates To	Wire & Cable

Electrical Characteristics

Operating Voltage	600 VDC
-------------------	---------

Contact Features

Contact Mating Area Plating Material	Tin
Contact Current Rating (Max)	11.2 A
Contact Type	Socket
Contact Retention Within Housing	With
Mating Pin Diameter	1 mm [.039 in]
Contact Base Material	Phosphor Bronze
Wire Contact Termination Area Plating Thickness	.4 μm [15.74 μin]
Wire Contact Termination Area Plating Material	Pre-Tin
Wire Contact Termination Area Plating Material Finish	Matte



Contact Orientation	Straight
---------------------	----------

Termination Features

Termination Method to Wire & Cable	Crimp
------------------------------------	-------

Mechanical Attachment

Wire Insulation Support	Without
-------------------------	---------

Dimensions

Wire Size	.05 – .15 mm ²
-----------	---------------------------

Compatible Insulation Diameter Range	.89 – 1.27 mm [.035 – .05 in]
--------------------------------------	-------------------------------

Usage Conditions

Operating Temperature Range	-55 – 105 °C [-67 – 221 °F]
-----------------------------	-----------------------------

Operation/Application

Circuit Application	Power
---------------------	-------

Industry Standards

CSA Rating	Certified, LR 7189
------------	--------------------

UL Rating	Recognized
-----------	------------

Agency/Standard	CSA, UL
-----------------	---------

UL Flammability Rating	UL 94V-0
------------------------	----------

Packaging Features

Packaging Quantity	10000
--------------------	-------

Packaging Method	Reel
------------------	------

Other

Power Connectors Comment	HDM Applicator part number ending in -1 is used on AMPOMATOR CLS Machine with T or G Terminators, -2 is used on AMP-O-ELECTRIC Model K Machine, -3 is used on AMP-O-ELECTRIC Model G Machine.
--------------------------	---

Product Compliance

For compliance documentation, visit the product page on [TE.com](https://www.te.com)>

EU RoHS Directive 2011/65/EU	Compliant
------------------------------	-----------

EU ELV Directive 2000/53/EC	Compliant
-----------------------------	-----------

China RoHS 2 Directive MIIT Order No 32, 2016	No Restricted Materials Above Threshold
---	---

EU REACH Regulation (EC) No. 1907/2006	
--	--



Current ECHA Candidate List: JUNE 2023 (235)
 Candidate List Declared Against: JUNE 2023 (235)
 Does not contain REACH SVHC

Halogen Content
 Low Halogen - Br, Cl, F, I < 900 ppm per homogenous material. Also BFR/CFR/PVC Free

Solder Process Capability
 Not applicable for solder process capability

Product Compliance Disclaimer

This information is provided based on reasonable inquiry of our suppliers and represents our current actual knowledge based on the information they provided. This information is subject to change. The part numbers that TE has identified as EU RoHS compliant have a maximum concentration of 0.1% by weight in homogenous materials for lead, hexavalent chromium, mercury, PBB, PBDE, DBP, BBP, DEHP, DIBP, and 0.01% for cadmium, or qualify for an exemption to these limits as defined in the Annexes of Directive 2011/65/EU (RoHS2). Finished electrical and electronic equipment products will be CE marked as required by Directive 2011/65/EU. Components may not be CE marked. Additionally, the part numbers that TE has identified as EU ELV compliant have a maximum concentration of 0.1% by weight in homogenous materials for lead, hexavalent chromium, and mercury, and 0.01% for cadmium, or qualify for an exemption to these limits as defined in the Annexes of Directive 2000/53/EC (ELV). Regarding the REACH Regulation, the information TE provides on SVHC in articles for this part number is based on the latest European Chemicals Agency (ECHA) 'Guidance on requirements for substances in articles' posted at this URL: <https://echa.europa.eu/guidance-documents/guidance-on-reach>

Compatible Parts

TE Part # CAT-AM71-C83998EE
 Mini Circular Plastic Connectors (CPC)

TE Part # 189727-1
 EXTRACTION TOOL

TE Part # 455830-1
 INSERTION TOOL

TE Part # 770586-1
 22P MINI UMNL PLUG HSG

TE Part # 770587-1
 24P MINI UMNL PLUG HSG

TE Part # 770582-1
 14P MINI UMNL PLUG HSG

TE Part # 770585-1
 20P MINI UMNL PLUG HSG

TE Part # 172333-1
 MINI UNIVERSAL M-N-L HOUSING



Also in the Series | Mini-Universal MATE-N-LOK

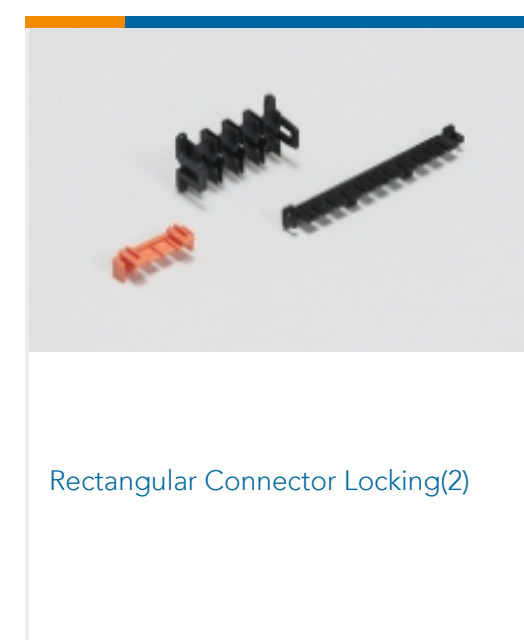
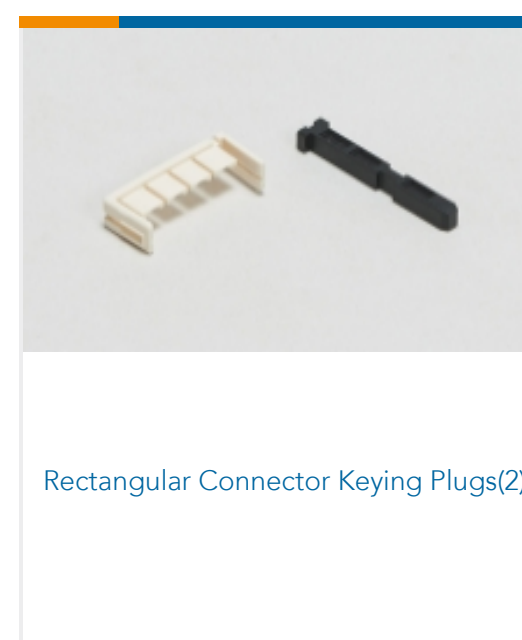
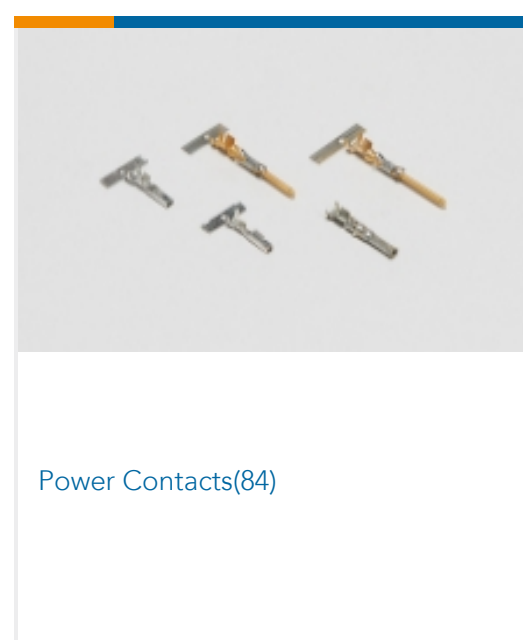
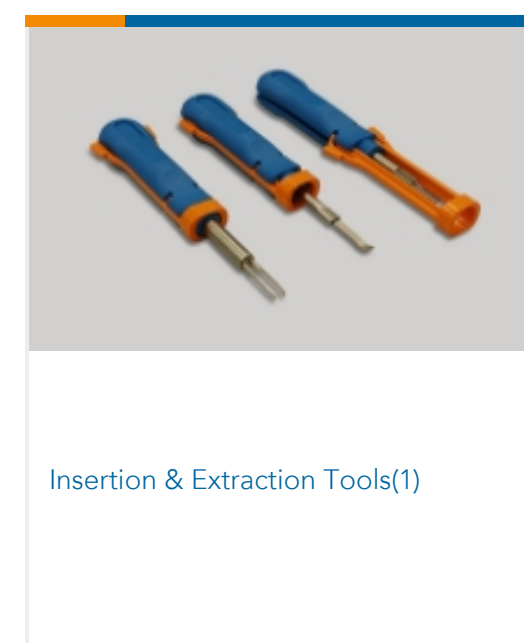
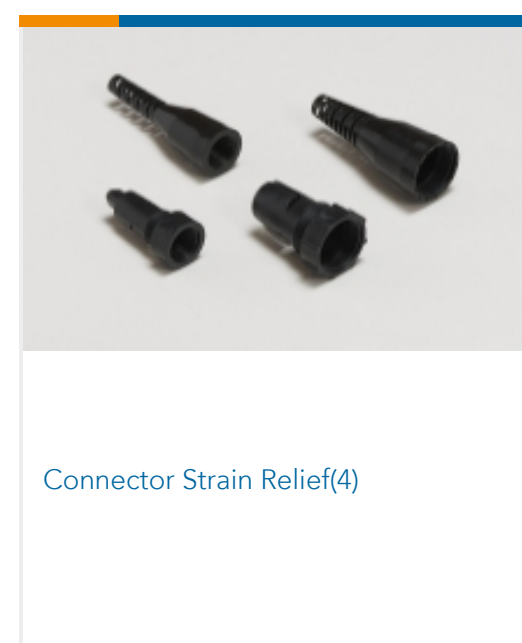
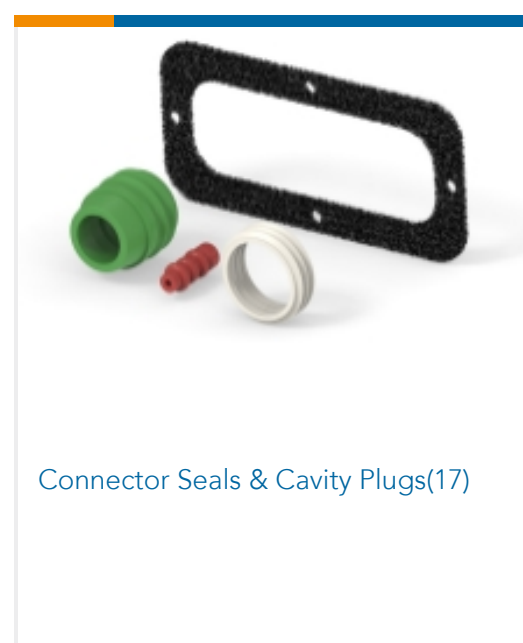
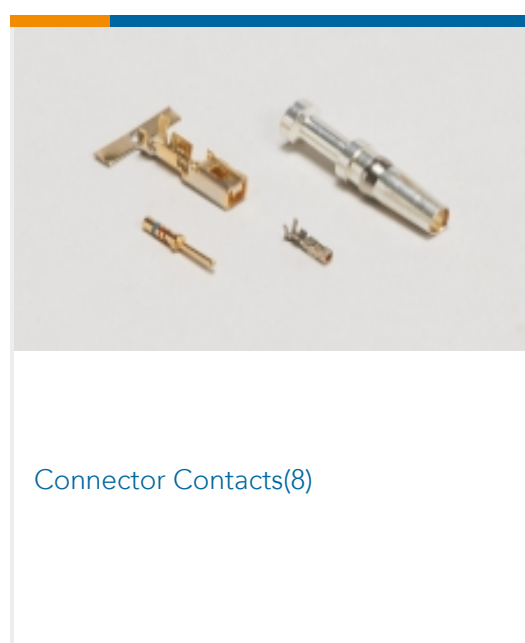



Rectangular Power Connectors(244)

Customers Also Bought

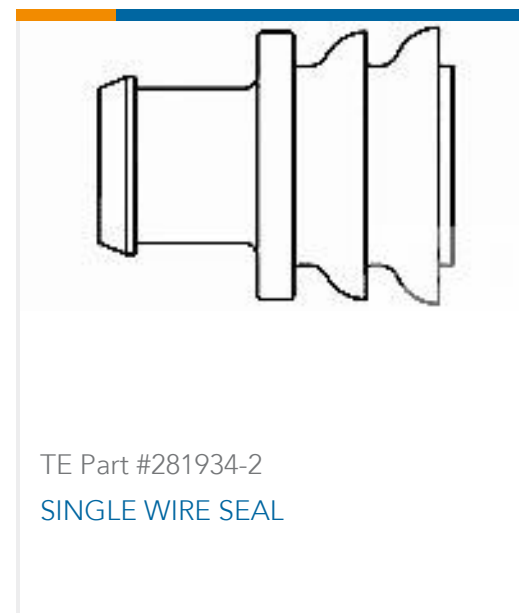
TE Part #206070-8
CABLE CLAMP KIT #17TE Part #DT04-2P
REC, 2P, GRY, NTE Part #DT06-2S
PLG, 2P, GRY, NTE Part #W2P
Wedgelocks: DEUTSCH DTTE Part #0462-201-16141
DEUTSCH Solid ContactsTE Part #282080-1
AMP SUPERSEAL 1.5MM,
CONNECTOR HOUSINGTE Part #281934-2
SINGLE WIRE SEAL

Documents

Product Drawings

MINI UMNL SOCKET PHBR

English

CAD Files

3D PDF

3D

Customer View Model

[ENG_CVM_CVM_770834-4_V.2d_dxf.zip](#)

English

Customer View Model

[ENG_CVM_CVM_770834-4_V.3d_igs.zip](#)

English

Customer View Model

[ENG_CVM_CVM_770834-4_V.3d_stp.zip](#)

English

Customer View Model



[ENG_CVM_770834-4_P.3d_igs.zip](#)

English

Customer View Model

[ENG_CVM_770834-4_P.3d_stp.zip](#)

English

Customer View Model

[ENG_CVM_770834-4_P.2d_dxf.zip](#)

English

3D PDF

English

By downloading the CAD file I accept and agree to the [Terms and Conditions](#) of use.

Datasheets & Catalog Pages

[AMP Circular Connectors for Commercial Signal & Power Applications Continued](#)

English

[SOFT_SHELL_PIN_AND_SOCKET_CONNECTORS_CATALOG](#)

English

Product Specifications

[Application Specification](#)

English

Product Environmental Compliance

[Product Compliance](#)

English

[Product Compliance](#)

English

Instruction Sheets

[Instruction Sheet \(U.S.\)](#)

English