

770520-1 ✓ ACTIVE

AMP | AMPSEAL

TE Internal #: 770520-1

Automotive Terminals, Socket, Pin Diameter 1.3 mm [.051 in], 20 – 16 AWG Wire Size, .5 – 1.5 mm² Wire Size, Family Seal, AMPSEAL

[View on TE.com >](#)



Terminals & Splices > Automotive Terminals > AMPSEAL Crimp Contacts: 1.3 mm



Terminal Type: **Socket**

Mating Pin Diameter: **1.3 mm [.051 in]**

Terminal Transmits: **0 – 24 A (Low Power)**

Wire Size: **.5 – 1.5 mm²**

[All AMPSEAL Crimp Contacts: 1.3 mm \(8\)](#)

Features

Product Type Features

Receptacle Style	180°
Sealable	No
Primary Locking Feature	On the Terminal

Body Features

Terminal Seal Type	Family Seal
--------------------	-------------

Contact Features

Contact Size	1.3mm
Contact Fabrication	Stamped & Formed
Typical Current Rating	8 A
Crimp Type	F-Crimp
Terminal Type	Socket
Mating Pin Diameter	1.3 mm [.051 in]
Interface Plating	Tin (Sn)

Termination Features

Termination Method to Wire & Cable	Crimp
Product Terminates To	Wire

Dimensions



Compatible Insulation Diameter Range	1.7 – 2.7 mm [.067 – .106 in]
Wire Size	.5 – 1.5 mm ²
Wire Size Search	16 AWG, 18 AWG, 20 AWG

Usage Conditions

Insulation Option	Uninsulated
Operating Temperature (Max)	125 °C [257 °F]
Operating Temperature Range	-40 – 125 °C [-40 – 257 °F]

Operation/Application

Compatible With Wire Base Material	Copper
------------------------------------	--------

Packaging Features

Packaging Quantity	5000
Packaging Method	Reel

Other

Terminal Transmits	0 – 24 A (Low Power)
--------------------	----------------------

Product Compliance

[For compliance documentation, visit the product page on TE.com>](#)

EU RoHS Directive 2011/65/EU	Compliant
EU ELV Directive 2000/53/EC	Compliant
China RoHS 2 Directive MIIT Order No 32, 2016	No Restricted Materials Above Threshold
EU REACH Regulation (EC) No. 1907/2006	Current ECHA Candidate List: JUNE 2023 (235) Candidate List Declared Against: JUNE 2023 (235) Does not contain REACH SVHC
Halogen Content	Low Halogen - Br, Cl, F, I < 900 ppm per homogenous material. Also BFR/CFR/PVC Free
Solder Process Capability	Not reviewed for solder process capability

Product Compliance Disclaimer

This information is provided based on reasonable inquiry of our suppliers and represents our current actual knowledge based on the information they provided. This information is subject to change. The part numbers that TE has identified as EU RoHS compliant have a maximum concentration of 0.1% by weight in homogenous materials for lead, hexavalent chromium, mercury, PBB, PBDE, DBP, BBP, DEHP, DIBP, and 0.01% for cadmium, or qualify for an exemption to these limits as defined in the Annexes of Directive 2011/65/EU (RoHS2). Finished electrical and electronic equipment products will be CE marked as required by Directive 2011/65/EU. Components may not be CE marked. Additionally, the part numbers that TE has identified as EU ELV compliant have a maximum concentration of 0.1% by weight in homogenous materials for lead, hexavalent chromium, and mercury, and 0.01% for cadmium, or qualify for an exemption to these limits

as defined in the Annexes of Directive 2000/53/EC (ELV). Regarding the REACH Regulation, the information TE provides on SVHC in articles for this part number is based on the latest European Chemicals Agency (ECHA) 'Guidance on requirements for substances in articles' posted at this URL: <https://echa.europa.eu/guidance-documents/guidance-on-reach>

Compatible Parts



TE Part # CAT-AM78-CH8172
AMPSEAL Receptacle Housings



TE Part # 58529-1
PRO-CRIMPER III TOOL AMPSEAL

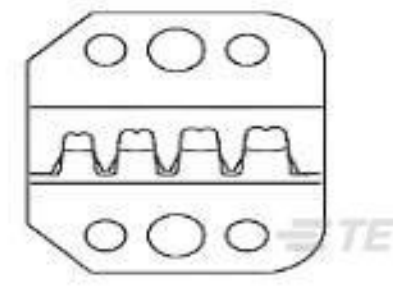

TE Part # 58529-2
PROCIMP DIE AMPSEAL



TE Part # 2217748-1
CCII AMPSEAL CONT 20-16 ASSY



TE Part # 2305570-1
Strip Terminal Cutter-Side Feed-No Crimp



TE Part # 2151376-1
OCEAN_2.0_Applicator-S-080F1200



TE Part # 2151376-2
OCEAN_2.0_Applicator-S-080F1200



TE Part # 7-2151376-1
OCEAN_2.0_Applicator-S-080F1200



TE Part # 7-2151376-2
OCEAN_2.0_Applicator-S-080F1200



TE Part # 7-2151376-7
OCEAN_2.0_SPARE_PART_KIT-080F1200



TE Part # 2-2151376-1
OCEAN_2.0_Applicator-S-080F1200

Also in the Series | AMPSEAL

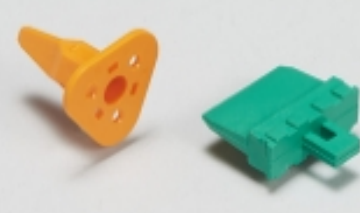

Automotive Connector Locks & Position Assurance(1)



Automotive Housings(31)



Automotive Terminals(8)



Connector Backshells(5)

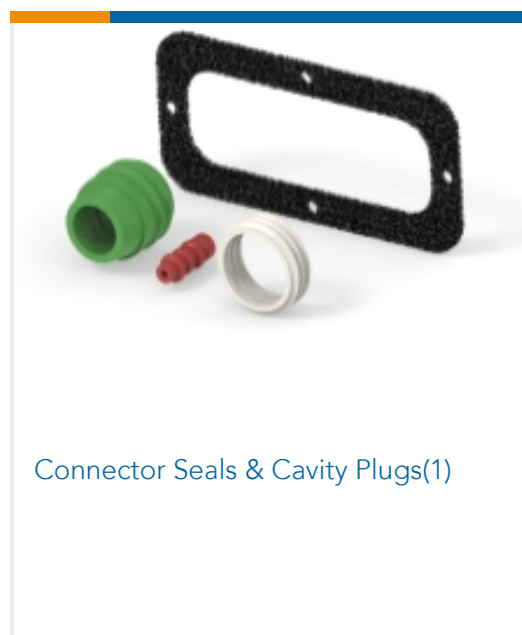

Customers Also Bought

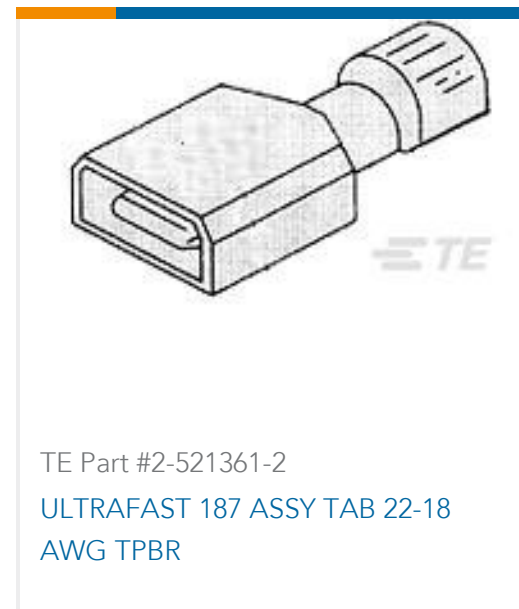
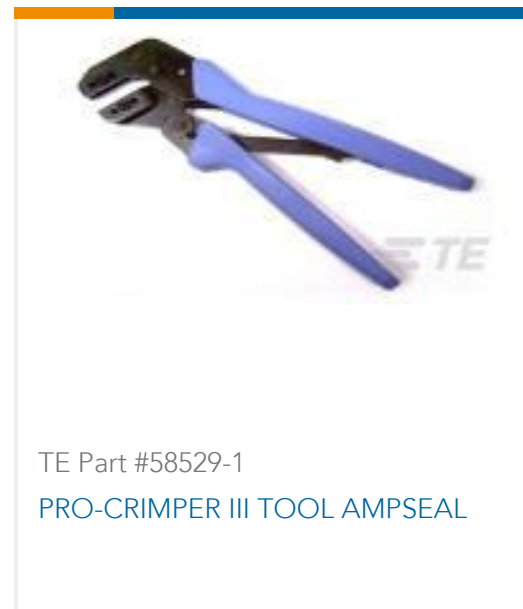

Documents

Product Drawings

AMPSEAL,TERMINAL,TIN PLATE,16-20AWG WIRE

English

CAD Files

3D PDF

3D

Customer View Model

[ENG_CVM_CVM_770520-1_P1.2d_dxf.zip](#)

English

Customer View Model

[ENG_CVM_CVM_770520-1_P1.3d_igs.zip](#)

English

Customer View Model

[ENG_CVM_CVM_770520-1_P1.3d_stp.zip](#)

English

By downloading the CAD file I accept and agree to the [Terms and Conditions](#) of use.



Datasheets & Catalog Pages

[AMPSEAL Connector Catalog](#)

English

[ICT Terminals and Connectors Catalogue](#)

English

[CONNECTOR SELECTOR](#)

English

Product Specifications

[Application Specification](#)

English

Product Environmental Compliance

[MD_770520-1_071420161251_dmtec](#)

English

[MD_770520-1_071420161251_dmtec](#)

English

Instruction Sheets

[Instruction Sheet \(U.S.\)](#)

English

[INSTRUCTION SHEET, AMPSEAL AUTOMOTIVE CONTACT 770520](#)

English