



Connectors > Power Connectors > Power Contacts

Power Contact Type: **Contact**Operating Voltage: **250 VAC, 600 VAC**Contact Mating Area Plating Material: **Tin**Wire Size: **.2 – .82 mm²**

Features

Product Type Features

Compatible With Discrete Wire Type	Stranded
Power Contact Type	Contact
Connector & Contact Terminates To	Wire & Cable

Electrical Characteristics

Operating Voltage	250 VAC, 600 VAC
-------------------	------------------

Contact Features

Contact Mating Area Plating Material	Tin
Contact Current Rating (Max)	13 A
Contact Type	Socket
Contact Retention Within Housing	With
Mating Pin Diameter	2.36 mm[.093 in]
Contact Base Material	Brass
Wire Contact Termination Area Plating Thickness	.4 μm[15.74 μin]
Wire Contact Termination Area Plating Material	Pre-Tin
Contact Orientation	Straight



Termination Features

Termination Method to Wire & Cable	Crimp
------------------------------------	-------

Mechanical Attachment

Contact Retention Type Within Housing	Locking Lance
Wire Insulation Support	Without

Dimensions

Wire Size	.2 – .82 mm ²
Compatible Insulation Diameter Range	2.79 mm[.11 in]

Usage Conditions

Operating Temperature Range	-55 – 105 °C[-67 – 221 °F]
-----------------------------	----------------------------

Operation/Application

Circuit Application	Power
---------------------	-------

Packaging Features

Packaging Quantity	1000
Packaging Method	Bag

Product Compliance

[For compliance documentation, visit the product page on TE.com>](#)

EU RoHS Directive 2011/65/EU	Compliant
EU ELV Directive 2000/53/EC	Compliant
China RoHS 2 Directive MIIT Order No 32, 2016	No Restricted Materials Above Threshold
EU REACH Regulation (EC) No. 1907/2006	Current ECHA Candidate List: JUNE 2023 (235) Candidate List Declared Against: JUNE 2023 (235) Does not contain REACH SVHC
Halogen Content	Low Halogen - Br, Cl, F, I < 900 ppm per homogenous material. Also BFR/CFR/PVC Free
Solder Process Capability	Not applicable for solder process capability

Product Compliance Disclaimer

This information is provided based on reasonable inquiry of our suppliers and represents our current actual knowledge based on the information they provided. This information is subject to change. The part numbers that TE has identified as EU RoHS compliant have a maximum concentration of 0.1% by weight in homogenous materials for lead, hexavalent chromium, mercury, PBB, PBDE, DBP, BBP, DEHP, DIBP, and 0.01% for cadmium, or qualify for an exemption to these

limits as defined in the Annexes of Directive 2011/65/EU (RoHS2). Finished electrical and electronic equipment products will be CE marked as required by Directive 2011/65/EU. Components may not be CE marked. Additionally, the part numbers that TE has identified as EU ELV compliant have a maximum concentration of 0.1% by weight in homogenous materials for lead, hexavalent chromium, and mercury, and 0.01% for cadmium, or qualify for an exemption to these limits as defined in the Annexes of Directive 2000/53/EC (ELV). Regarding the REACH Regulation, the information TE provides on SVHC in articles for this part number is based on the latest European Chemicals Agency (ECHA) 'Guidance on requirements for substances in articles' posted at this URL: <https://echa.europa.eu/guidance-documents/guidance-on-reach>

Compatible Parts





TE Part # 770074-1
03P .093 COMM P&S PLUG HSG



TE Part # 770063-1
01P .093 COMM P&S RECPT HSG



TE Part # 770065-1
02P .093 COMM P&S RECPT .248CL



TE Part # 770090-1
06P .093 COMM P&S PLUG HSG

Also in the Series | Commercial Pin and Socket Connectors

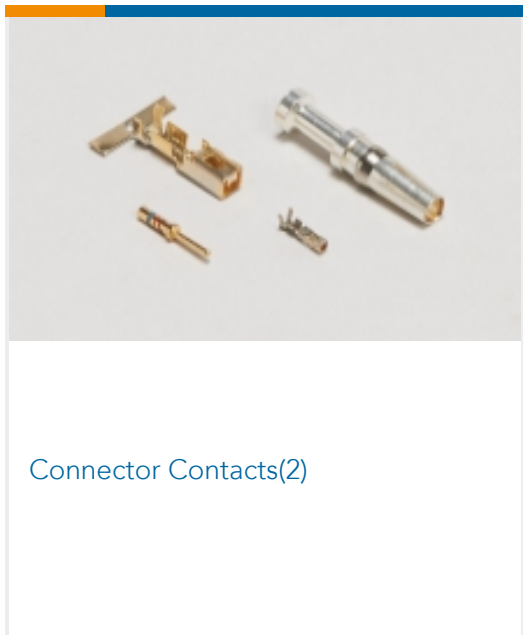

Connector Contacts(2)



Crimp Wire Pins, Tabs & Ferrules(1)

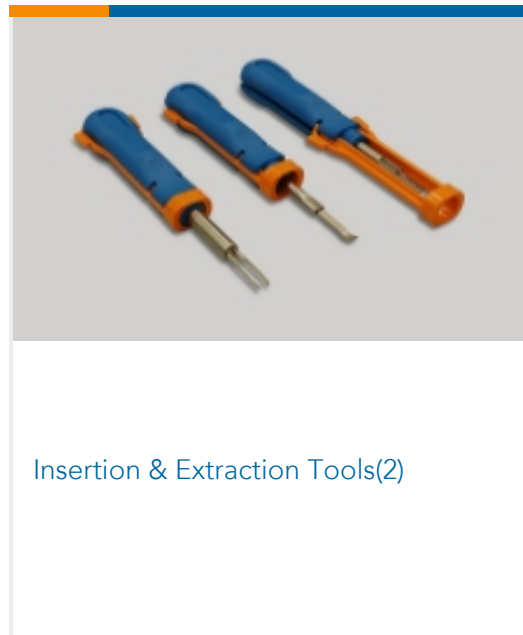

Insertion & Extraction Tools(2)

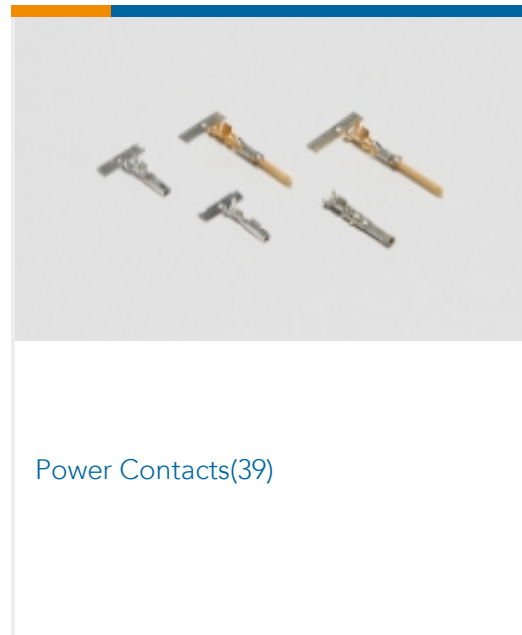

Power Contacts(39)

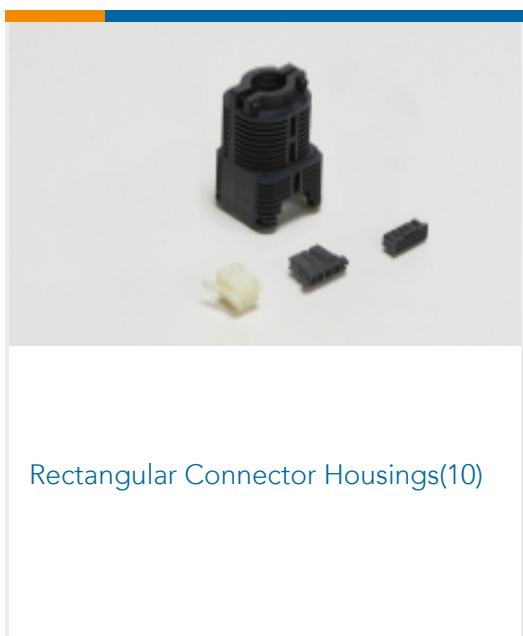

Rectangular Connector Housings(10)



Rectangular Power Connectors(84)

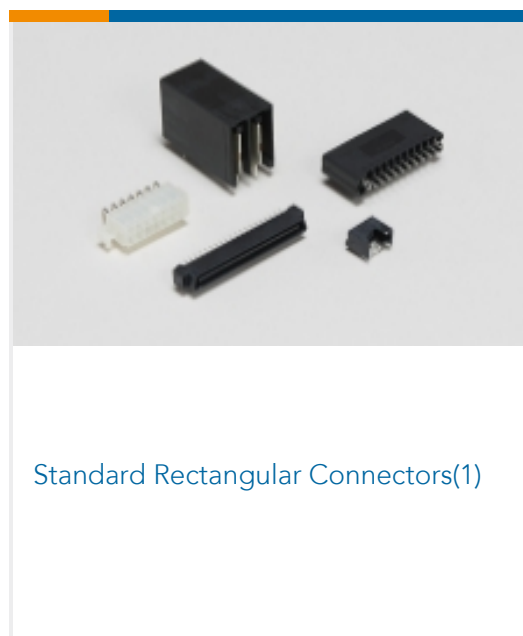

Standard Rectangular Connectors(1)

Customers Also Bought



TE Part #321233
TERMINAL,PIDG SPD 16-14 8



TE Part #1377173-4
SMP 0-0034160-0



TE Part #40725
RING 190(4.82MM)TERMINAL 18-14 AWG TPBR



TE Part #61794-4
RING 18-14 AWG BR



TE Part #770266-1
02P .093 COMM P&S RECPT .248CL



TE Part #770843-1
04P .093 COMM P&S RECPT

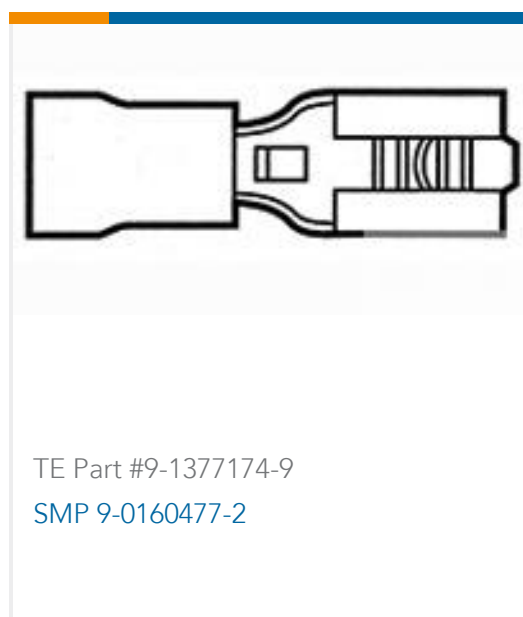

TE Part #9-1377174-9
SMP 9-0160477-2



TE Part #61624-3
RING TERM 12-16 BR W/PAPER

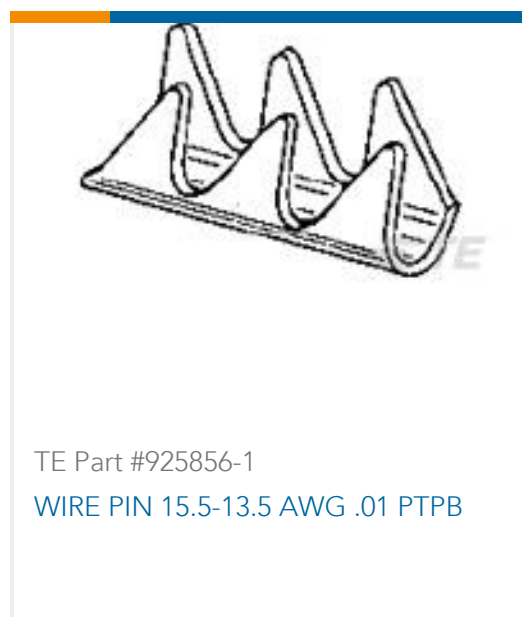

Documents

Product Drawings

[.093 CP&S SOK PTPBR LP 24-18](#)

English

CAD Files

3D PDF

3D

Customer View Model

[ENG_CVM_CVM_770146-1_D.2d_dxf.zip](#)

English

Customer View Model

[ENG_CVM_CVM_770146-1_D.3d_igs.zip](#)

English

Customer View Model

[ENG_CVM_CVM_770146-1_D.3d_stp.zip](#)

English

3D PDF

English

Customer View Model

[ENG_CVM_770146-1_G.3d_igs.zip](#)

English

Customer View Model

[ENG_CVM_770146-1_G.3d_stp.zip](#)

English

Customer View Model

[ENG_CVM_770146-1_G.2d_dxf.zip](#)

English

By downloading the CAD file I accept and agree to the [Terms and Conditions](#) of use.

Datasheets & Catalog Pages

[SOFT_SHELL_PIN_SOCKET_CONNECTORS_STANDARD_DENSITY](#)

English

Product Specifications

[Application Specification](#)

English

