

770031-1 ✓ ACTIVE

MATE-N-LOK | Universal MATE-N-LOK

TE Internal #: 770031-1

Rectangular Power Connectors, Housing, Plug, Wire-to-Wire, 2
Position, 6.35 mm [.25 in] Centerline, Wire & Cable, UL 94V-0,
Universal MATE-N-LOK

[View on TE.com >](#)



Connectors > Power Connectors > Rectangular Power > Rectangular Power Connectors



Rectangular Power Connector Type: **Housing**

Connector & Housing Type: **Plug**

Connector System: **Wire-to-Wire**

Number of Positions: **2**

Centerline (Pitch): **6.35 mm [.25 in]**

Features

Product Type Features

Rectangular Power Connector Type	Housing
Connector & Housing Type	Plug
Connector System	Wire-to-Wire
Sealable	No
Connector & Contact Terminates To	Wire & Cable

Configuration Features

Number of Positions	2
Number of Rows	1

Electrical Characteristics

Operating Voltage	600 VAC
-------------------	---------

Contact Features

Multiple Contact Types	Without
Contact Layout	Inline
Contact Retention Within Housing	Without



Contact Type	Socket
--------------	--------

Termination Features

Termination Method to Wire & Cable	Crimp
------------------------------------	-------

Mechanical Attachment

Connector Mounting Type	Cable Mount (Free-Hanging)
-------------------------	----------------------------

Housing Features

Centerline (Pitch)	6.35 mm [.25 in]
--------------------	------------------

Housing Color	Natural
---------------	---------

Housing Material	Nylon GF
------------------	----------

Dimensions

	.55 in
--	--------

Usage Conditions

Operating Temperature Range	-55 – 120 °C [-67 – 248 °F]
-----------------------------	-----------------------------

Operation/Application

Circuit Application	Power & Signal
---------------------	----------------

Industry Standards

CSA Rating	Certified, LR 7189
------------	--------------------

UL Rating	Recognized
-----------	------------

Agency/Standard	CSA, UL, VDE
-----------------	--------------

Approved Standards	UL E28476
--------------------	-----------

UL Flammability Rating	UL 94V-0
------------------------	----------

Glow Wire Rating	Standard Part - Not Glow Wire
------------------	-------------------------------

Packaging Features

Packaging Quantity	1
--------------------	---

Packaging Method	Package
------------------	---------

Product Compliance

[For compliance documentation, visit the product page on TE.com>](#)

EU RoHS Directive 2011/65/EU	Compliant
------------------------------	-----------

EU ELV Directive 2000/53/EC	Compliant
-----------------------------	-----------

China RoHS 2 Directive MIIT Order No 32, 2016	No Restricted Materials Above Threshold
---	---

EU REACH Regulation (EC) No. 1907/2006

Current ECHA Candidate List: JUNE 2023 (235)

Candidate List Declared Against: JUNE 2023 (235)

Does not contain REACH SVHC

Halogen Content

Low Halogen - Br, Cl, F, I < 900 ppm per homogenous material. Also BFR/CFR/PVC Free

Solder Process Capability

Not applicable for solder process capability

Product Compliance Disclaimer

This information is provided based on reasonable inquiry of our suppliers and represents our current actual knowledge based on the information they provided. This information is subject to change. The part numbers that TE has identified as EU RoHS compliant have a maximum concentration of 0.1% by weight in homogenous materials for lead, hexavalent chromium, mercury, PBB, PBDE, DBP, BBP, DEHP, DIBP, and 0.01% for cadmium, or qualify for an exemption to these limits as defined in the Annexes of Directive 2011/65/EU (RoHS2). Finished electrical and electronic equipment products will be CE marked as required by Directive 2011/65/EU. Components may not be CE marked. Additionally, the part numbers that TE has identified as EU ELV compliant have a maximum concentration of 0.1% by weight in homogenous materials for lead, hexavalent chromium, and mercury, and 0.01% for cadmium, or qualify for an exemption to these limits as defined in the Annexes of Directive 2000/53/EC (ELV). Regarding the REACH Regulation, the information TE provides on SVHC in articles for this part number is based on the latest European Chemicals Agency (ECHA) 'Guidance on requirements for substances in articles' posted at this URL: <https://echa.europa.eu/guidance-documents/guidance-on-reach>

Compatible Parts





Also in the Series | **Universal MATE-N-LOK**

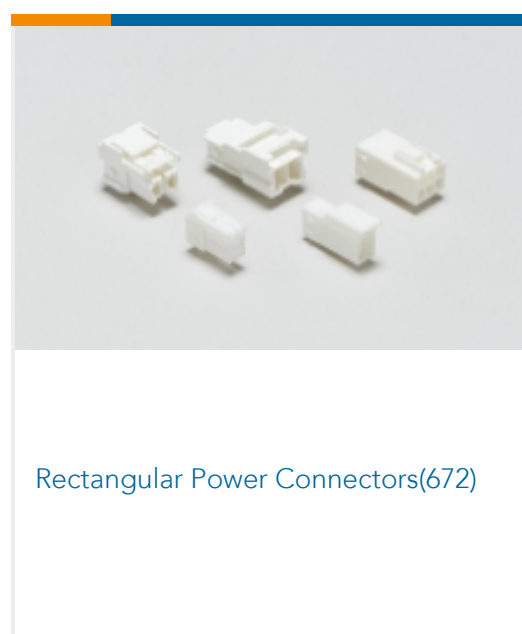
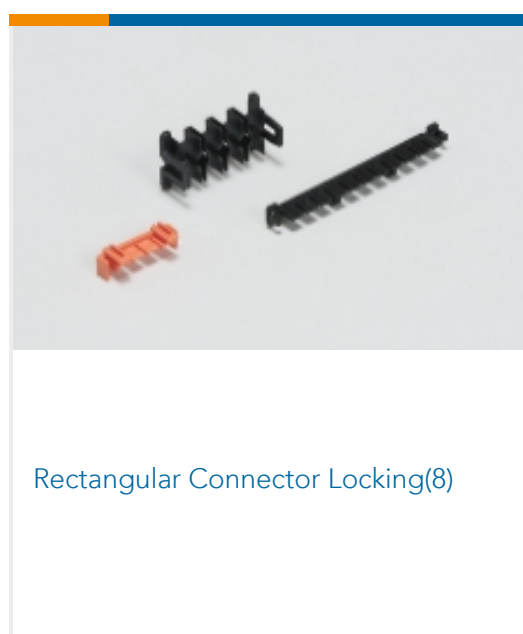
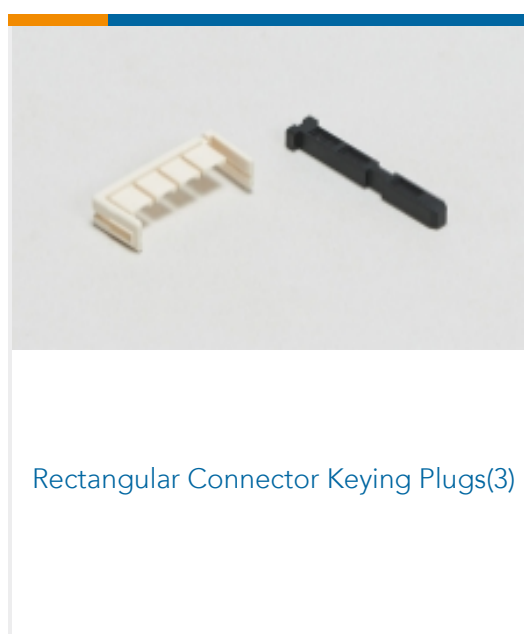
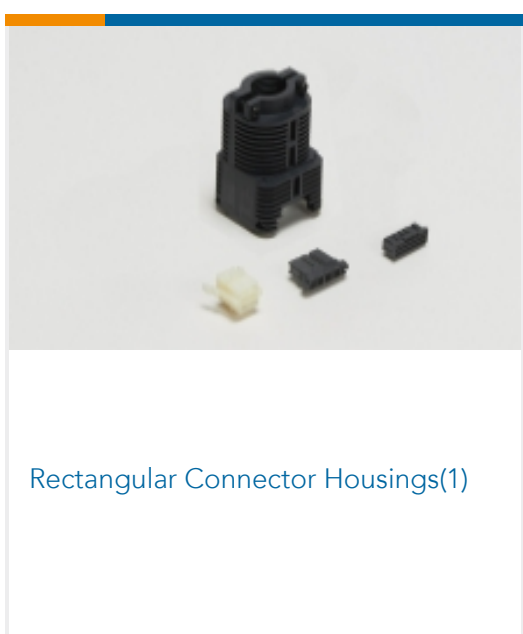
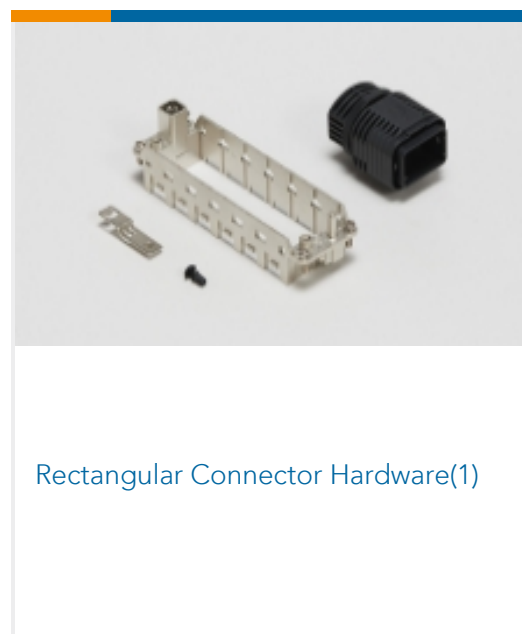
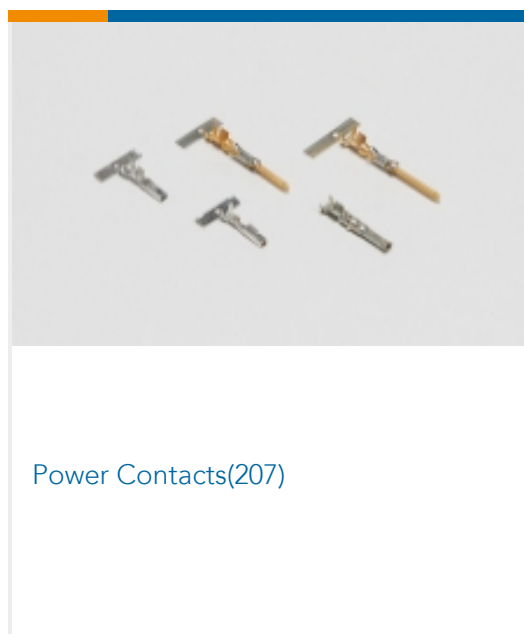
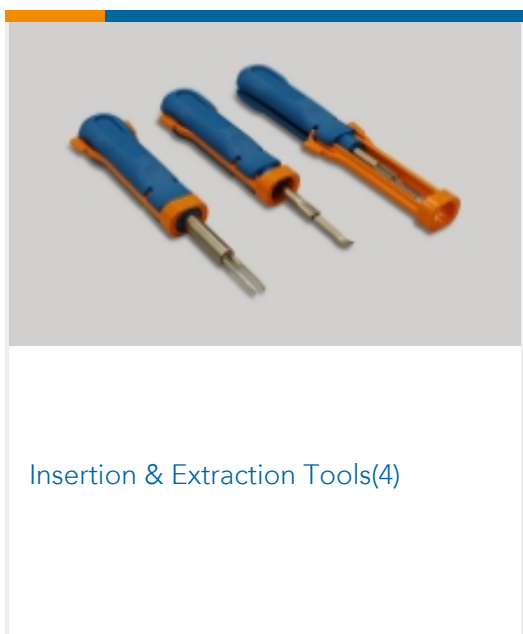
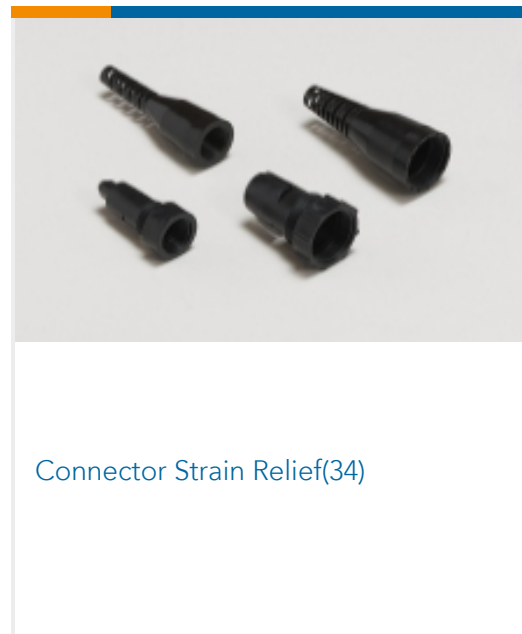
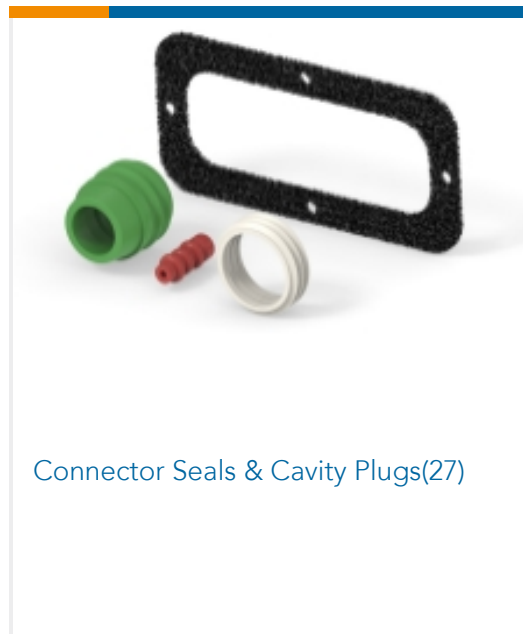
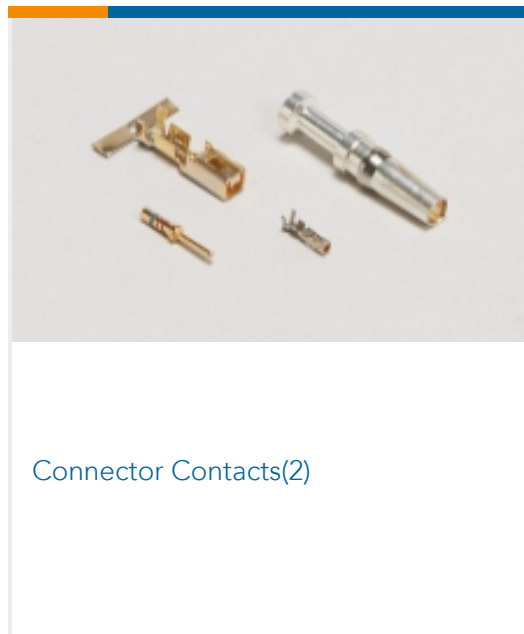
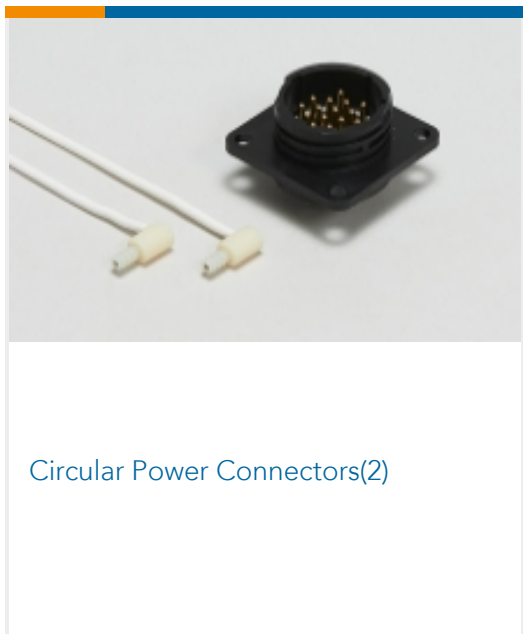

Customers Also Bought

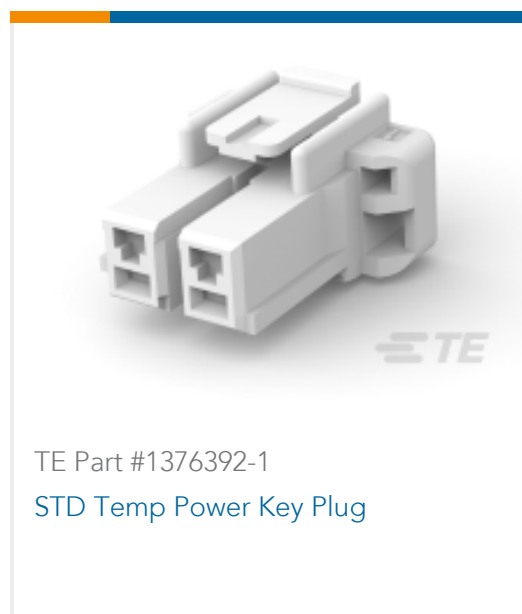

TE Part #1376392-1
STD Temp Power Key Plug



TE Part #1376396-1
5MM POWER KEY D/L PLATE GREEN



TE Part #6-1676966-7
SMD Power Resistor: 7 Watt, 200-2M Ohm



TE Part #63009-1
250 FASTON FLAG REC 18-14 AWG BR



TE Part #770032-1
02P UMNL II PLUG REAR 94VO



TE Part #520935-3
PL&STANDARD FASTON 250 HOUSING REC BLA

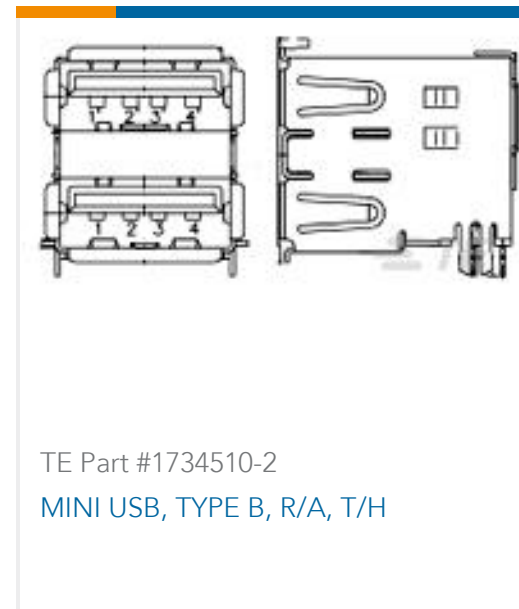

TE Part #1734510-2
MINI USB, TYPE B, R/A, T/H



TE Part #2041517-1
MINI USB, RCPT,V/T,DIP, B TYPE,30u" Au

Documents

Product Drawings

[02P UMNL II PLUG-FRONT 94VO](#)

English

CAD Files

Customer View Model

[ENG_CVM_CVM_770031-1_V.2d_dxf.zip](#)

English

[3D PDF](#)

3D

Customer View Model

[ENG_CVM_CVM_770031-1_V.3d_igs.zip](#)

English

Customer View Model

[ENG_CVM_CVM_770031-1_V.3d_stp.zip](#)

English

By downloading the CAD file I accept and agree to the [Terms and Conditions](#) of use.

Datasheets & Catalog Pages

[SOFT_SHELL_PIN_SOCKET_CONNECTORS_STANDARD_DENSITY](#)

English

Product Specifications

[Application Specification](#)

English

Product Environmental Compliance

[MD_770031-1_11192012518](#)

770031-1

Rectangular Power Connectors, Housing, Plug, Wire-to-Wire, 2 Position, 6.35 mm [.25 in] Centerline, Wire & Cable, UL 94V-0, Universal MATE-N-LOK



English

[MD_770031-1_11192012518](#)

English