

770012-6 ✓ ACTIVE

MATE-N-LOK | Universal MATE-N-LOK

TE Internal #: 770012-6

Power Contacts, Contact, 600 VAC, Gold, 30 – 26 AWG Wire Size, .05 – .13 mm<sup>2</sup> Wire Size, Wire & Cable, Crimp, Power, Socket, Universal MATE-N-LOK

[View on TE.com >](#)



Connectors > Power Connectors > Power Contacts



Power Contact Type: **Contact**

Operating Voltage: **600 VAC**

Contact Mating Area Plating Material: **Gold**

Wire Size: **.05 – .13 mm<sup>2</sup>**

## Features

### Product Type Features

Compatible With Discrete Wire Type	Stranded
Power Contact Type	Contact
Connector & Contact Terminates To	Wire & Cable

### Electrical Characteristics

Operating Voltage	600 VAC
-------------------	---------

### Contact Features

Contact Mating Area Plating Material	Gold
Contact Current Rating (Max)	7 A
Contact Type	Socket
Contact Retention Within Housing	Without
Mating Pin Diameter	2.2 mm[.086 in]
Contact Base Material	Phosphor Bronze
Contact Mating Area Plating Material Thickness	.76 µm[30 µin]
Wire Contact Termination Area Plating Thickness	.76 µm[30 µin]
Wire Contact Termination Area Plating Material	Gold



Wire Contact Termination Area Plating Material Finish	Bright
Contact Orientation	Straight
Contact Underplating Material	Nickel
Contact Underplating Material Thickness	1.27 µm[50 µin]

### Termination Features

Termination Method to Wire & Cable	Crimp
------------------------------------	-------

### Dimensions

Wire Size	.05 – .13 mm <sup>2</sup>
Compatible Insulation Diameter Range	.81 – 1.45 mm[.032 – .057 in]

### Usage Conditions

Operating Temperature Range	-55 – 120 °C[-67 – 248 °F]
-----------------------------	----------------------------

### Operation/Application

Circuit Application	Power
---------------------	-------

### Industry Standards

CSA Rating	Certified, LR 7189
UL Rating	Recognized
Agency/Standard	CSA, UL, VDE

### Packaging Features

Packaging Quantity	5000
Packaging Method	Reel

### Product Compliance

[For compliance documentation, visit the product page on TE.com>](#)

EU RoHS Directive 2011/65/EU	Compliant
EU ELV Directive 2000/53/EC	Compliant
China RoHS 2 Directive MIIT Order No 32, 2016	No Restricted Materials Above Threshold
EU REACH Regulation (EC) No. 1907/2006	Current ECHA Candidate List: JUNE 2023 (235) Candidate List Declared Against: JUNE 2023 (235) Does not contain REACH SVHC
Halogen Content	Low Halogen - Br, Cl, F, I < 900 ppm per homogenous material. Also BFR/CFR/PVC Free

Solder Process Capability

Not applicable for solder process capability

Product Compliance Disclaimer

This information is provided based on reasonable inquiry of our suppliers and represents our current actual knowledge based on the information they provided. This information is subject to change. The part numbers that TE has identified as EU RoHS compliant have a maximum concentration of 0.1% by weight in homogenous materials for lead, hexavalent chromium, mercury, PBB, PBDE, DBP, BBP, DEHP, DIBP, and 0.01% for cadmium, or qualify for an exemption to these limits as defined in the Annexes of Directive 2011/65/EU (RoHS2). Finished electrical and electronic equipment products will be CE marked as required by Directive 2011/65/EU. Components may not be CE marked. Additionally, the part numbers that TE has identified as EU ELV compliant have a maximum concentration of 0.1% by weight in homogenous materials for lead, hexavalent chromium, and mercury, and 0.01% for cadmium, or qualify for an exemption to these limits as defined in the Annexes of Directive 2000/53/EC (ELV). Regarding the REACH Regulation, the information TE provides on SVHC in articles for this part number is based on the latest European Chemicals Agency (ECHA) 'Guidance on requirements for substances in articles' posted at this URL: <https://echa.europa.eu/guidance-documents/guidance-on-reach>

### Compatible Parts



TE Part # 539972-1  
EXTRACTION TOOL



TE Part # 455830-1  
INSERTION TOOL



TE Part # 770022-1  
12P UMNLII IN-LINE PLUG HSG KIT



TE Part # 770019-1  
04P UMNLII IN-LINE PLUG HSG KIT



TE Part # 770028-1  
09P UMNLII IN-LINE CAP HSG KIT



TE Part # 770026-1  
04P UMNLII IN-LINE CAP HSG KIT



TE Part # 770024-1  
02P UMNLII IN-LINE CAP HSG KIT



TE Part # 770029-1  
12P UMNLII IN-LINE CAP HSG KIT



TE Part # 770021-1  
09P UMNLII IN-LINE PLUG HSG KIT



TE Part # 770030-1  
15P UMNLII IN-LINE CAP HSG KIT



TE Part # 770018-1  
03P UMNLII IN-LINE PLUG HSG KIT



TE Part # 770027-1  
06P UMNLII IN-LINE CAP HSG KIT



## Also in the Series | Universal MATE-N-LOK

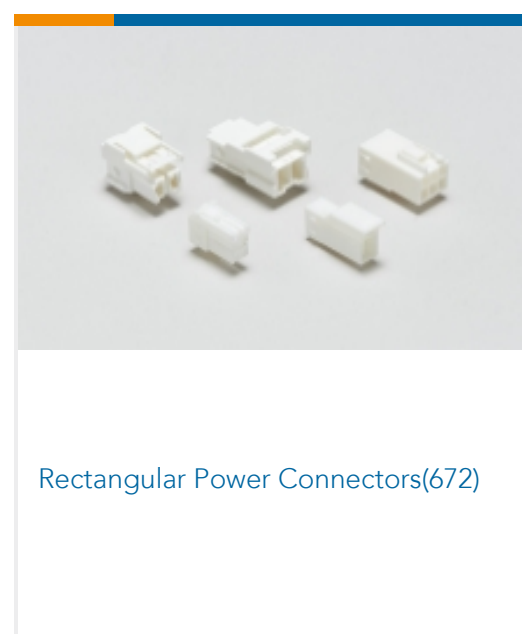
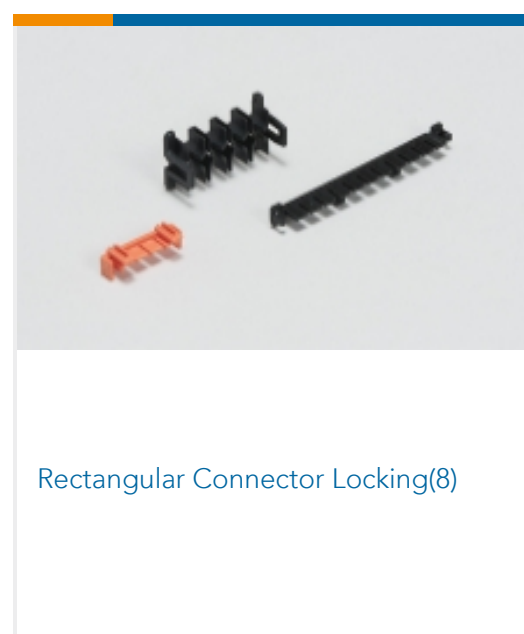
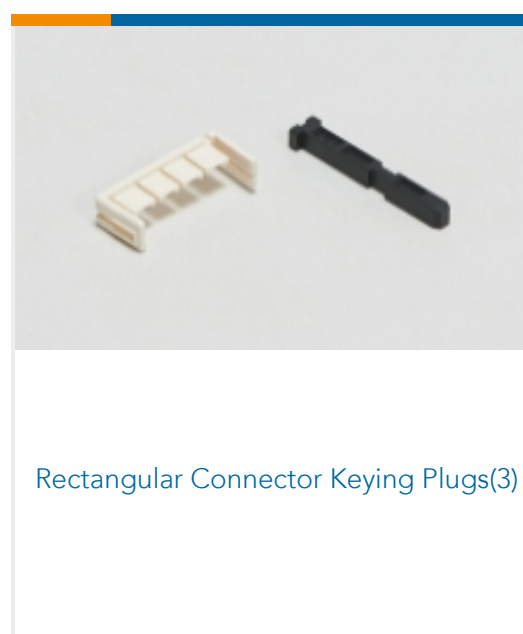
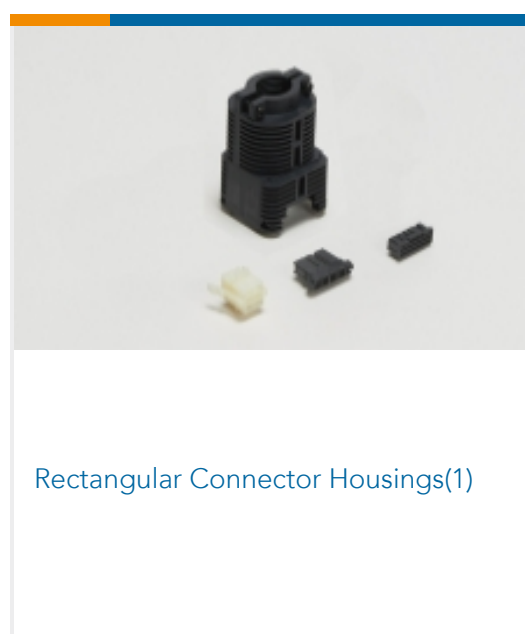
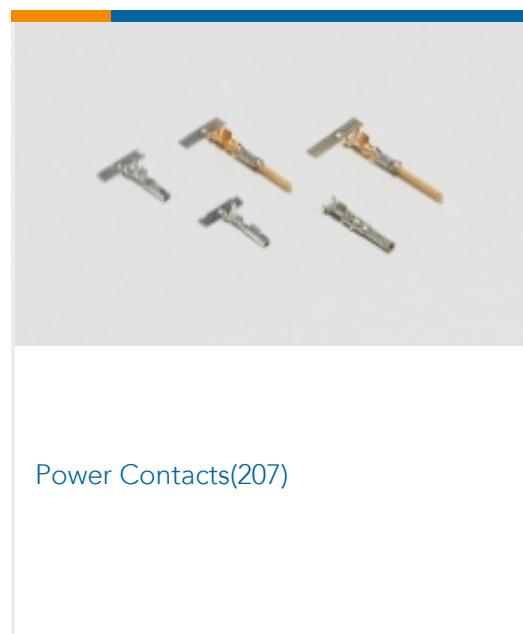
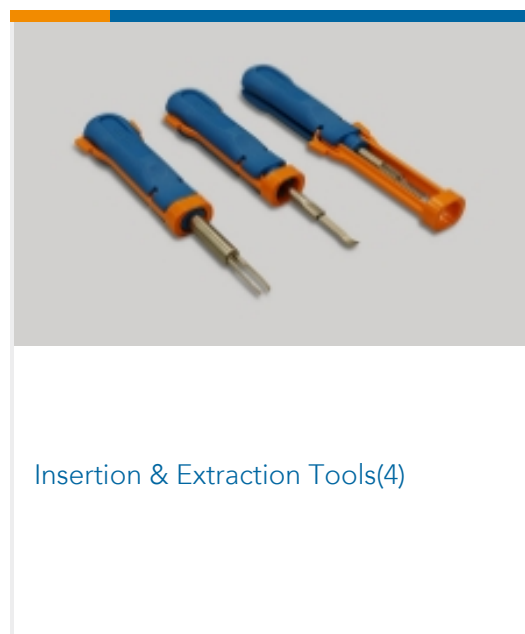
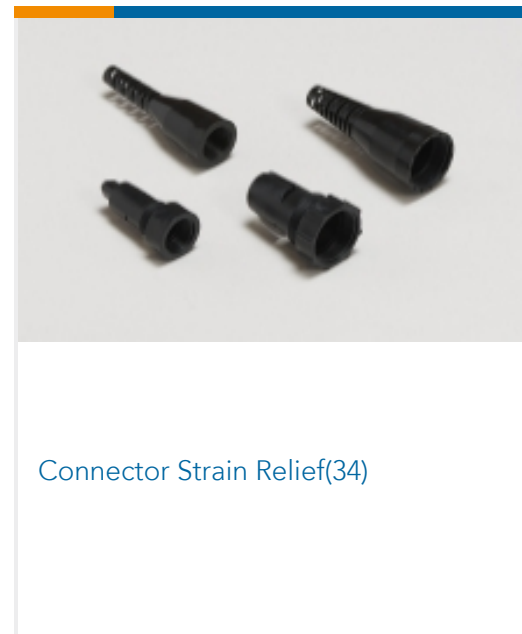
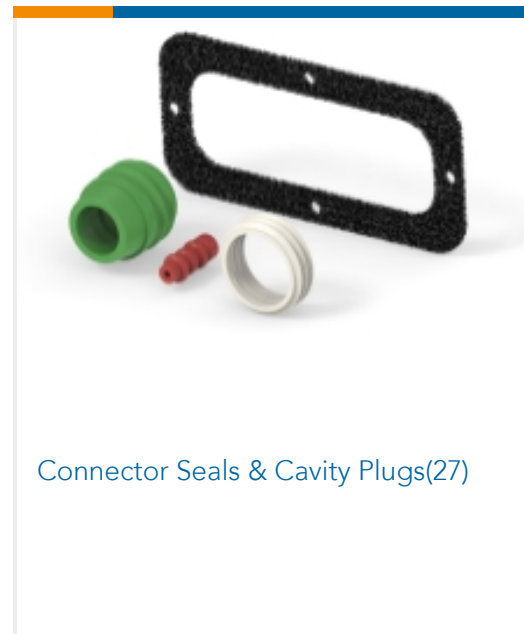
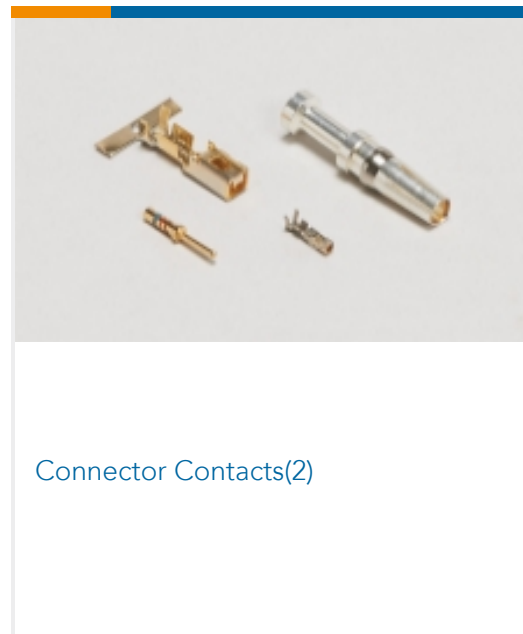
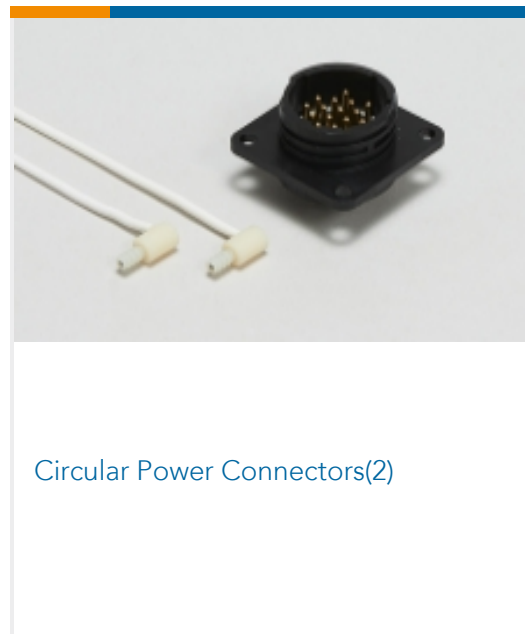

## Customers Also Bought



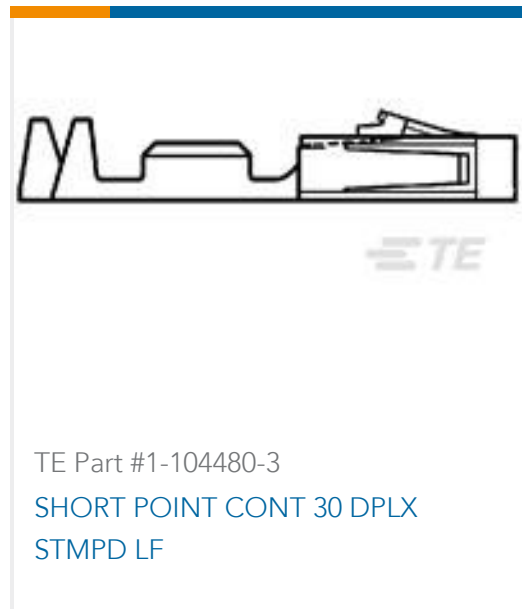

## Documents

### Product Drawings

[UMNL II SOK SELECT AU/PHBZ](#)

English

### CAD Files

[3D PDF](#)

3D

Customer View Model

[ENG\\_CVM\\_CVM\\_770012-6\\_G.2d\\_dxf.zip](#)

English

Customer View Model

[ENG\\_CVM\\_CVM\\_770012-6\\_G.3d\\_igs.zip](#)

English

Customer View Model

[ENG\\_CVM\\_CVM\\_770012-6\\_G.3d\\_stp.zip](#)

English

[3D PDF](#)

English



**Customer View Model**

[ENG\\_CVM\\_770012-6\\_C.3d\\_igs.zip](#)

English

**Customer View Model**

[ENG\\_CVM\\_770012-6\\_C.3d\\_stp.zip](#)

English

**Customer View Model**

[ENG\\_CVM\\_770012-6\\_C.2d\\_dxf.zip](#)

English

By downloading the CAD file I accept and agree to the [Terms and Conditions](#) of use.

---

**Datasheets & Catalog Pages**

[SOFT\\_SHELL\\_PIN\\_SOCKET\\_CONNECTORS\\_STANDARD\\_DENSITY](#)

English

---

**Product Specifications**

[Application Specification](#)

English