

770007-1 ✓ ACTIVE

MATE-N-LOK | Universal MATE-N-LOK

TE Internal #: 770007-1

Power Contacts, Contact, 600 VAC, Tin, 20 – 14 AWG Wire Size, .5 – 2 mm² Wire Size, Wire & Cable, Crimp, Power, Pin, Universal MATE-N-LOK

[View on TE.com >](#)



Connectors > Power Connectors > Power Contacts

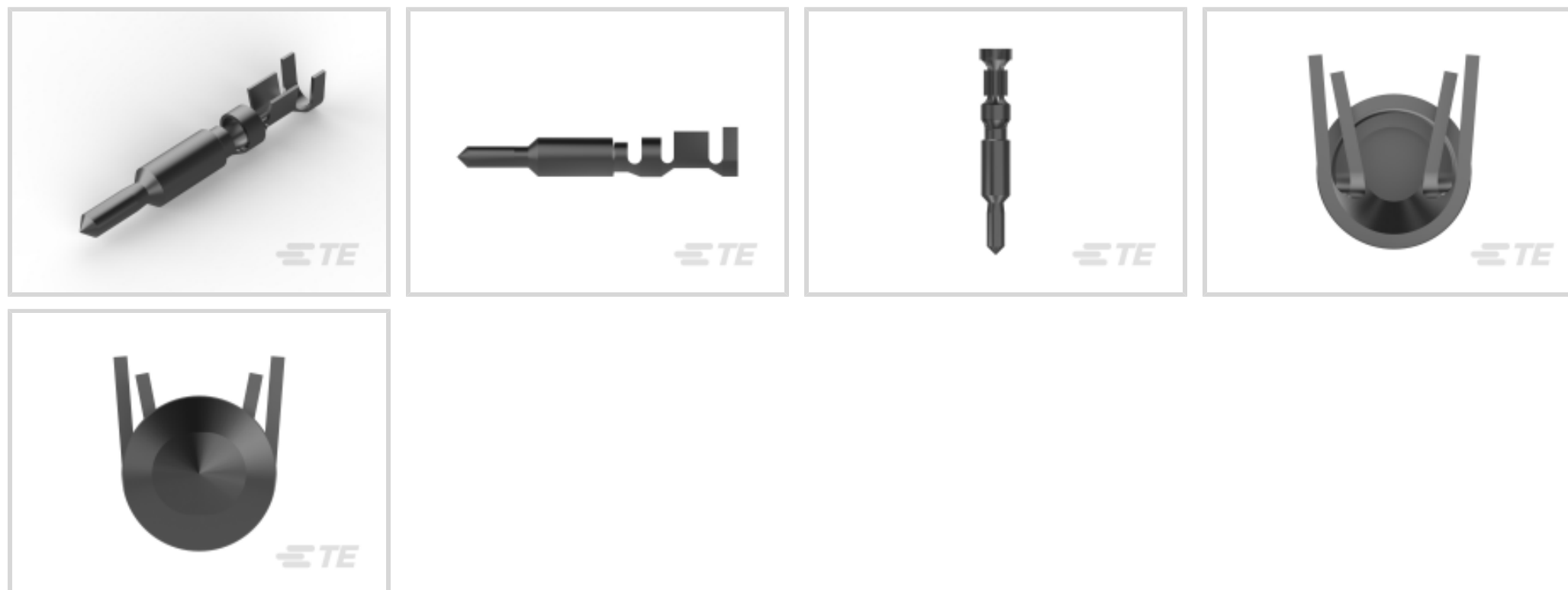

Power Contact Type: **Contact**

Operating Voltage: **600 VAC**

Contact Mating Area Plating Material: **Tin**

Wire Size: **.5 – 2 mm²**

Features

Product Type Features

Compatible With Discrete Wire Type	Stranded
Power Contact Type	Contact
Connector & Contact Terminates To	Wire & Cable

Electrical Characteristics

Operating Voltage	600 VAC
-------------------	---------

Contact Features

Contact Mating Area Plating Material	Tin
Contact Current Rating (Max)	7 A
Contact Type	Pin
Contact Retention Within Housing	Without
Mating Pin Diameter	2.18 mm [.086 in]
Contact Base Material	Brass
Wire Contact Termination Area Plating Material	Pre-Tin
Wire Contact Termination Area Plating Material Finish	Matte
Contact Orientation	Straight



Termination Features

Termination Method to Wire & Cable	Crimp
------------------------------------	-------

Mechanical Attachment

Wire Insulation Support	Without
-------------------------	---------

Dimensions

Wire Size	.5 – 2 mm ²
Compatible Insulation Diameter Range	1.52 – 3.3 mm [.06 – .13 in]

Usage Conditions

Operating Temperature Range	-55 – 120 °C [-67 – 248 °F]
-----------------------------	-----------------------------

Operation/Application

Circuit Application	Power
---------------------	-------

Industry Standards

CSA Rating	Certified, LR 7189
UL Rating	Recognized
Agency/Standard	CSA, UL, VDE

Packaging Features

Packaging Quantity	4000
Packaging Method	Reel

Product Compliance

[For compliance documentation, visit the product page on TE.com>](#)

EU RoHS Directive 2011/65/EU	Compliant
EU ELV Directive 2000/53/EC	Compliant
China RoHS 2 Directive MIIT Order No 32, 2016	No Restricted Materials Above Threshold
EU REACH Regulation (EC) No. 1907/2006	Current ECHA Candidate List: JUNE 2023 (235) Candidate List Declared Against: JUNE 2023 (235) Does not contain REACH SVHC
Halogen Content	Low Halogen - Br, Cl, F, I < 900 ppm per homogenous material. Also BFR/CFR/PVC Free
Solder Process Capability	Not applicable for solder process capability

Product Compliance Disclaimer

This information is provided based on reasonable inquiry of our suppliers and represents our current actual knowledge based on the information they provided. This information is subject to change. The part numbers that TE has identified as EU RoHS compliant have a maximum concentration of 0.1% by weight in homogenous materials for lead, hexavalent chromium, mercury, PBB, PBDE, DBP, BBP, DEHP, DIBP, and 0.01% for cadmium, or qualify for an exemption to these limits as defined in the Annexes of Directive 2011/65/EU (RoHS2). Finished electrical and electronic equipment products will be CE marked as required by Directive 2011/65/EU. Components may not be CE marked. Additionally, the part numbers that TE has identified as EU ELV compliant have a maximum concentration of 0.1% by weight in homogenous materials for lead, hexavalent chromium, and mercury, and 0.01% for cadmium, or qualify for an exemption to these limits as defined in the Annexes of Directive 2000/53/EC (ELV). Regarding the REACH Regulation, the information TE provides on SVHC in articles for this part number is based on the latest European Chemicals Agency (ECHA) 'Guidance on requirements for substances in articles' posted at this URL: <https://echa.europa.eu/guidance-documents/guidance-on-reach>

Compatible Parts

 <p>TE Part # 90546-1 ASSY PRO-CRIMPER UNIV M-N-L</p>	 <p>TE Part # 91500-1 CCII UNML UNML II PIN SKT 20-14 ASSY</p>	 <p>TE Part # 90546-2 PROCRIMPER DIE ASSY UNIV MNL</p>	 <p>TE Part # 770022-1 12P UMNLI IN-LNE PLUG HSG KIT</p>
 <p>TE Part # 770019-1 04P UMNLI IN-LNE PLUG HSG KIT</p>	 <p>TE Part # 770028-1 09P UMNLI IN-LINE CAP HSG KIT</p>	 <p>TE Part # 770026-1 04P UMNLI IN-LINE CAP HSG KIT</p>	 <p>TE Part # 770024-1 02P UMNLI IN-LINE CAP HSG KIT</p>
 <p>TE Part # 770029-1 12P UMNLI IN-LINE CAP HSG KIT</p>	 <p>TE Part # 770021-1 09P UMNLI IN-LNE PLUG HSG KIT</p>	 <p>TE Part # 770030-1 15P UMNLI IN-LINE CAP HSG KIT</p>	 <p>TE Part # 770018-1 03P UMNLI IN-LNE PLUG HSG KIT</p>
 <p>TE Part # 770027-1 06P UMNLI IN-LINE CAP HSG KIT</p>	 <p>TE Part # 770025-1 03P UMNLI IN-LINE CAP HSG KIT</p>	 <p>TE Part # 770017-1 02P UMNLI IN-LNE PLUG HSG KIT</p>	 <p>TE Part # 770020-1 06P UMNLI IN-LNE PLUG HSG KIT</p>



Also in the Series | Universal MATE-N-LOK

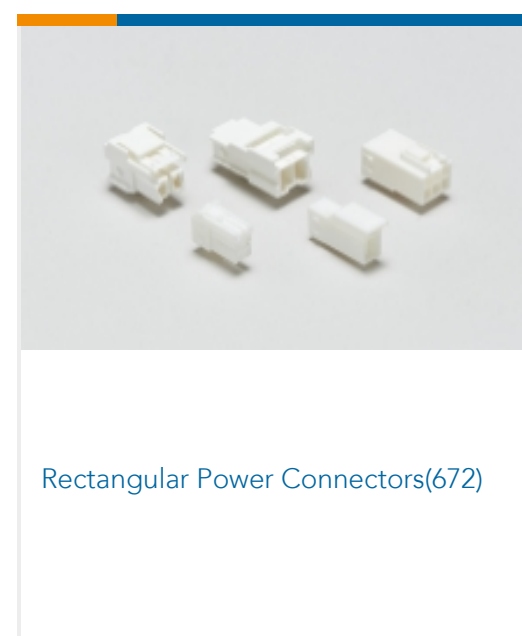
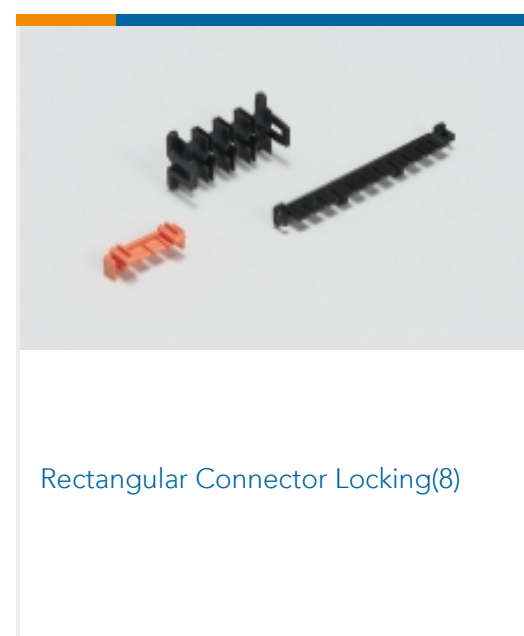
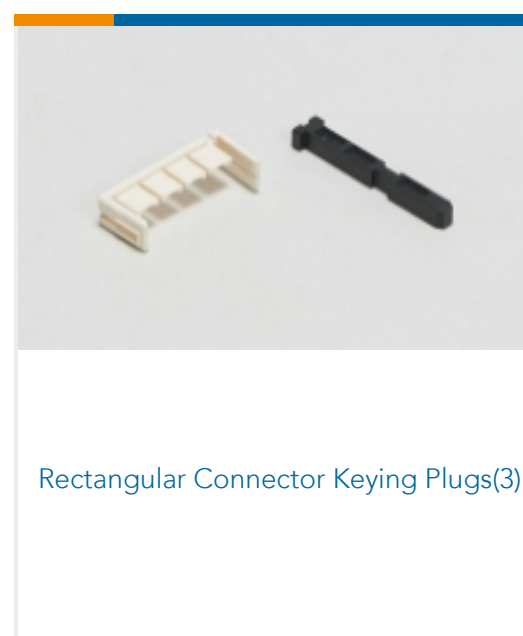
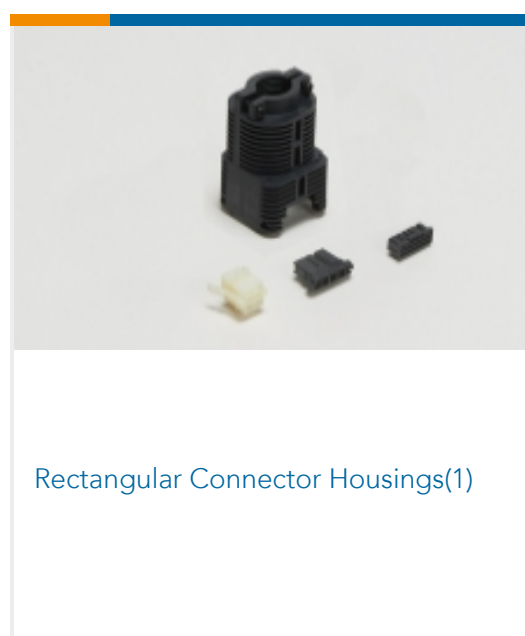
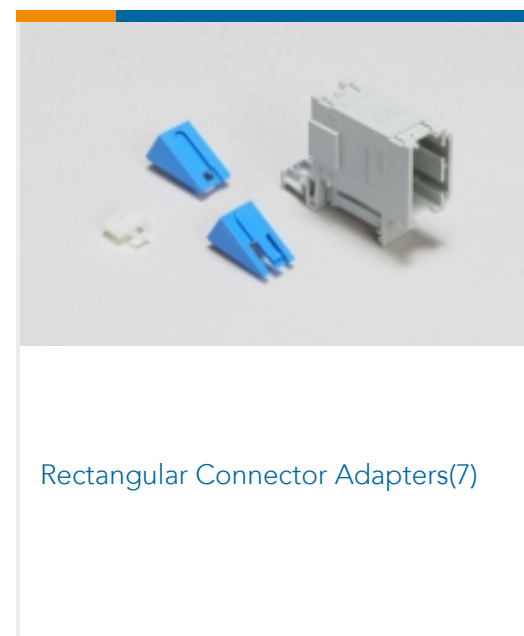
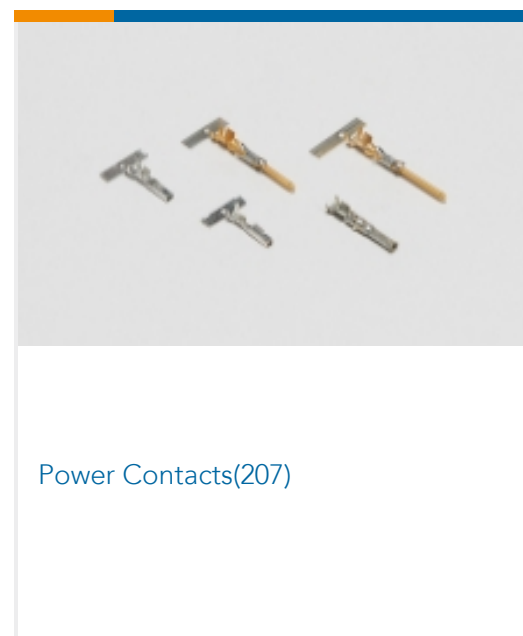
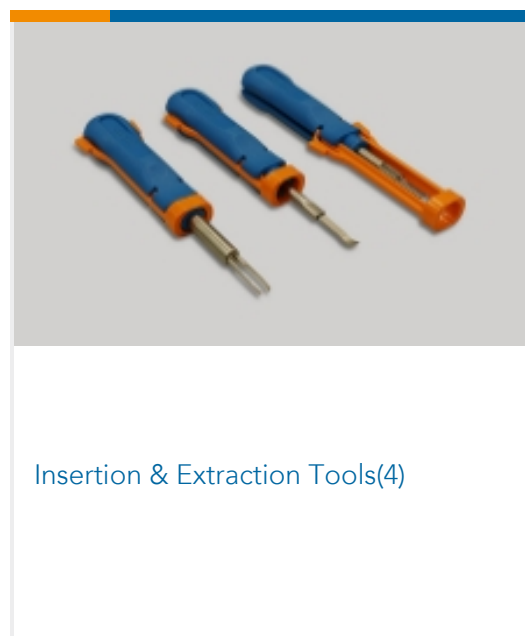
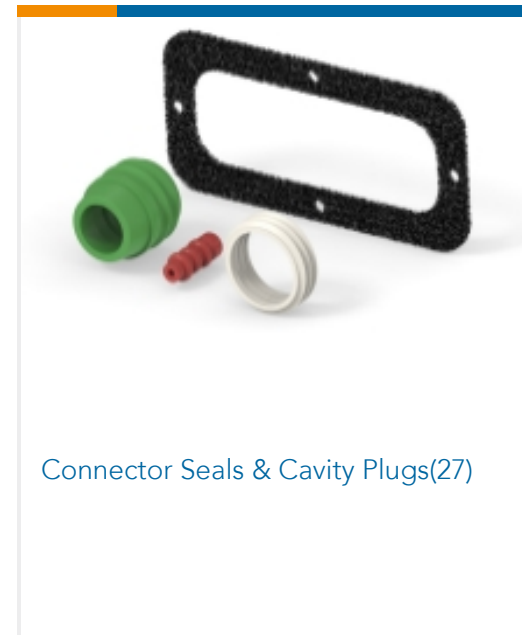
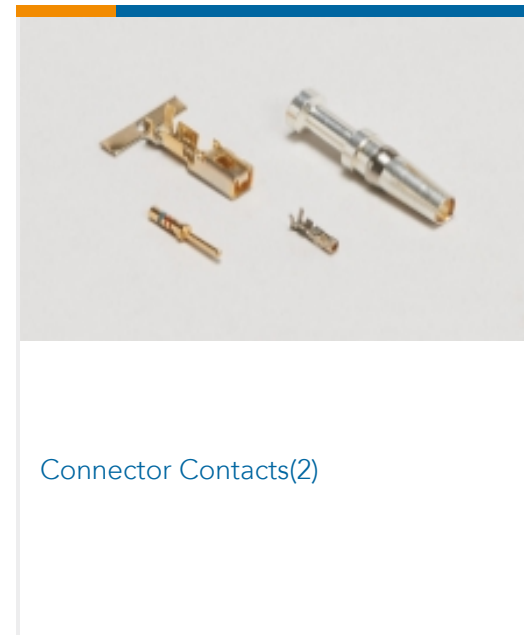
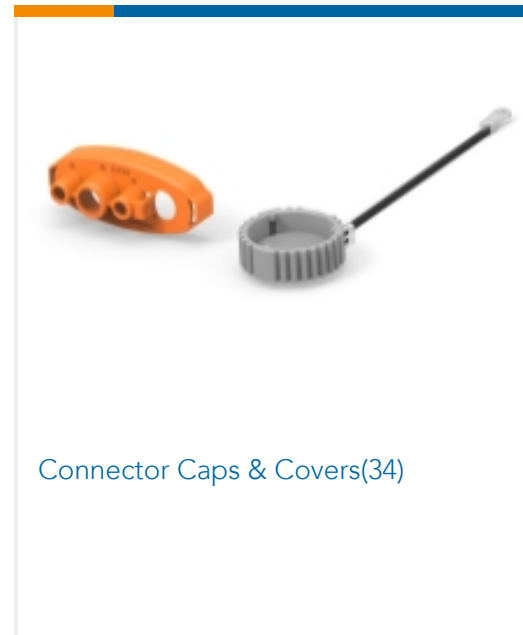
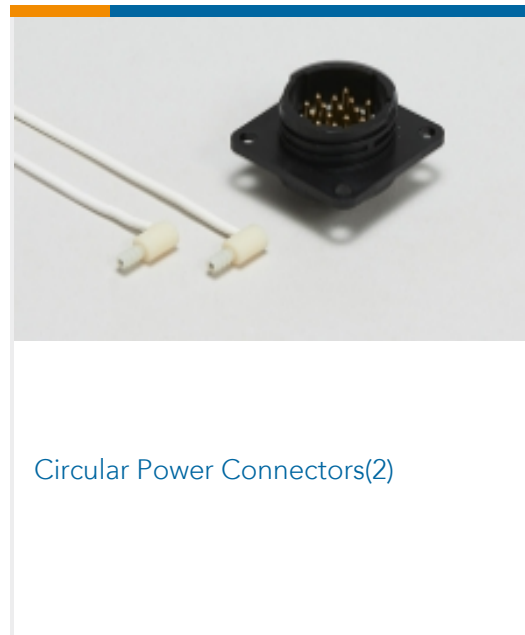

Customers Also Bought

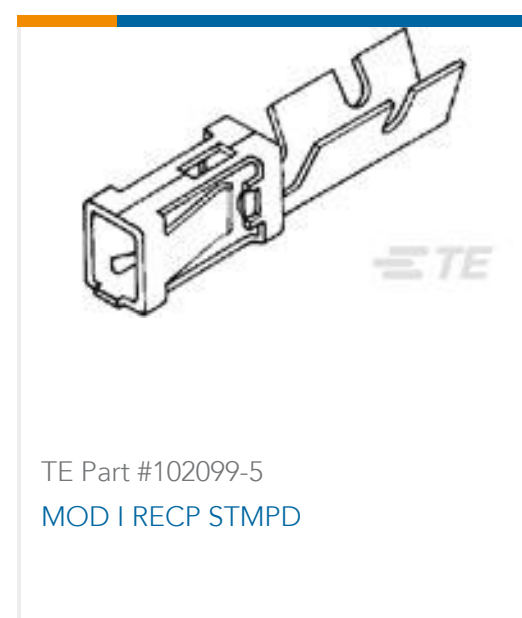



Documents

Product Drawings

UMNL II PIN PTPBR

English

CAD Files

3D PDF

3D

Customer View Model

[ENG_CVM_CVM_770007-1_T.2d_dxf.zip](#)

English

Customer View Model

[ENG_CVM_CVM_770007-1_T.3d_igs.zip](#)

English

Customer View Model

[ENG_CVM_CVM_770007-1_T.3d_stp.zip](#)

English

By downloading the CAD file I accept and agree to the [Terms and Conditions](#) of use.

Datasheets & Catalog Pages

SOFT_SHELL_PIN_SOCKET_CONNECTORS_STANDARD_DENSITY

English

Product Specifications

Application Specification

English

Product Environmental Compliance

MD_770007-1_02262018832_dmtec



English

[MD_770007-1_02262018832_dmtec](#)

English