



Connectors > D-Shaped Connectors > D-Sub Accessories > D-Sub Locking & Mounting



Connector Mounting Accessory Type: **Screw Retainer Clip**

Features

Product Type Features

Connector Mounting Accessory Type	Screw Retainer Clip
-----------------------------------	---------------------

Mechanical Attachment

Thread Size	4-40
-------------	------

Packaging Features

Packaging Quantity	2000
Packaging Method	Bag, Individual

Product Compliance

[For compliance documentation, visit the product page on TE.com>](#)

EU RoHS Directive 2011/65/EU	Compliant
EU ELV Directive 2000/53/EC	Not Yet Reviewed
China RoHS 2 Directive MIIT Order No 32, 2016	No Restricted Materials Above Threshold
EU REACH Regulation (EC) No. 1907/2006	Current ECHA Candidate List: JUNE 2023 (235) Candidate List Declared Against: JUNE 2023 (235) Does not contain REACH SVHC
Halogen Content	Low Halogen - Br, Cl, F, I < 900 ppm per homogenous material. Also BFR/CFR/PVC Free

Solder Process Capability

Not applicable for solder process capability

Product Compliance Disclaimer

This information is provided based on reasonable inquiry of our suppliers and represents our current actual knowledge based on the information they provided. This information is subject to change. The part numbers that TE has identified as EU RoHS compliant have a maximum concentration of 0.1% by weight in homogenous materials for lead, hexavalent chromium, mercury, PBB, PBDE, DBP, BBP, DEHP, DIBP, and 0.01% for cadmium, or qualify for an exemption to these limits as defined in the Annexes of Directive 2011/65/EU (RoHS2). Finished electrical and electronic equipment products will be CE marked as required by Directive 2011/65/EU. Components may not be CE marked. Additionally, the part numbers that TE has identified as EU ELV compliant have a maximum concentration of 0.1% by weight in homogenous materials for lead, hexavalent chromium, and mercury, and 0.01% for cadmium, or qualify for an exemption to these limits as defined in the Annexes of Directive 2000/53/EC (ELV). Regarding the REACH Regulation, the information TE provides on SVHC in articles for this part number is based on the latest European Chemicals Agency (ECHA) 'Guidance on requirements for substances in articles' posted at this URL: <https://echa.europa.eu/guidance-documents/guidance-on-reach>

Compatible Parts

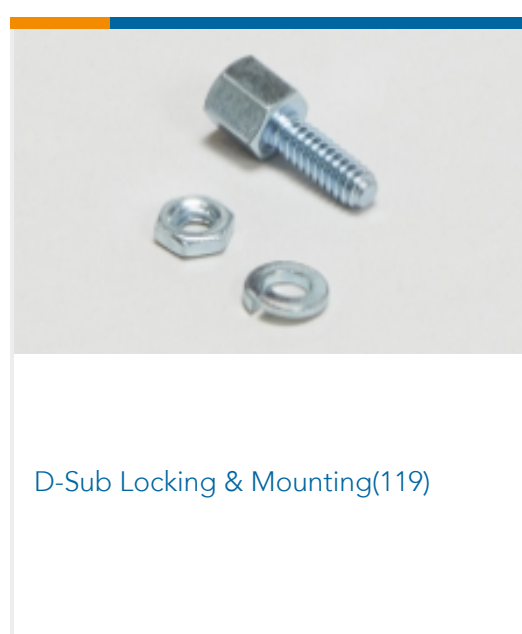
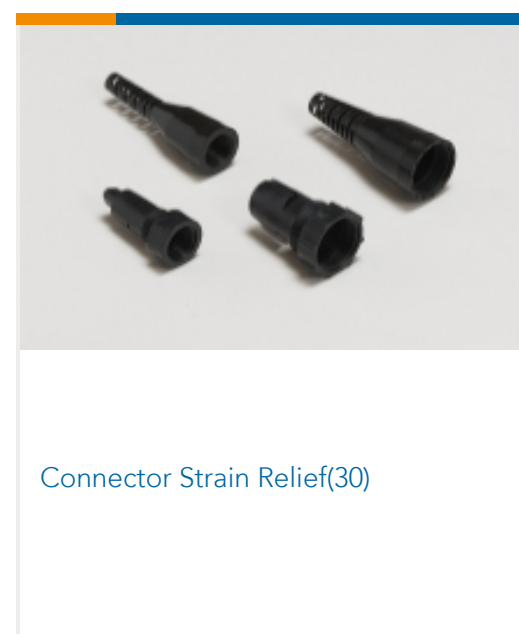
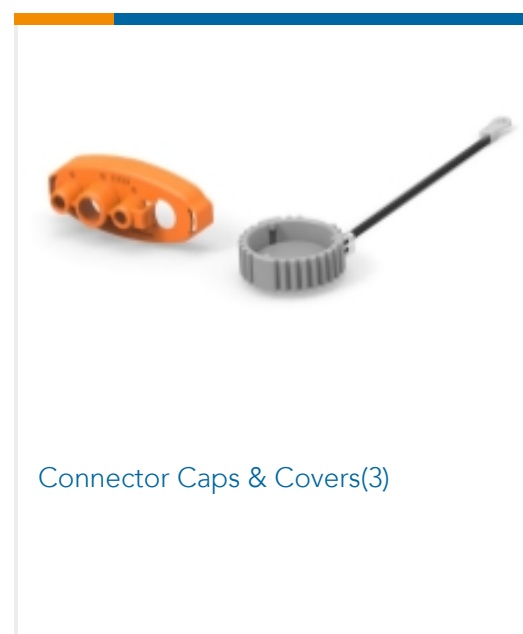
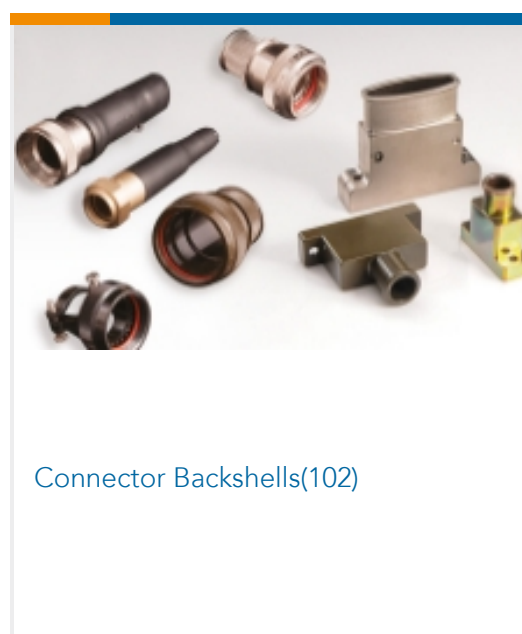
Also in the Series | **AMPLIMITE Kit**

Customers Also Bought



TE Part #5172068-3
Standard Drawer Receptacle Housings



TE Part #1-1462038-7
IM07NS=IM RELAY 200mW 24V



TE Part #34141
PG R 22-16 COMM 22-18 MIL 4

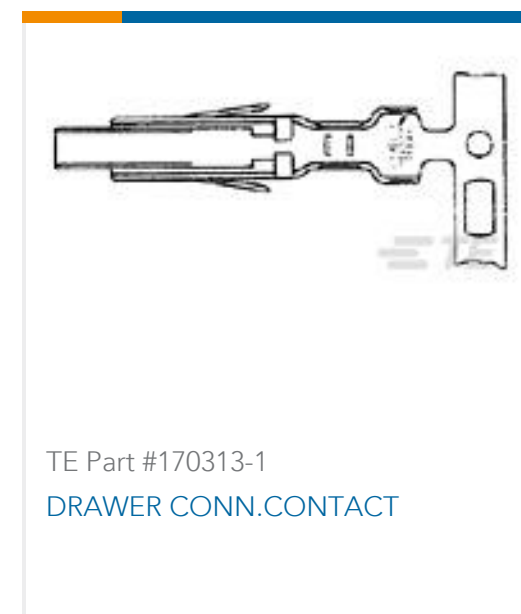

TE Part #170313-1
DRAWER CONN.CONTACT



TE Part #206794-4
PIN CONTACT, SZ 20

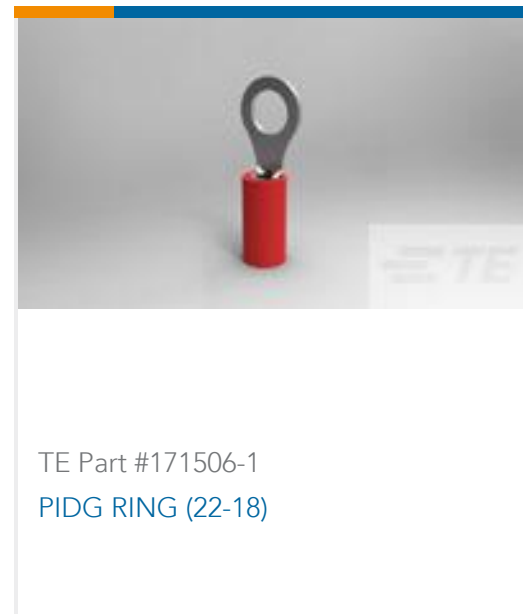

TE Part #171506-1
PIDG RING (22-18)



TE Part #1825002-1
ADF0204=DIP SWT,FLUSH,THRU/HL



TE Part #193842-1
SKT ASSY., 2MM, 12-14 AWG

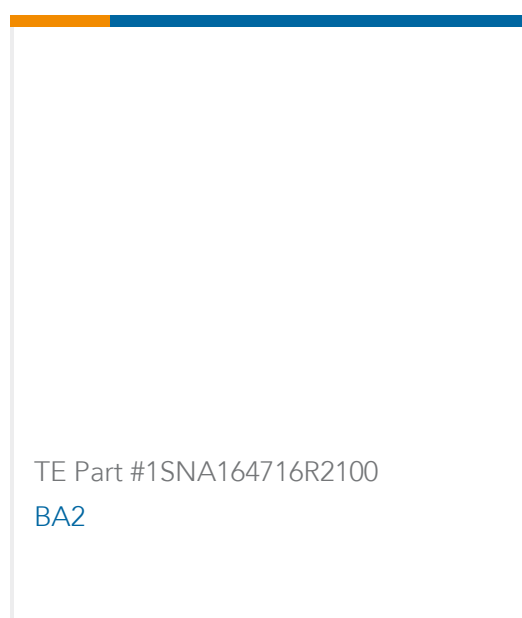

TE Part #1SNA164716R2100
BA2

Documents

Product Drawings

[SCREW RETAINER CLIP,AMPLIMITE](#)

English

CAD Files

[3D PDF](#)

3D

Customer View Model

[ENG_CVM_CVM_748274-2_K.2d_dxf.zip](#)

English

Customer View Model

[ENG_CVM_CVM_748274-2_K.3d_igs.zip](#)

English

Customer View Model

[ENG_CVM_CVM_748274-2_K.3d_stp.zip](#)

English

By downloading the CAD file I accept and agree to the [Terms and Conditions](#) of use.

Product Environmental Compliance



[MD_748274-2_07172017735_dmtec](#)

English

[MD_748274-2_07172017735_dmtec](#)

English