

66394-8 ✓ ACTIVE

AMP | AMP Type III+

TE Internal #: 66394-8

Power Contacts, Contact, Gold, 30 – 26 AWG Wire Size, .05 – .15 mm<sup>2</sup> Wire Size, Wire & Cable, Crimp, Power & Signal, Socket, AMP Type III+

[View on TE.com >](#)



Connectors > Power Connectors > Power Contacts > Strip Pin and Socket Contacts, Type III



Power Contact Type: **Contact**

Contact Mating Area Plating Material: **Gold**

Wire Size: **.05 – .15 mm<sup>2</sup>**

Connector & Contact Terminates To: **Wire & Cable**

[All Strip Pin and Socket Contacts, Type III \(55\)](#)

## Features

### Product Type Features

Compatible With Discrete Wire Type	Stranded
Power Contact Type	Contact
Connector & Contact Terminates To	Wire & Cable

### Contact Features

Contact Size	Size 16
Barrel Type	Open
Contact Mating Area Plating Material	Gold
Contact Current Rating (Max)	13 A
Contact Type	Socket
Contact Retention Within Housing	With
Mating Pin Diameter	1.57 mm[.062 in]
Contact Base Material	Brass
Contact Mating Area Plating Material Thickness	.76 μm[30 μin]



Wire Contact Termination Area Plating Thickness	1.27 μm[50 μin]
---	-----------------

Wire Contact Termination Area Plating Material	Tin
--	-----

Wire Contact Termination Area Plating Material Finish	Matte
---	-------

Contact Orientation	Straight
---------------------	----------

Contact Underplating Material	Nickel
-------------------------------	--------

Contact Underplating Material Thickness	.76 μm[30 μin]
---	----------------

### Termination Features

Termination Method to Wire & Cable	Crimp
------------------------------------	-------

### Mechanical Attachment

Contact Retention Type Within Housing	Locking Lance
---------------------------------------	---------------

Wire Insulation Support	With
-------------------------	------

### Dimensions

Wire Size	.05 – .15 mm <sup>2</sup>
-----------	---------------------------

Compatible Insulation Diameter Range	.36 – .76 mm[.014 – .03 in]
--------------------------------------	-----------------------------

### Usage Conditions

Operating Temperature Range	-55 – 150 °C[-67 – 302 °F]
-----------------------------	----------------------------

### Operation/Application

Circuit Application	Power & Signal
---------------------	----------------

### Industry Standards

Agency/Standard	CSA, IEC, UL
-----------------	--------------

### Packaging Features

Packaging Quantity	4000
--------------------	------

Packaging Method	Reel
------------------	------

### Other

Power Connectors Comment	Overall insulation crimp diameter, including crimp barrel, must not exceed 3.18 [.125].
--------------------------	---

### Product Compliance

[For compliance documentation, visit the product page on TE.com>](#)

EU RoHS Directive 2011/65/EU	Compliant
------------------------------	-----------









EU ELV Directive 2000/53/EC	Compliant
-----------------------------	-----------

China RoHS 2 Directive MIIT Order No 32, 2016	No Restricted Materials Above Threshold
EU REACH Regulation (EC) No. 1907/2006	Current ECHA Candidate List: JUNE 2023 (235) Candidate List Declared Against: JUNE 2023 (235) Does not contain REACH SVHC
Halogen Content	Low Halogen - Br, Cl, F, I < 900 ppm per homogenous material. Also BFR/CFR/PVC Free
Solder Process Capability	Not applicable for solder process capability

Product Compliance Disclaimer

This information is provided based on reasonable inquiry of our suppliers and represents our current actual knowledge based on the information they provided. This information is subject to change. The part numbers that TE has identified as EU RoHS compliant have a maximum concentration of 0.1% by weight in homogenous materials for lead, hexavalent chromium, mercury, PBB, PBDE, DBP, BBP, DEHP, DIBP, and 0.01% for cadmium, or qualify for an exemption to these limits as defined in the Annexes of Directive 2011/65/EU (RoHS2). Finished electrical and electronic equipment products will be CE marked as required by Directive 2011/65/EU. Components may not be CE marked. Additionally, the part numbers that TE has identified as EU ELV compliant have a maximum concentration of 0.1% by weight in homogenous materials for lead, hexavalent chromium, and mercury, and 0.01% for cadmium, or qualify for an exemption to these limits as defined in the Annexes of Directive 2000/53/EC (ELV). Regarding the REACH Regulation, the information TE provides on SVHC in articles for this part number is based on the latest European Chemicals Agency (ECHA) 'Guidance on requirements for substances in articles' posted at this URL: <https://echa.europa.eu/guidance-documents/guidance-on-reach>

## Compatible Parts

 <p>TE Part # CAT-AM71-C83998C Circular Plastic Connector, CMC Series 1</p>	 <p>TE Part # CAT-AM71-C83998Y One-Piece Connector, Sealed, CPC Series 1</p>	 <p>TE Part # CAT-AM71-C83998J Cable/Panel Mount Connector, CPC Series 1</p>	 <p>TE Part # CAT-AM71-C83998K Circular Connector, Environmentally Sealed, CPC Series 6</p>
 <p>TE Part # 200893-2 INSERTION TOOL CONT</p>	 <p>TE Part # 539972-1 EXTRACTION TOOL</p>	 <p>TE Part # 305183 EXTRACT TOOL TYPE 2 20-16</p>	 <p>TE Part # 2305570-1 Strip Terminal Cutter-Side Feed-No Crimp</p>



Also in the Series | AMP Type III+

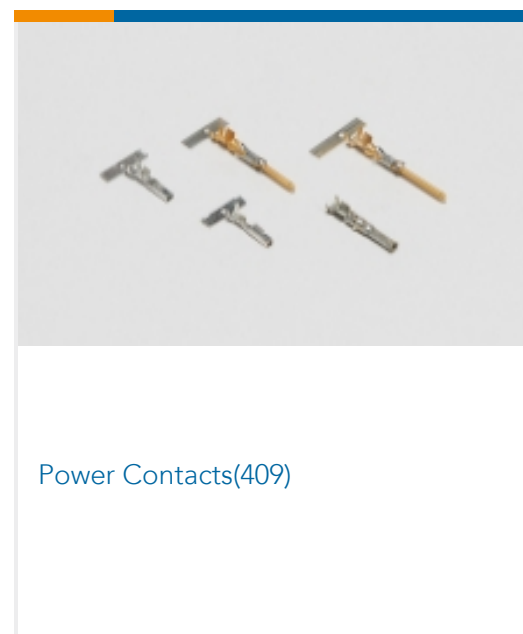
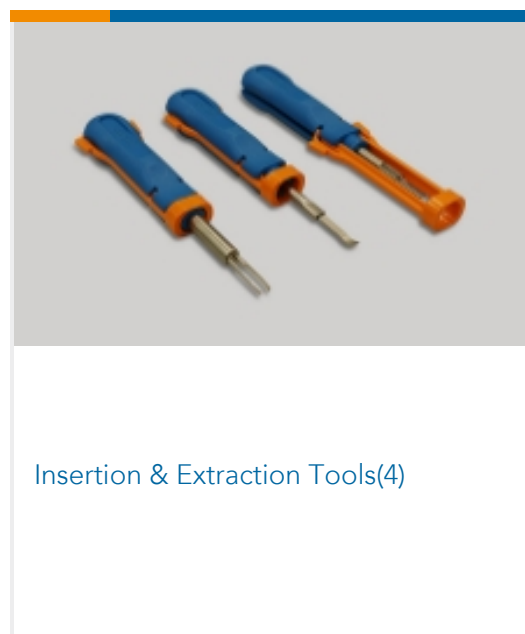

Customers Also Bought

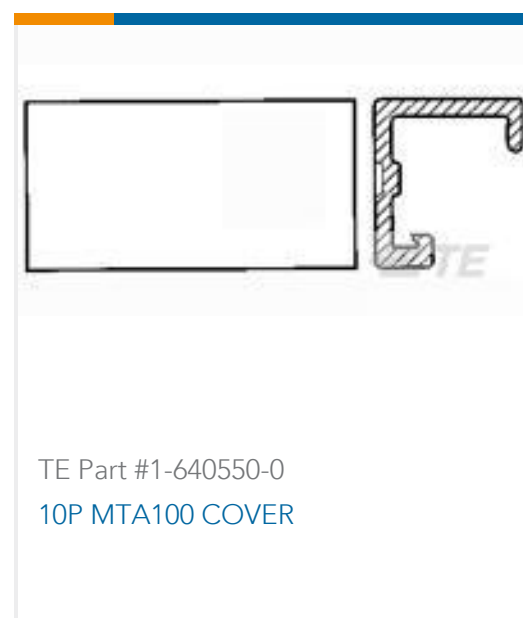

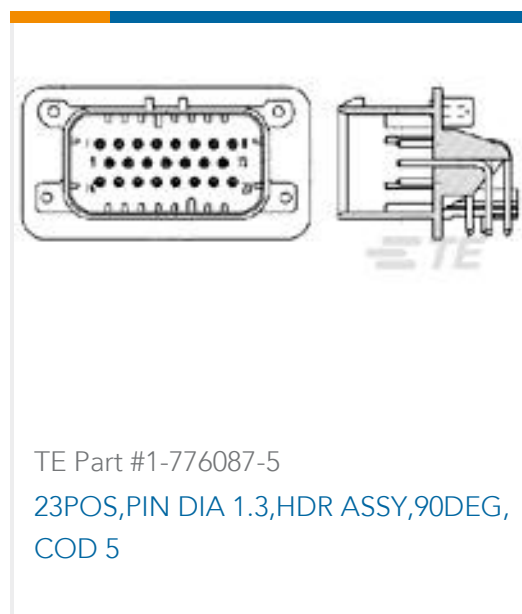

## Documents

### Product Drawings

III+ SKT,30-26,30AU/FL,STRIP

English

### CAD Files

3D PDF

3D

Customer View Model

[ENG\\_CVM\\_CVM\\_66394-8\\_AJ.2d\\_dxf.zip](#)

English

Customer View Model

[ENG\\_CVM\\_CVM\\_66394-8\\_AJ.3d\\_igs.zip](#)

English

Customer View Model

[ENG\\_CVM\\_CVM\\_66394-8\\_AJ.3d\\_stp.zip](#)

English

By downloading the CAD file I accept and agree to the [Terms and Conditions](#) of use.

### Datasheets & Catalog Pages

[AMP Circular Connectors for Commercial Signal & Power Applications](#)

English

### Signal Contacts

English

[M\\_SERIES\\_PIN\\_AND\\_SOCKET\\_CONNECTORS](#)

English

### Product Specifications

[Application Specification](#)

English

### Product Environmental Compliance

[TE Material Declaration](#)

English

### Instruction Sheets

[Instruction Sheet \(U.S.\)](#)



Japanese

[Instruction Sheet \(U.S.\)](#)

English