

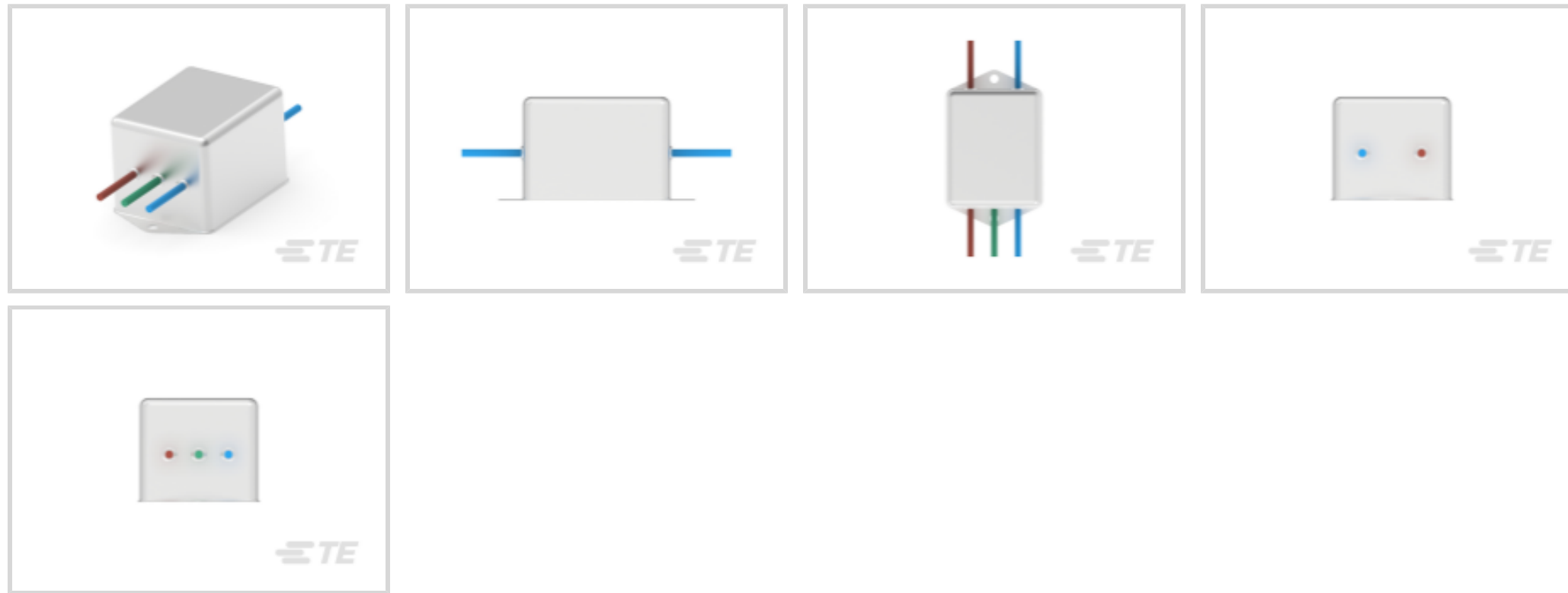

EMI & EMC Solutions > EMI Filters > Power Line Filters > Single Phase Filters > Single Phase Filters, Corcom Q Series



Current Rating: **3 A**

Input Termination Type: **Wire Lead**

Output Termination Type: **Wire Lead**

Leakage Current (Max) (120VAC, 60Hz): **.22 mA**

Leakage Current (Max) (250VAC, 50Hz): **.38 mA**

[All Single Phase Filters, Corcom Q Series \(15\)](#)

## Features

### Product Type Features

Ground Choke Option	No
Filtering Requirements	Filtered
Input Termination Type	Wire Lead
Output Termination Type	Wire Lead

### Electrical Characteristics

Operating Voltage	250 VAC
Current Rating	3 A
Leakage Current (Max) (120VAC, 60Hz)	.22 mA
Leakage Current (Max) (250VAC, 50Hz)	.38 mA

### Mechanical Attachment

Panel Mount Feature Type	Flanged
--------------------------	---------

### Usage Conditions

Operating Temperature Range	-10 – 40 °C
-----------------------------	-------------



## Product Compliance

[For compliance documentation, visit the product page on TE.com>](#)

EU RoHS Directive 2011/65/EU	Compliant
EU ELV Directive 2000/53/EC	Compliant
China RoHS 2 Directive MIIT Order No 32, 2016	No Restricted Materials Above Threshold
EU REACH Regulation (EC) No. 1907/2006	Current ECHA Candidate List: JUNE 2023 (235) Candidate List Declared Against: JUNE 2023 (235) Does not contain REACH SVHC
Halogen Content	Not Low Halogen - contains Br or Cl > 900 ppm.
Solder Process Capability	Not applicable for solder process capability

### Product Compliance Disclaimer

This information is provided based on reasonable inquiry of our suppliers and represents our current actual knowledge based on the information they provided. This information is subject to change. The part numbers that TE has identified as EU RoHS compliant have a maximum concentration of 0.1% by weight in homogenous materials for lead, hexavalent chromium, mercury, PBB, PBDE, DBP, BBP, DEHP, DIBP, and 0.01% for cadmium, or qualify for an exemption to these limits as defined in the Annexes of Directive 2011/65/EU (RoHS2). Finished electrical and electronic equipment products will be CE marked as required by Directive 2011/65/EU. Components may not be CE marked. Additionally, the part numbers that TE has identified as EU ELV compliant have a maximum concentration of 0.1% by weight in homogenous materials for lead, hexavalent chromium, and mercury, and 0.01% for cadmium, or qualify for an exemption to these limits as defined in the Annexes of Directive 2000/53/EC (ELV). Regarding the REACH Regulation, the information TE provides on SVHC in articles for this part number is based on the latest European Chemicals Agency (ECHA) 'Guidance on requirements for substances in articles' posted at this URL: <https://echa.europa.eu/guidance-documents/guidance-on-reach>

## Compatible Parts



Also in the Series | [Corcom Q](#)



Single Phase Filters(15)

### Customers Also Bought



TE Part #323008  
PIDG R 22-16 COMM 22-18 MIL 6



TE Part #2199119-3  
M.2 0.5PITCH 3.2H KEY B 15U" AU



TE Part #487406-4  
FFC RCPT CONT SP 100SNPB RL

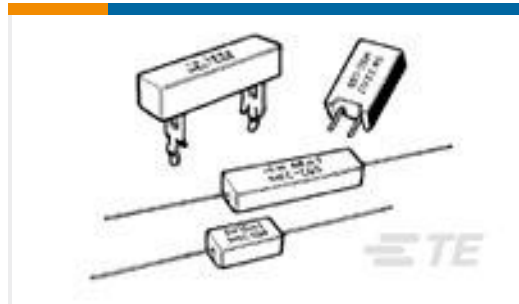

TE Part #1623779-5  
SQB20 10R 5%

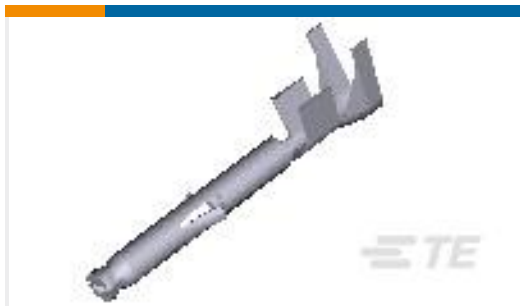

TE Part #770988-3  
MINI UMNL SOK 22-18AWG AU LP

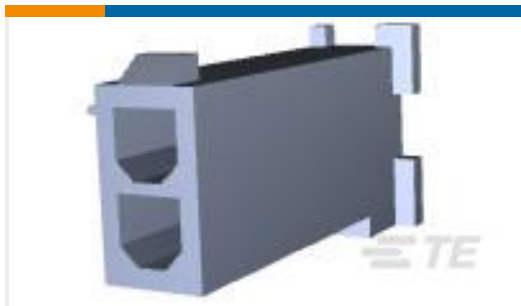

TE Part #172233-1  
2 POS MINI UMNL CAP HOUSING

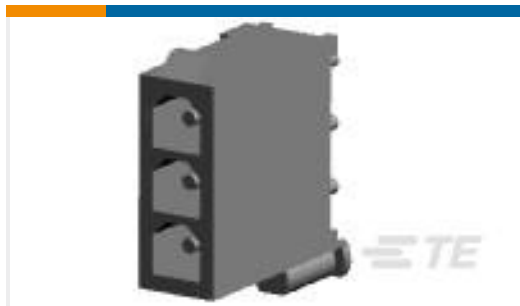

TE Part #770170-2  
03P MINI-UMNL ASSY VO SNAU

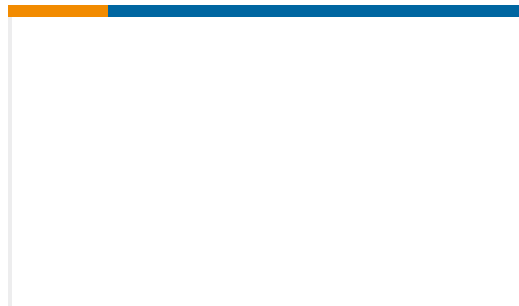

TE Part #ZPF000000000002122  
187-0108-08



TE Part #FDBA508E1PN090A499  
RECP ASSY

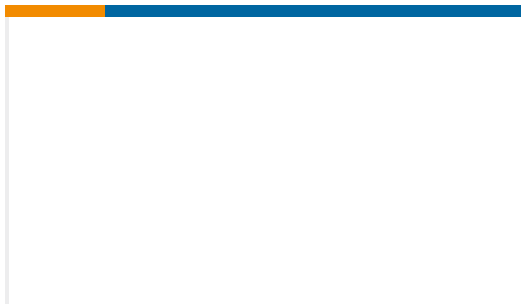

TE Part #ZPF0000000000098400  
164-8013-08 A499

### Documents

#### Product Drawings

[3EQ3=F7259 S0](#)

English

#### CAD Files

[Customer View Model](#)

[ENG\\_CVM\\_6609048-2\\_F.3d\\_igs.zip](#)

English

[Customer View Model](#)



[ENG\\_CVM\\_6609048-2\\_F.3d\\_stp.zip](#)

English

**Customer View Model**

[ENG\\_CVM\\_6609048-2\\_F.2d\\_dxf.zip](#)

English

**3D PDF**

English

**Customer View Model**

[ENG\\_CVM\\_CVM\\_6609048-2\\_F1.2d\\_dxf.zip](#)

English

**Customer View Model**

[ENG\\_CVM\\_CVM\\_6609048-2\\_F1.3d\\_igs.zip](#)

English

**Customer View Model**

[ENG\\_CVM\\_CVM\\_6609048-2\\_F1.3d\\_stp.zip](#)

English

**3D PDF**

3D

By downloading the CAD file I accept and agree to the [Terms and Conditions](#) of use.

### Datasheets & Catalog Pages

[1654001\\_CORCOM\\_PRODUCT\\_GUIDE](#)

English

[1654001\\_CORCOM\\_PRODUCT\\_GUIDE\\_Q\\_SERIES](#)

English

[Corcom Combined Selector Charts](#)

English

[1-1654250-1\\_CORCOM\\_EMI\\_RFI\\_QRG](#)

English