

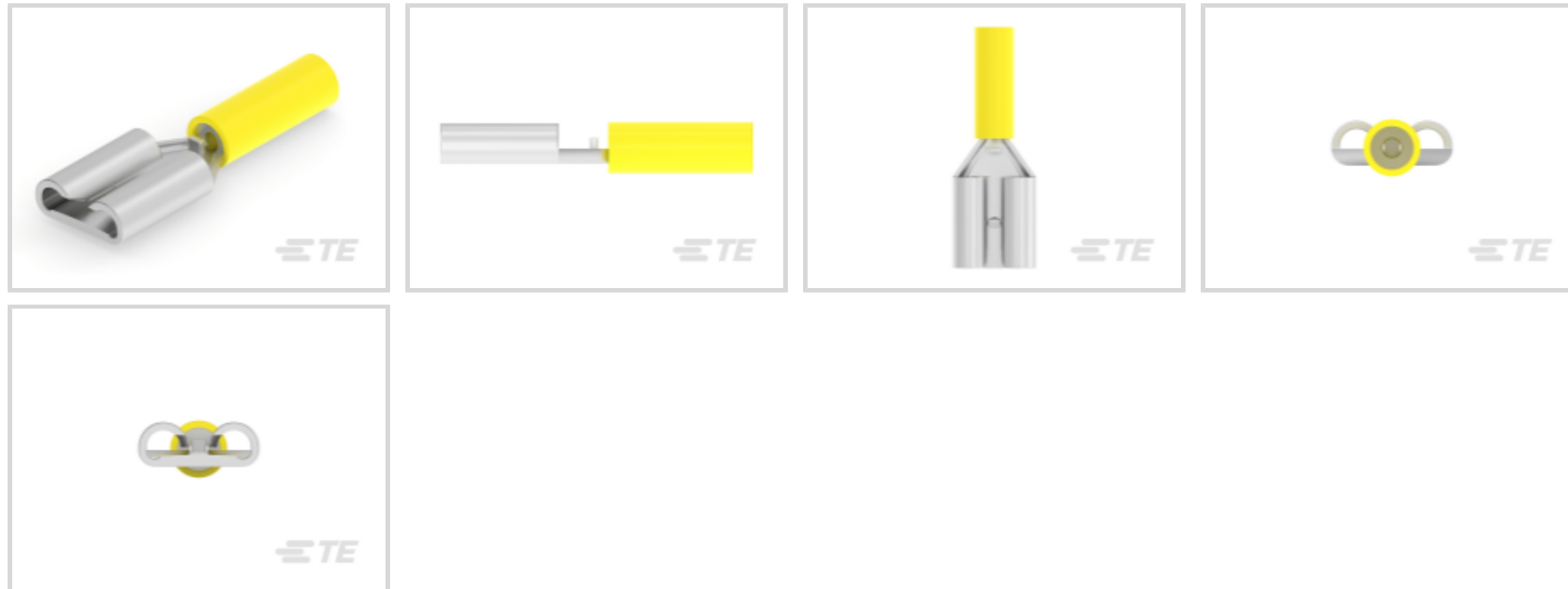

Terminals & Splices > Quick Disconnects



Quick Disconnect Terminal Type: **Receptacle**

Wire Size: **238 – 475 CMA**

Mating Tab Width: **4.75 mm [.187 in]**

Features

Product Type Features

Terminal Features	Wire Stop
Insertion Force	Normal

Electrical Characteristics

Voltage Rating	300 V
----------------	-------

Body Features

Insulation Material	Nylon
---------------------	-------

Contact Features

Quick Disconnect Terminal Type	Receptacle
Mating Tab Width	4.75 mm [.187 in]
Mating Tab Thickness	.51 mm [.02 in]
Terminal Orientation	Straight
Contact Base Material	Brass
Terminal Plating Material	Tin
Crimp Type	Compression
Barrel Type	Closed



Termination Features

Product Terminates To	Wire & Cable
-----------------------	--------------

Mechanical Attachment

Wire Insulation Support	With
Mating Retention Type	Dimple

Dimensions

Terminal Material Thickness	.41 mm[.016 in]
Product Length	17.81 mm[.7 in]
Compatible Insulation Diameter Range	2.08 mm[.082 in]
Wire Size	238 – 475 CMA

Usage Conditions

Insulation Option	Partially Insulated
Operating Temperature Range	105 °C[221 °F]

Packaging Features

Packaging Quantity	5000
Packaging Method	Package

Other

Barrel Color	Yellow
--------------	--------

Product Compliance

[For compliance documentation, visit the product page on TE.com>](#)

EU RoHS Directive 2011/65/EU	Compliant
EU ELV Directive 2000/53/EC	Compliant
China RoHS 2 Directive MIIT Order No 32, 2016	No Restricted Materials Above Threshold
EU REACH Regulation (EC) No. 1907/2006	Current ECHA Candidate List: JUNE 2023 (235) Candidate List Declared Against: JUNE 2023 (235) Does not contain REACH SVHC
Halogen Content	Low Halogen - Br, Cl, F, I < 900 ppm per homogenous material. Also BFR/CFR/PVC Free
Solder Process Capability	Not applicable for solder process capability

Product Compliance Disclaimer

This information is provided based on reasonable inquiry of our suppliers and represents our current actual knowledge based on the information they provided. This information is subject to change. The part numbers that TE has identified as EU RoHS compliant have a maximum concentration of 0.1% by weight in homogenous materials for lead, hexavalent chromium, mercury, PBB, PBDE, DBP, BBP, DEHP, DIBP, and 0.01% for cadmium, or qualify for an exemption to these limits as defined in the Annexes of Directive 2011/65/EU (RoHS2). Finished electrical and electronic equipment products will be CE marked as required by Directive 2011/65/EU. Components may not be CE marked. Additionally, the part numbers that TE has identified as EU ELV compliant have a maximum concentration of 0.1% by weight in homogenous materials for lead, hexavalent chromium, and mercury, and 0.01% for cadmium, or qualify for an exemption to these limits as defined in the Annexes of Directive 2000/53/EC (ELV). Regarding the REACH Regulation, the information TE provides on SVHC in articles for this part number is based on the latest European Chemicals Agency (ECHA) 'Guidance on requirements for substances in articles' posted at this URL: <https://echa.europa.eu/guidance-documents/guidance-on-reach>

Compatible Parts



Also in the Series | FASTON 187

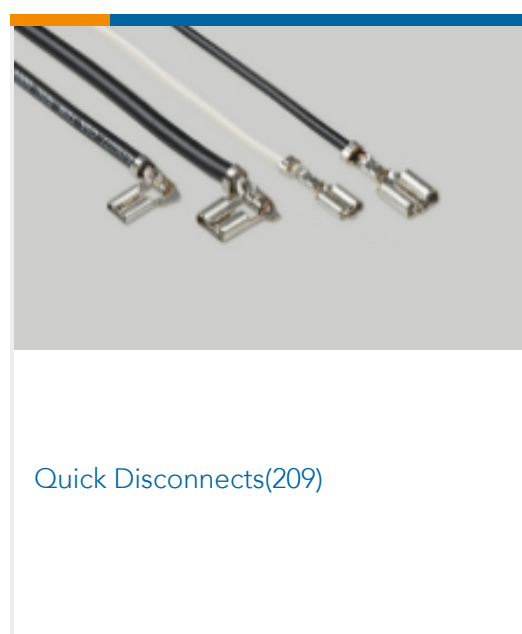
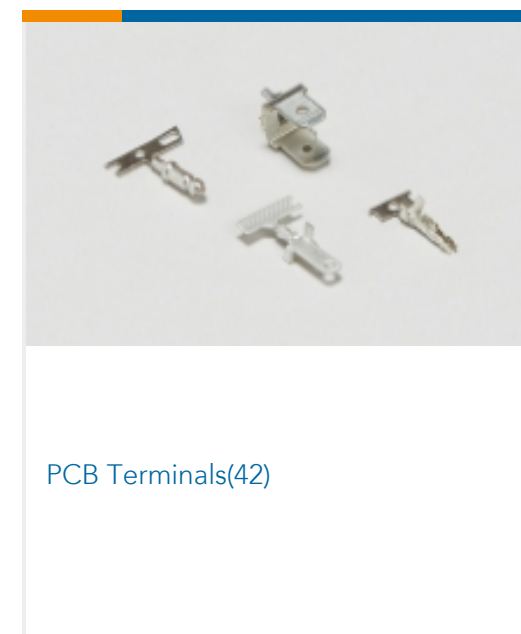
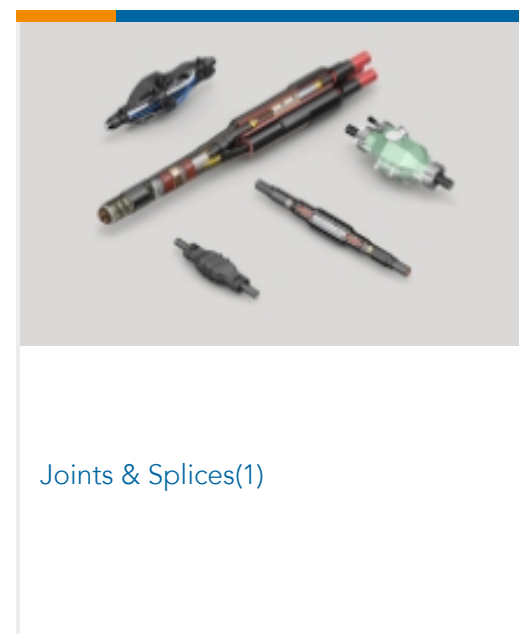
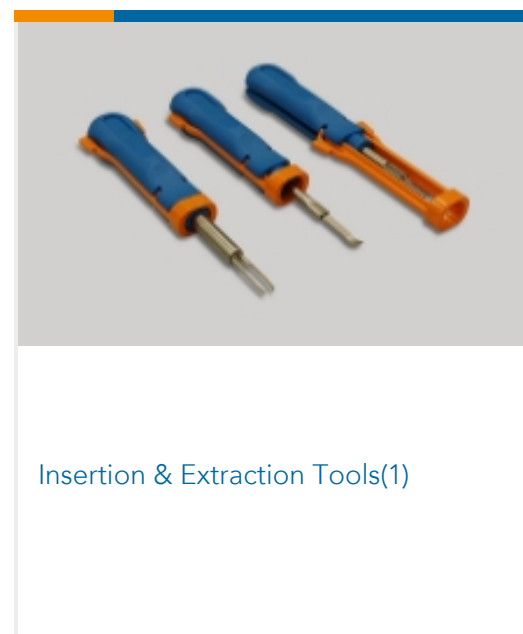
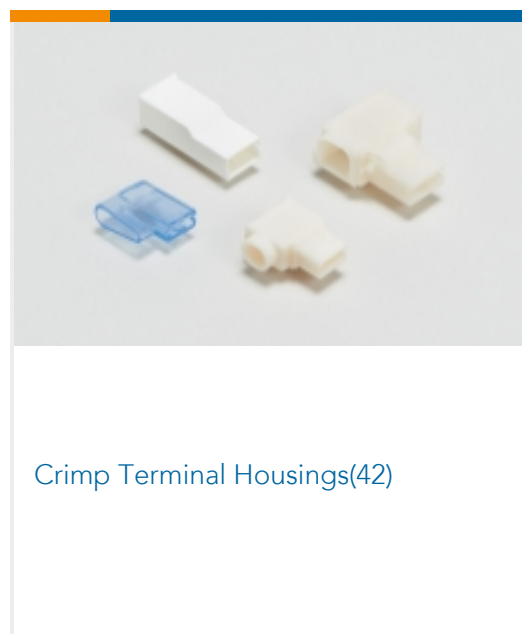

Customers Also Bought

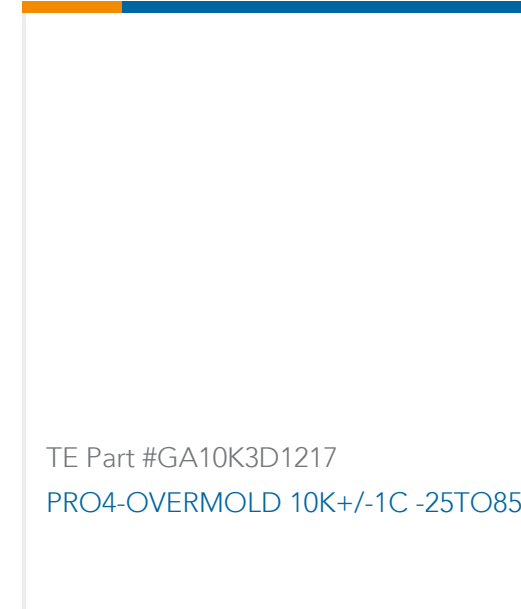
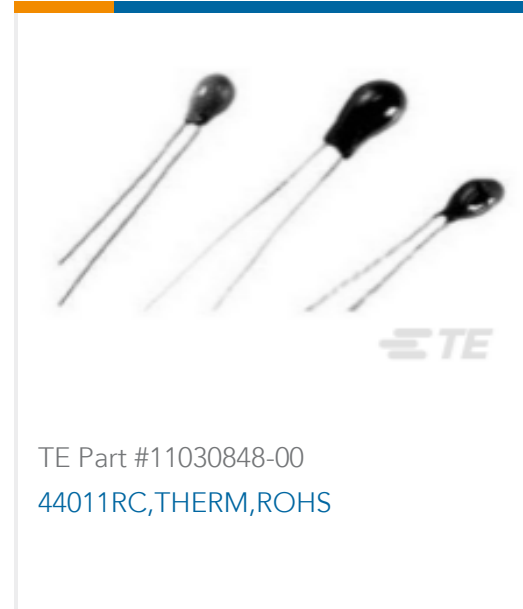
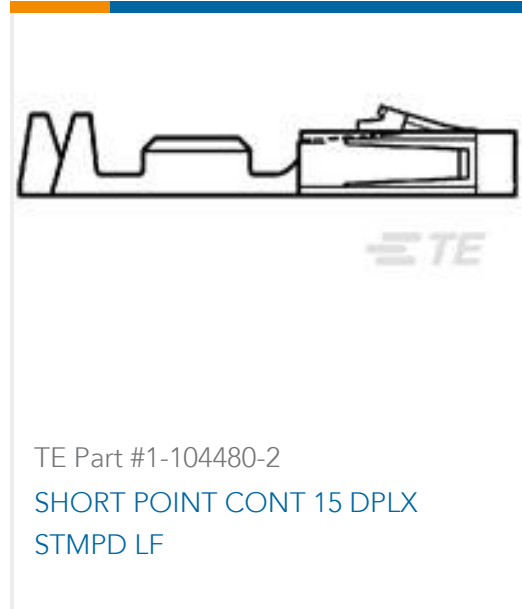

Documents

Product Drawings

[RECEPT IDG FASTON 26-24 187](#)

English

CAD Files

[3D PDF](#)

English

Customer View Model

[ENG_CVM_641321-2_H.3d_igs.zip](#)

English

Customer View Model

[ENG_CVM_641321-2_H.3d_stp.zip](#)

English

Customer View Model

[ENG_CVM_641321-2_H.2d_dxf.zip](#)

English

[3D PDF](#)

3D



Customer View Model

[ENG_CVM_CVM_641321-2_F.2d_dxf.zip](#)

English

Customer View Model

[ENG_CVM_CVM_641321-2_F.3d_igs.zip](#)

English

Customer View Model

[ENG_CVM_CVM_641321-2_F.3d_stp.zip](#)

English

By downloading the CAD file I accept and agree to the [Terms and Conditions](#) of use.

Datasheets & Catalog Pages

[PIDG_FASTON](#)

English

[Ultra-Fast and Ultra Fast Plus](#)

English

Product Specifications

[Application Specification](#)

English

Product Environmental Compliance

[MD_641321-2_10072013112_dmtec](#)

English

[MD_641321-2_10072013112_dmtec](#)

English

Agency Approvals

[CSA Certificate](#)

English