

641321-1 ✓ ACTIVE

## PIDG

TE Internal #: 641321-1

Quick Disconnects, Receptacle, 26 – 24 AWG Wire Size, .12 – .20 mm<sup>2</sup> Wire Size, 238 – 475 CMA Wire Size, Mating Tab Width 4.75 mm [.187 in], PIDG

[View on TE.com >](#)



Terminals & Splices > Quick Disconnects > PIDG FASTON Receptacle Quick Disconnects

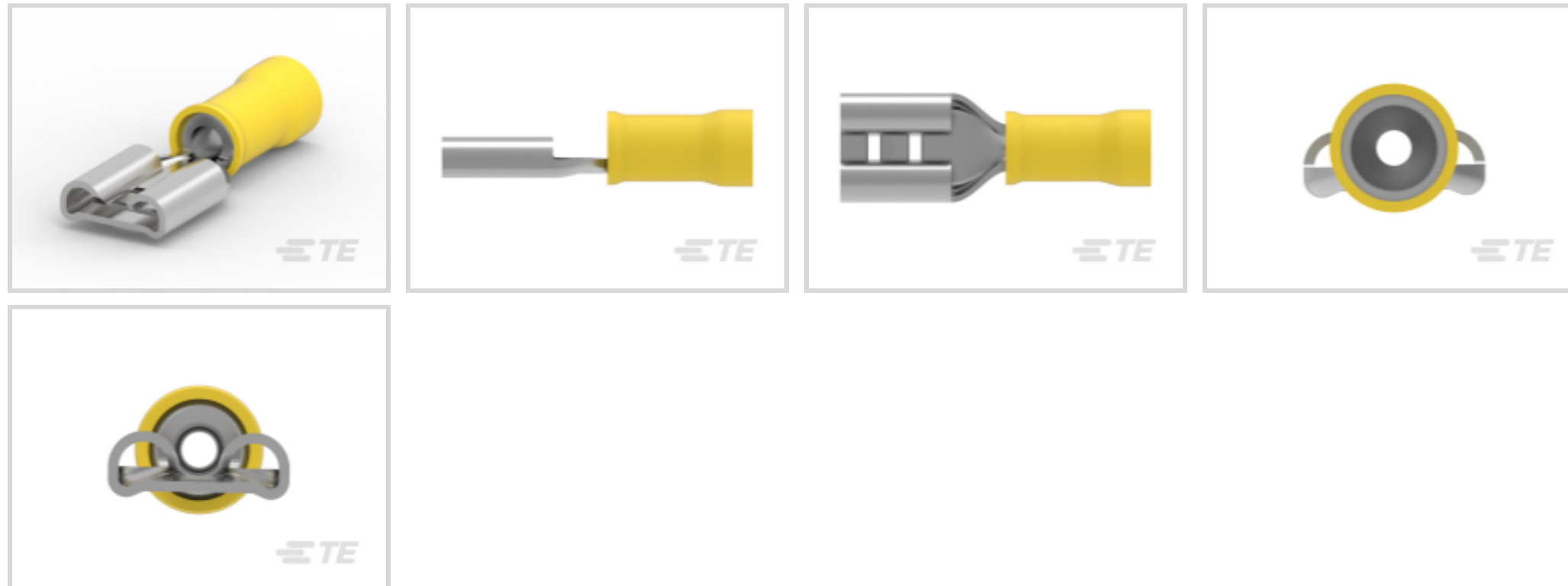

Quick Disconnect Terminal Type: **Receptacle**

Wire Size: **238 – 475 CMA**

Mating Tab Width: **4.75 mm [.187 in]**

[All PIDG FASTON Receptacle Quick Disconnects \(21\)](#)

## Features

### Product Type Features

Terminal Features	Wire Stop
Insertion Force	Normal

### Electrical Characteristics

Voltage Rating	300 V
----------------	-------

### Body Features

Insulation Material	Nylon
---------------------	-------

### Contact Features

Quick Disconnect Terminal Type	Receptacle
Mating Tab Width	4.75 mm [.187 in]
Mating Tab Thickness	.51 mm [.02 in]
Terminal Orientation	Straight
Contact Base Material	Brass
Terminal Plating Material	Tin
Crimp Type	Compression



Barrel Type	Closed
-------------	--------

### Termination Features

Product Terminates To	Wire & Cable
-----------------------	--------------

### Mechanical Attachment

Wire Insulation Support	With
-------------------------	------

Mating Retention Type	Dimple
-----------------------	--------

### Dimensions

Terminal Material Thickness	.41 mm[.016 in]
-----------------------------	-----------------

Product Length	17.81 mm[.7 in]
----------------	-----------------

Compatible Insulation Diameter Range	2.08 mm[.082 in]
--------------------------------------	------------------

Wire Size	238 – 475 CMA
-----------	---------------

### Usage Conditions

Insulation Option	Partially Insulated
-------------------	---------------------

Operating Temperature Range	105 °C[221 °F]
-----------------------------	----------------

### Packaging Features

Packaging Quantity	1000
--------------------	------

Packaging Method	Loose Piece
------------------	-------------

### Other

Barrel Color	Yellow
--------------	--------

## Product Compliance

[For compliance documentation, visit the product page on TE.com>](#)

EU RoHS Directive 2011/65/EU	Compliant
------------------------------	-----------

EU ELV Directive 2000/53/EC	Compliant
-----------------------------	-----------

China RoHS 2 Directive MIIT Order No 32, 2016	No Restricted Materials Above Threshold
---	---

EU REACH Regulation (EC) No. 1907/2006	Current ECHA Candidate List: JUNE 2023 (235) Candidate List Declared Against: JUNE 2023 (235) Does not contain REACH SVHC
--	---

Halogen Content	Low Halogen - Br, Cl, F, I < 900 ppm per homogenous material. Also BFR/CFR/PVC Free
-----------------	---

Solder Process Capability	Not applicable for solder process capability
---------------------------	--

Product Compliance Disclaimer

This information is provided based on reasonable inquiry of our suppliers and represents our current actual knowledge based on the information they provided. This information is subject to change. The part numbers that TE has identified as EU RoHS compliant have a maximum concentration of 0.1% by weight in homogenous materials for lead, hexavalent chromium, mercury, PBB, PBDE, DBP, BBP, DEHP, DIBP, and 0.01% for cadmium, or qualify for an exemption to these limits as defined in the Annexes of Directive 2011/65/EU (RoHS2). Finished electrical and electronic equipment products will be CE marked as required by Directive 2011/65/EU. Components may not be CE marked. Additionally, the part numbers that TE has identified as EU ELV compliant have a maximum concentration of 0.1% by weight in homogenous materials for lead, hexavalent chromium, and mercury, and 0.01% for cadmium, or qualify for an exemption to these limits as defined in the Annexes of Directive 2000/53/EC (ELV). Regarding the REACH Regulation, the information TE provides on SVHC in articles for this part number is based on the latest European Chemicals Agency (ECHA) 'Guidance on requirements for substances in articles' posted at this URL: <https://echa.europa.eu/guidance-documents/guidance-on-reach>

## Compatible Parts



REPRESENTATION ONLY

TE Part # 169485  
DAHT PIDG PG 26-22 ASSY



REPRESENTATION ONLY

TE Part # 48518-2  
DAHT PIDG FASTON 26-24 ASSY

## Also in the Series | PIDG



Compression Connectors(17)



Crimp Terminal Housings(1)



Crimp Wire Pins, Tabs & Ferrules(41)



Hand Crimping Tools(2)



Knife Disconnects(11)



PCB Terminals(7)



Quick Disconnects(49)



Ring Terminals(611)



Spade Terminals(233)

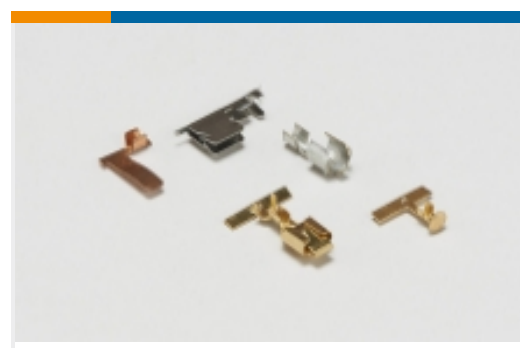

Special Purpose Terminals(1)



Splices(46)

## Customers Also Bought

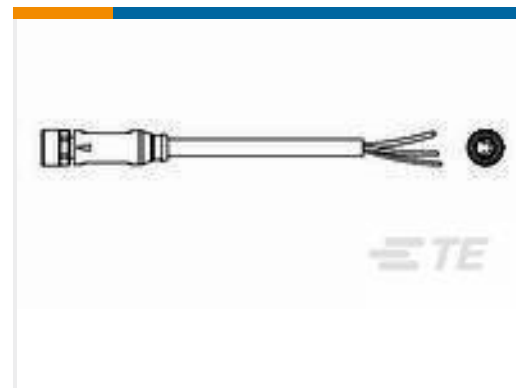
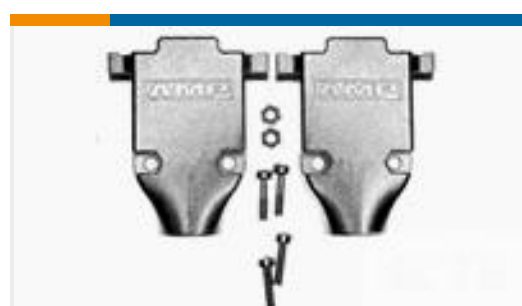
TE Part #54010-1  
CPC STRAIN RELIEF,SIZE 11TE Part #66400-3  
Pin and Socket Contacts, Type III, LPTE Part #1-2273005-1  
M8 x 1.0 straight socket Pigtail ShldTE Part #5745171-5  
AMPL CBL CLMP KIT SZ 1TE Part #5745171-2  
SIZE 1 ASSY KIT .200TE Part #3-640600-3  
03P MTA156 CONN ASSY 20AWG LFTE Part #1734098-4  
Champ050 40p A/P RCPT 25CL PBTE Part #1-6609032-9  
20VR6=F7312 S0

## Documents

### Product Drawings

[RECEPT PIDG FASTON 26-24 187](#)

English

### CAD Files

[3D PDF](#)

English

Customer View Model

[ENG\\_CVM\\_641321-1\\_H.3d\\_igs.zip](#)

English

Customer View Model

[ENG\\_CVM\\_641321-1\\_H.3d\\_stp.zip](#)

English

Customer View Model

[ENG\\_CVM\\_641321-1\\_H.2d\\_dxf.zip](#)

English

[3D PDF](#)



3D

Customer View Model

[ENG\\_CVM\\_CVM\\_641321-1\\_F.2d\\_dxf.zip](#)

English

Customer View Model

[ENG\\_CVM\\_CVM\\_641321-1\\_F.3d\\_igs.zip](#)

English

Customer View Model

[ENG\\_CVM\\_CVM\\_641321-1\\_F.3d\\_stp.zip](#)

English

By downloading the CAD file I accept and agree to the [Terms and Conditions](#) of use.

---

## Datasheets & Catalog Pages

[PIDG\\_FASTON](#)

English

[Ultra-Fast and Ultra Fast Plus](#)

English

[PIDG TERMINALS & SPLICES Quick Reference Guide](#)

English

---

## Product Specifications

[Application Specification](#)

English

---

## Product Environmental Compliance

[MD\\_641321-1\\_032820181319\\_dmtec](#)

English

[MD\\_641321-1\\_032820181319\\_dmtec](#)

English

---

## Agency Approvals

[Agency Approval Document](#)

English