



PIDG

TE Internal #: 640905-1

Quick Disconnects, Receptacle, 16 – 14 AWG Wire Size, 1.04 – 2.62 mm² Wire Size, 2050 – 5180 CMA Wire Size, Mating Tab Width 6.35 mm [.25 in], PIDG

[View on TE.com >](#)

Terminals & Splices > Quick Disconnects > PIDG FASTON Receptacle Quick Disconnects

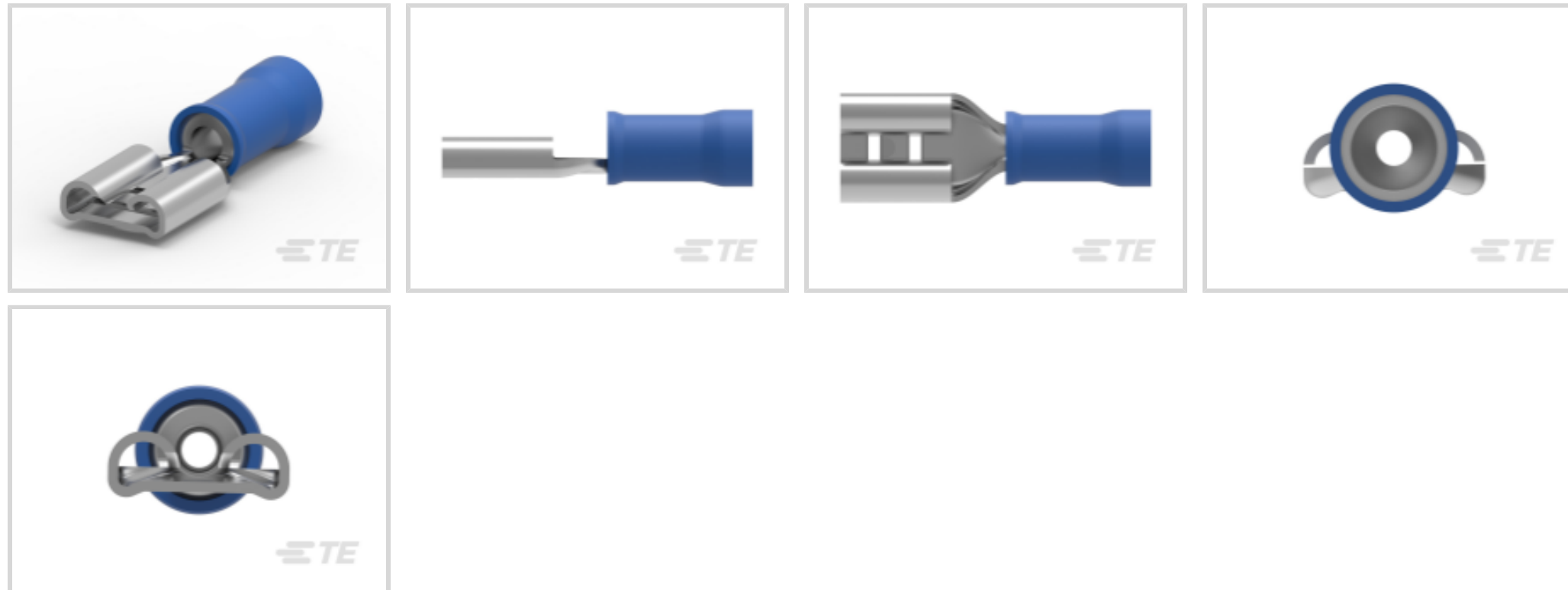

Quick Disconnect Terminal Type: **Receptacle**

Wire Size: **2050 – 5180 CMA**

Mating Tab Width: **6.35 mm [.25 in]**

[All PIDG FASTON Receptacle Quick Disconnects \(21\)](#)

Features

Product Type Features

Terminal Features	Wire Stop
Insertion Force	Normal

Electrical Characteristics

Voltage Rating	300 V
----------------	-------

Body Features

Insulation Material	Nylon
---------------------	-------

Contact Features

Quick Disconnect Terminal Type	Receptacle
Mating Tab Width	6.35 mm [.25 in]
Mating Tab Thickness	.81 mm [.032 in]
Terminal Orientation	Straight
Contact Base Material	Brass
Terminal Plating Material	Tin
Crimp Type	Compression



Barrel Type	Closed
-------------	--------

Termination Features

Product Terminates To	Wire & Cable
-----------------------	--------------

Mechanical Attachment

Wire Insulation Support	With
-------------------------	------

Mating Retention Type	Dimple
-----------------------	--------

Dimensions

Terminal Material Thickness	.46 mm[.018 in]
-----------------------------	-----------------

Product Length	22.9 mm[.9 in]
----------------	----------------

Compatible Insulation Diameter Range	4.32 mm[.17 in]
--------------------------------------	-----------------

Wire Size	2050 – 5180 CMA
-----------	-----------------

Usage Conditions

Insulation Option	Partially Insulated
-------------------	---------------------

Operating Temperature Range	105 °C[221 °F]
-----------------------------	----------------

Industry Standards

Agency/Standard	CSA, RU (UL Component Program)
-----------------	--------------------------------

Packaging Features

Packaging Quantity	1000
--------------------	------

Packaging Method	Loose Piece
------------------	-------------

Other

Barrel Color	Blue
--------------	------

Product Compliance

[For compliance documentation, visit the product page on TE.com>](#)

EU RoHS Directive 2011/65/EU	Compliant
------------------------------	-----------

EU ELV Directive 2000/53/EC	Compliant
-----------------------------	-----------

China RoHS 2 Directive MIIT Order No 32, 2016	No Restricted Materials Above Threshold
---	---

EU REACH Regulation (EC) No. 1907/2006	Current ECHA Candidate List: JUNE 2023 (235) Candidate List Declared Against: JUNE 2023 (235) Does not contain REACH SVHC
--	---

Halogen Content	Low Halogen - Br, Cl, F, I < 900 ppm per
-----------------	--

homogenous material. Also BFR/CFR/PVC Free

Solder Process Capability

Not applicable for solder process capability

Product Compliance Disclaimer

This information is provided based on reasonable inquiry of our suppliers and represents our current actual knowledge based on the information they provided. This information is subject to change. The part numbers that TE has identified as EU RoHS compliant have a maximum concentration of 0.1% by weight in homogenous materials for lead, hexavalent chromium, mercury, PBB, PBDE, DBP, BBP, DEHP, DIBP, and 0.01% for cadmium, or qualify for an exemption to these limits as defined in the Annexes of Directive 2011/65/EU (RoHS2). Finished electrical and electronic equipment products will be CE marked as required by Directive 2011/65/EU. Components may not be CE marked. Additionally, the part numbers that TE has identified as EU ELV compliant have a maximum concentration of 0.1% by weight in homogenous materials for lead, hexavalent chromium, and mercury, and 0.01% for cadmium, or qualify for an exemption to these limits as defined in the Annexes of Directive 2000/53/EC (ELV). Regarding the REACH Regulation, the information TE provides on SVHC in articles for this part number is based on the latest European Chemicals Agency (ECHA) 'Guidance on requirements for substances in articles' posted at this URL: <https://echa.europa.eu/guidance-documents/guidance-on-reach>

Compatible Parts



TE Part # 59824-1
TETRA-CRIMP PIDG PG FASTON 22-10 ASSY



TE Part # 58423-1
DIE, RBY IS9252



TE Part # 47387-7
DAHT PG PIDG 16-12 ASSY



TE Part # 58433-3
PRO CR ASSY, RBY IS9252



TE Part # 90009-8
DAHT PIDG FASTON 16-14 ASSY



TE Part # 1SET191002R0000
TET CRIMP-HT

Also in the Series | PIDG



Compression Connectors(17)

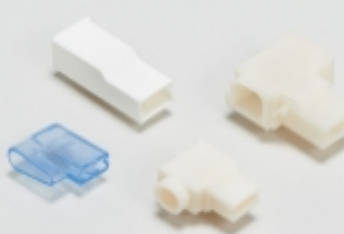

Crimp Terminal Housings(1)



Crimp Wire Pins, Tabs & Ferrules(41)



Hand Crimping Tools(2)



Knife Disconnects(11)



PCB Terminals(7)

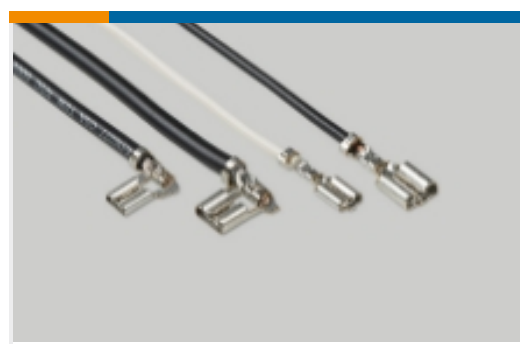

Quick Disconnects(49)



Ring Terminals(607)

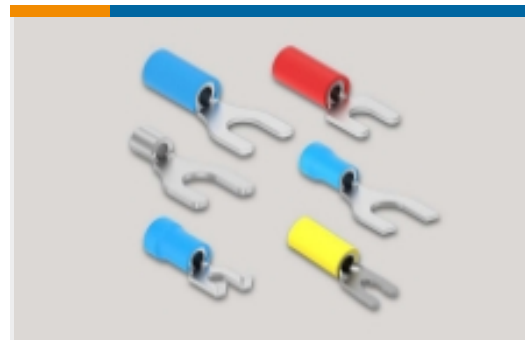

Spade Terminals(231)

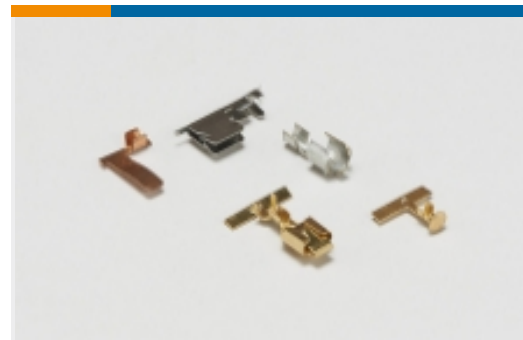

Special Purpose Terminals(1)



Splices(45)

Customers Also Bought



TE Part #5414946-2
PLUG, CBL, STR, SMB, PB FREE



TE Part #2120947-1
M12 DC POWER PLUG CONNECTOR, T-CODED



TE Part #076-10005-10
ML-11 TEMP. SENSOR 10 FT



TE Part #LL01-1AB04
LL01 1/2" NPT 48" CABLE 80C

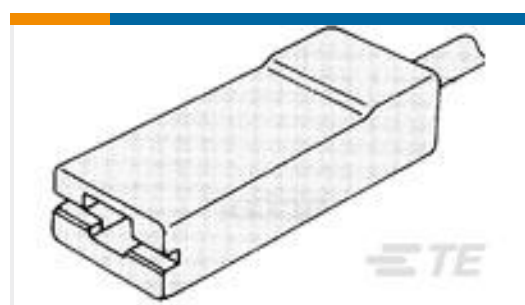

TE Part #1-1659282-0
H2804/5000



TE Part #1-1659321-0
H30013/5000



TE Part #9-1879335-0
CPF 0603 182R 1% 50PPM 1K RL



TE Part #1918934-3
STD CABLE ADAPTER, No Boot, HA, 5.0 mm



TE Part #YMC8016-F-13-04SN0
ARINC 801, 38999 STYLE, SIZE 13-04



TE Part #11011542-00
ML-11,0-10 W/SMB,CONT LVL DIS

Documents



Product Drawings

RECEPT,PIDG FASTON 16-14 250

English

CAD Files

3D PDF

English

Customer View Model

[ENG_CVM_640905-1_N1.2d_dxf.zip](#)

English

Customer View Model

[ENG_CVM_640905-1_N1.3d_igs.zip](#)

English

Customer View Model

[ENG_CVM_640905-1_N1.3d_stp.zip](#)

English

3D PDF

3D

Customer View Model

[ENG_CVM_CVM_640905-1_N.2d_dxf.zip](#)

English

Customer View Model

[ENG_CVM_CVM_640905-1_N.3d_igs.zip](#)

English

Customer View Model

[ENG_CVM_CVM_640905-1_N.3d_stp.zip](#)

English

By downloading the CAD file I accept and agree to the [Terms and Conditions](#) of use.

Datasheets & Catalog Pages

PIDG_FASTON

English

Ultra-Fast and Ultra Fast Plus

English

PIDG TERMINALS & SPLICES Quick Reference Guide

English

Product Specifications

Application Specification

English

Product Environmental Compliance

Product Compliance Document

English

Product Compliance Document

English



[Agency Approvals](#)

[UL Report](#)

English