



MTA 156

TE Internal #: 640388-8

Rectangular Power Connectors, Header, Plug, Wire-to-Board, 8 Position, 3.96 mm [.156 in] Centerline, Printed Circuit Board, UL 94V-0, MTA 156

[View on TE.com >](#)

Connectors > Power Connectors > Rectangular Power > Rectangular Power Connectors

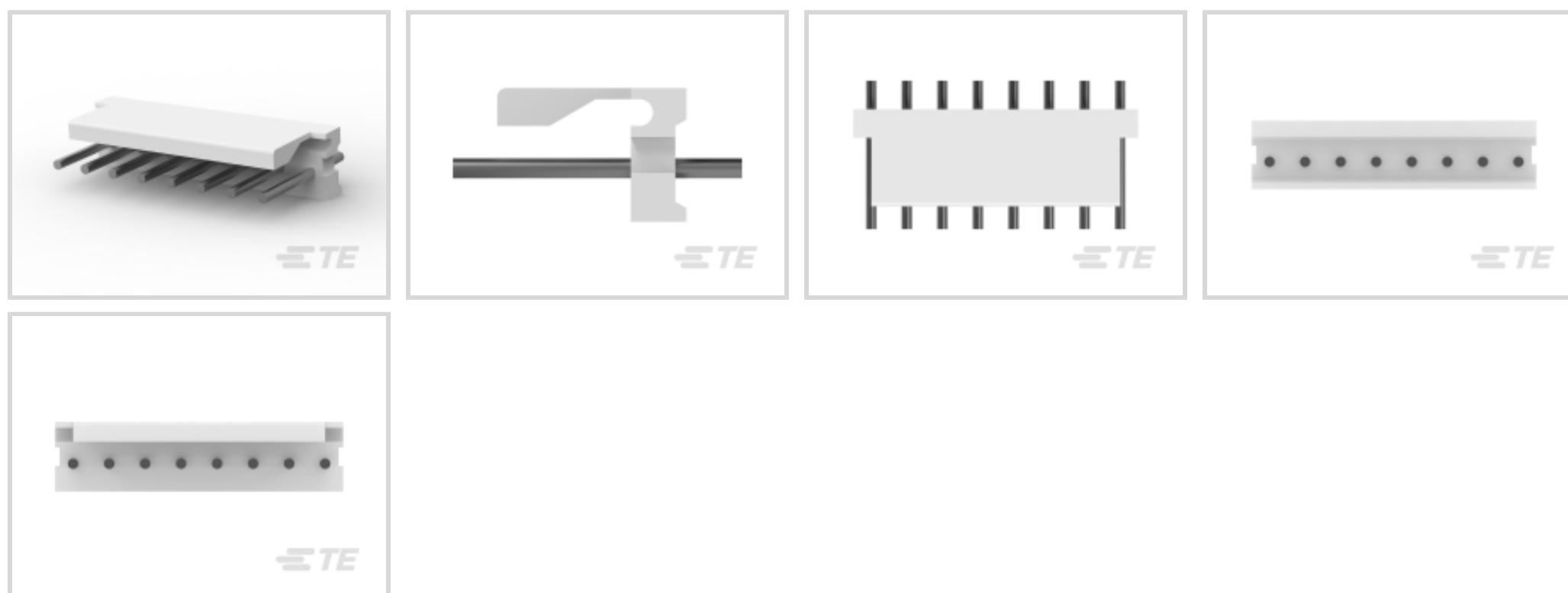

Rectangular Power Connector Type: **Header**

Connector & Housing Type: **Plug**

Connector System: **Wire-to-Board**

Number of Positions: **8**

Centerline (Pitch): **3.96 mm [.156 in]**

Features

Product Type Features

Header Type	Partially Shrouded
Rectangular Power Connector Type	Header
Connector & Housing Type	Plug
Connector System	Wire-to-Board
Sealable	No
Connector & Contact Terminates To	Printed Circuit Board

Configuration Features

Number of Positions	8
PCB Mount Orientation	Vertical
Number of Power Positions	8
Number of Rows	1

Electrical Characteristics

Operating Voltage	600 VAC
-------------------	---------

Contact Features



Mating Post Length	10.16 mm[.4 in]
	150 – 250 µin
Contact Layout	Inline
Contact Mating Area Plating Material	Tin
Contact Underplating Material	Nickel
Contact Base Material	Copper Alloy
Contact Current Rating (Max)	7 A
Contact Retention Within Housing	Without
Contact Type	Pin
PCB Contact Termination Area Plating Material	Tin
Contact Mating Area Plating Material Thickness	2.54 µm[100 µin]

Termination Features

Termination Post & Tail Length	3.56 mm[.14 in]
Termination Method to Printed Circuit Board	Through Hole - Solder

Mechanical Attachment

Strain Relief	Without
Mating Retention	With
Mating Alignment	Without
PCB Mount Alignment	Without
Panel Mount Feature	Without
PCB Mount Retention	Without
Mating Retention Type	Friction Lock
Connector Mounting Type	Board Mount

Housing Features

Centerline (Pitch)	3.96 mm[.156 in]
Housing Color	Natural
Housing Material	Polyester

Dimensions

Connector Height	10.79 mm[.425 in]
PCB Thickness (Recommended)	1.6 mm[.063 in]
Product Length	31.7 mm[1.248 in]

Usage Conditions



Operating Temperature Range	-55 – 105 °C[-67 – 221 °F]
-----------------------------	----------------------------

Operation/Application

Circuit Application	Power
---------------------	-------

Industry Standards

CSA Rating	Certified, LR 7189
UL Rating	Recognized
Agency/Standard	CSA, UL
Approved Standards	UL E28476
UL Flammability Rating	UL 94V-0
Glow Wire Rating	Standard Part - Not Glow Wire

Packaging Features

Packaging Quantity	2000
Packaging Method	Package

Product Compliance

[For compliance documentation, visit the product page on TE.com>](#)

EU RoHS Directive 2011/65/EU	Compliant
EU ELV Directive 2000/53/EC	Compliant
China RoHS 2 Directive MIIT Order No 32, 2016	No Restricted Materials Above Threshold
EU REACH Regulation (EC) No. 1907/2006	Current ECHA Candidate List: JUNE 2023 (235) Candidate List Declared Against: JUNE 2023 (235) Does not contain REACH SVHC
Halogen Content	Not Low Halogen - contains Br or Cl > 900 ppm.
Solder Process Capability	Wave solder capable to 265°C

Product Compliance Disclaimer

This information is provided based on reasonable inquiry of our suppliers and represents our current actual knowledge based on the information they provided. This information is subject to change. The part numbers that TE has identified as EU RoHS compliant have a maximum concentration of 0.1% by weight in homogenous materials for lead, hexavalent chromium, mercury, PBB, PBDE, DBP, BBP, DEHP, DIBP, and 0.01% for cadmium, or qualify for an exemption to these limits as defined in the Annexes of Directive 2011/65/EU (RoHS2). Finished electrical and electronic equipment products will be CE marked as required by Directive 2011/65/EU. Components may not be CE marked. Additionally, the part numbers that TE has identified as EU ELV compliant have a maximum concentration of 0.1% by weight in homogenous materials for lead, hexavalent chromium, and mercury, and 0.01% for cadmium, or qualify for an exemption to these limits as defined in the Annexes of Directive 2000/53/EC (ELV). Regarding the REACH Regulation, the information TE provides on SVHC in articles for this part number is based on the latest European Chemicals Agency (ECHA) 'Guidance on requirements for substances in articles' posted at this URL: <https://echa.europa.eu/guidance-documents/guidance-on-reach>

Compatible Parts

 <p>TE Part # CAT-103156-WBHSM Receptacle Housing: Wire-to-Board, with Mating Alignment, SL156</p>	 <p>TE Part # 640251-8 08P SL156 HSG W/O LCK RAMP</p>	 <p>TE Part # 3-640606-8 08P MTA156 CONN ASSY 22AWG LF</p>	 <p>TE Part # 3-640427-8 08P MTA156 CONN ASSY 20AWG YEL</p>
 <p>TE Part # 3-640602-8 08P MTA156 CONN ASSY 24AWG LF</p>	 <p>TE Part # 3-643818-8 08P MTA156 CONN ASSY 20AWG YEL</p>	 <p>TE Part # 3-640426-8 08P MTA156 CONN ASSY 18AWG ORA</p>	 <p>TE Part # 3-643819-8 08P MTA156 CONN ASSY 22AWG RED</p>
 <p>TE Part # 3-640434-8 08P MTA156 CONN ASSY 24AWG WHT</p>	 <p>TE Part # 3-640604-8 08P MTA156 CONN ASSY 18AWG LF</p>	 <p>TE Part # 1-641938-1 08P MTA156 HDR ASSY STR F/L W/</p>	 <p>TE Part # 3-640430-8 08P MTA156 CONN ASSY 26AWG BLU</p>
 <p>TE Part # 3-640429-8 08P MTA156 CONN ASSY 24AWG WHT</p>	 <p>TE Part # 3-640431-8 08P MTA156 CONN ASSY 18AWG ORA</p>	 <p>TE Part # 640551-8 08P MTA156 COVER</p>	 <p>TE Part # 3-644463-8 08P MTA156 CONN ASSY 22AWG RED</p>
 <p>TE Part # 643071-8 08P MTA156 FD-THRU COVER</p>	 <p>TE Part # 3-640428-8 08P MTA156 CONN ASSY 22AWG RED</p>	 <p>TE Part # 3-640599-8 08P MTA156 CONN ASSY 18AWG ORA</p>	 <p>TE Part # 3-643817-8 08P MTA156 CONN ASSY 18AWG ORA</p>

Also in the Series | MTA 156



Insertion & Extraction Tools(1)

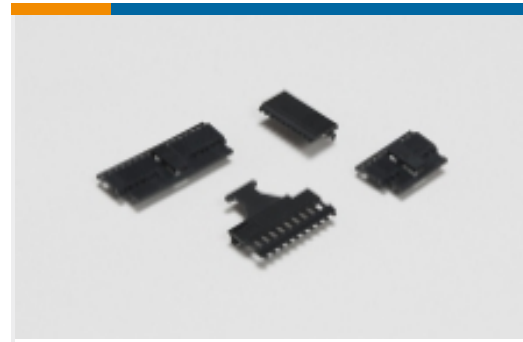

PCB Connector Covers(88)



PCB Connector Keying(2)



PCB Connector Mounting(1)

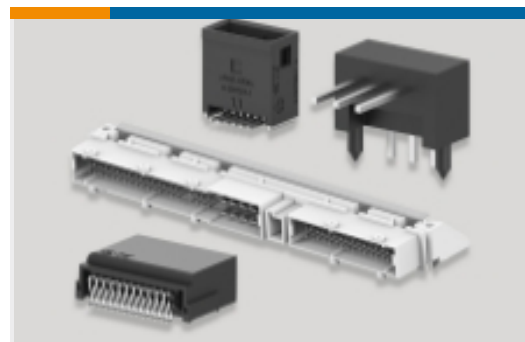

PCB Headers & Receptacles(314)

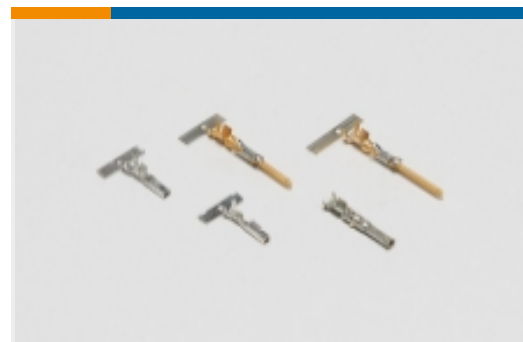

Power Contacts(2)



Rectangular Power Connectors(698)



Standard Rectangular Connectors(337)



Wire-to-Board Connector Contacts(2)

Customers Also Bought



TE Part #52410
PIDG SP SPD 22-16COMM22-18MIL8



TE Part #640384-3
03P MTA156 HDR ASSY STR RND SN



TE Part #1-640388-2
12P MTA156 HDR ASSY RN STR F/L

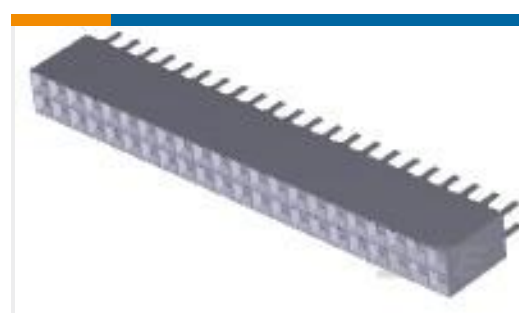

TE Part #7-534206-2
44 MODII VRT DR CE 100/115

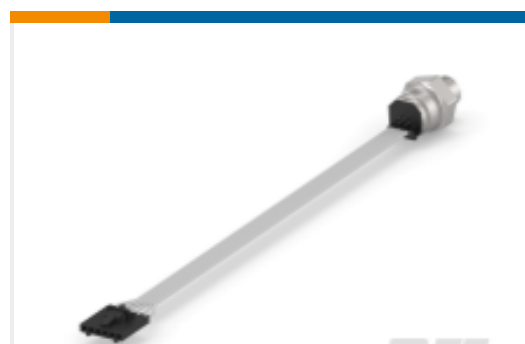

TE Part #87N-3000A-8C
3000PSIA MV PRESSURE SENSOR 1/8NPT CONNE

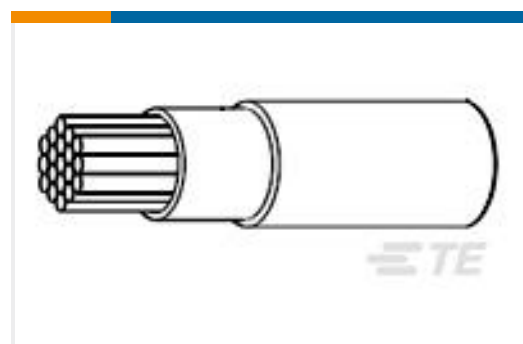

TE Part #9009933004
FLDWC0311-0.75-0



TE Part #1SNK510030R0000
ZS16-OR



TE Part #GAG10K3D128
PRO2-PROBE



Documents

Product Drawings

[08P MTA156 HDR ASSY RN STR F/L](#)

English

CAD Files

Customer View Model

[ENG_CVM_CVM_640388-8_AD.2d_dxf.zip](#)

English

3D PDF

3D

Customer View Model

[ENG_CVM_CVM_640388-8_AD.3d_igs.zip](#)

English

Customer View Model

[ENG_CVM_CVM_640388-8_AD.3d_stp.zip](#)

English

By downloading the CAD file I accept and agree to the [Terms and Conditions](#) of use.

Product Specifications

[Application Specification](#)

English

Product Environmental Compliance

[Product Compliance Document](#)

English

[Product Compliance Document](#)

English

[TE Material Declaration](#)

English

Agency Approvals

[UL Report](#)

English