

## SL-156

TE Internal #: 640254-1

PCB Connector Keying, Keying Plug, -55 – 105 °C [-67 – 221 °F], SL-156

[View on TE.com >](#)

Connectors &gt; PCB Connectors &gt; PCB Connector Accessories &gt; PCB Connector Keying

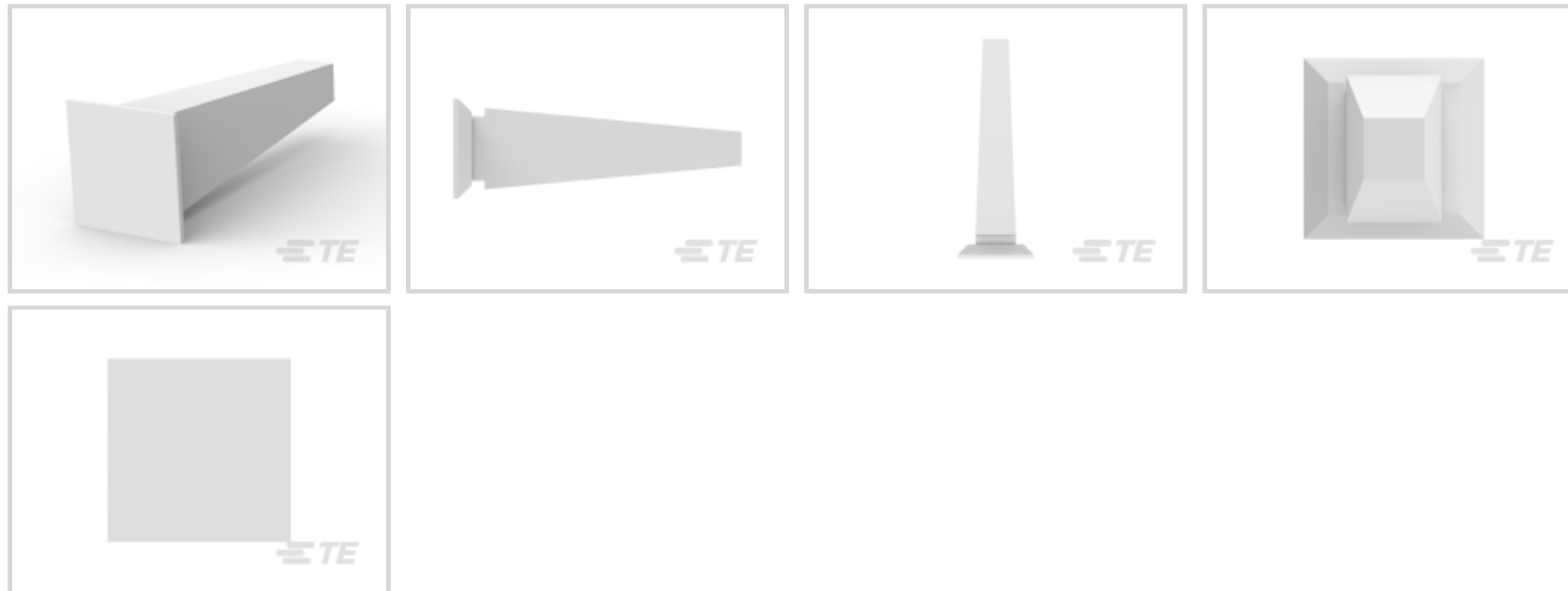
Connector Keying Accessory Type: **Keying Plug**

Operating Temperature Range: -55 – 105 °C [-67 – 221 °F]

## Features

### Product Type Features

Connector Keying Accessory Type	Keying Plug
---------------------------------	-------------

### Body Features

Primary Product Material	Nylon 6/6
Primary Product Color	Natural

### Usage Conditions

Operating Temperature Range	-55 – 105 °C [-67 – 221 °F]
-----------------------------	-----------------------------

### Industry Standards

UL Flammability Rating	UL 94V-2
------------------------	----------

### Packaging Features

Packaging Quantity	2500
Packaging Method	Bag

### Other

Connector Accessory Comment	Used with keyed headers.
-----------------------------	--------------------------

## Product Compliance

[For compliance documentation, visit the product page on TE.com>](#)

EU RoHS Directive 2011/65/EU	Compliant
EU ELV Directive 2000/53/EC	Compliant
China RoHS 2 Directive MIIT Order No 32, 2016	No Restricted Materials Above Threshold
EU REACH Regulation (EC) No. 1907/2006	Current ECHA Candidate List: JUNE 2023 (235) Candidate List Declared Against: JUNE 2023 (235) Does not contain REACH SVHC
Halogen Content	Low Halogen - Br, Cl, F, I < 900 ppm per homogenous material. Also BFR/CFR/PVC Free
Solder Process Capability	Not applicable for solder process capability

#### Product Compliance Disclaimer

This information is provided based on reasonable inquiry of our suppliers and represents our current actual knowledge based on the information they provided. This information is subject to change. The part numbers that TE has identified as EU RoHS compliant have a maximum concentration of 0.1% by weight in homogenous materials for lead, hexavalent chromium, mercury, PBB, PBDE, DBP, BBP, DEHP, DIBP, and 0.01% for cadmium, or qualify for an exemption to these limits as defined in the Annexes of Directive 2011/65/EU (RoHS2). Finished electrical and electronic equipment products will be CE marked as required by Directive 2011/65/EU. Components may not be CE marked. Additionally, the part numbers that TE has identified as EU ELV compliant have a maximum concentration of 0.1% by weight in homogenous materials for lead, hexavalent chromium, and mercury, and 0.01% for cadmium, or qualify for an exemption to these limits as defined in the Annexes of Directive 2000/53/EC (ELV). Regarding the REACH Regulation, the information TE provides on SVHC in articles for this part number is based on the latest European Chemicals Agency (ECHA) 'Guidance on requirements for substances in articles' posted at this URL: <https://echa.europa.eu/guidance-documents/guidance-on-reach>

## Compatible Parts

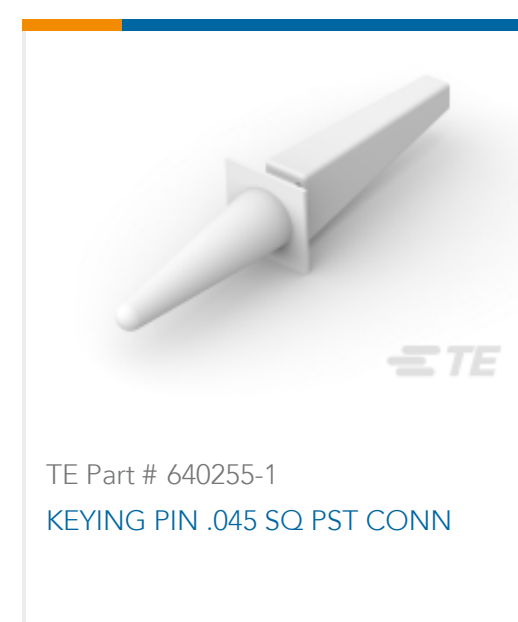
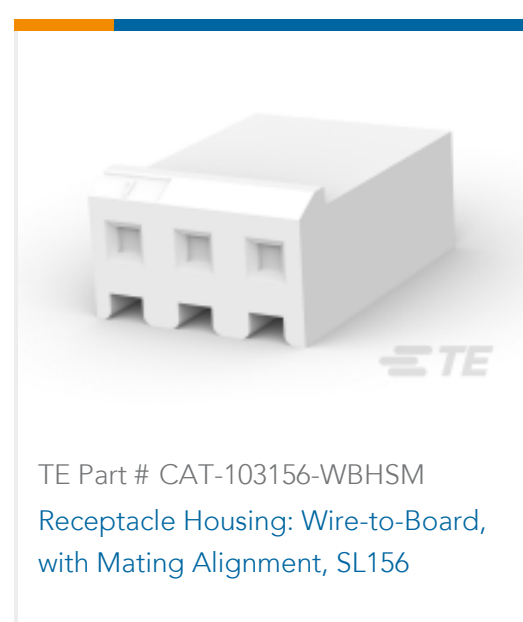

Also in the Series | **SL-156**



Insertion & Extraction Tools(1)



PCB Connector Keying(2)

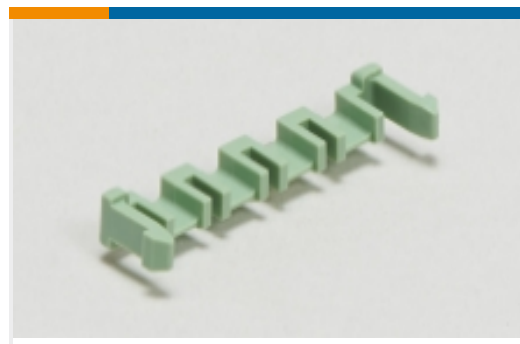

PCB Latches, Locks & Retainers(1)



Rectangular Connector Housings(11)

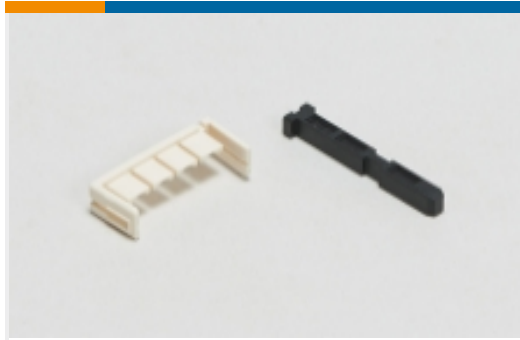

Rectangular Connector Keying Plugs(1)



Wire-to-Board Connector Assemblies & Housings(140)



Wire-to-Board Connector Contacts(23)

## Customers Also Bought

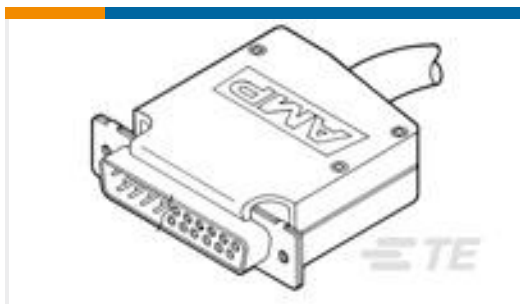

TE Part #5205732-1  
CLAMSHELL ASSEMBLY,SIZE 5



TE Part #3-643819-6  
06P MTA156 CONN ASSY 22AWG RED



TE Part #926298-7  
UNIVERSAL MATE-N-LOK 4 WAY PLUG



TE Part #1745083-1  
3 POS. PLUG ASSY AMP SUPERSEAL 1.5 SRS

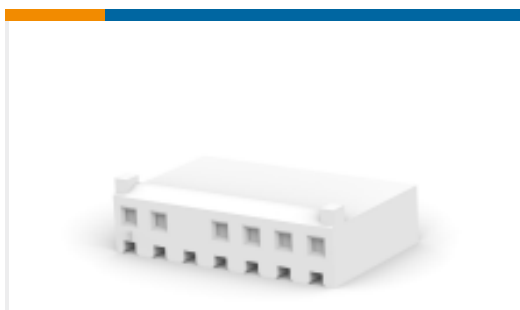

TE Part #647344-7  
07P SL156 HSG W/RP TB BLK #3



TE Part #8134334001  
CGPT-39/13-0-SP



TE Part #1879980-1  
MINI SUPERSEAL CONNECTOR



TE Part #41346  
RING TERMINAL 18-14 AWG NPSTL

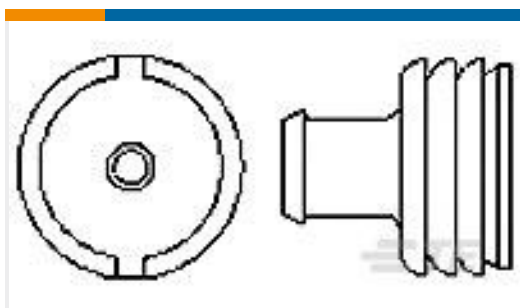

TE Part #967610-1  
MPQ EINZELLEITDICHT

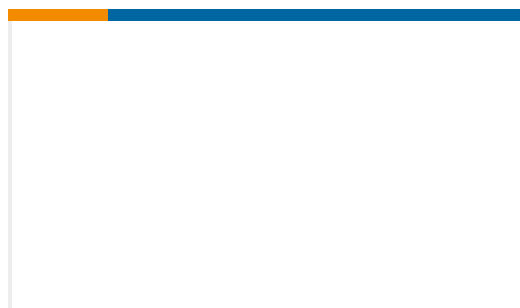

TE Part #520935-9  
PL&STANDARD FASTON 250 HOUSING REC BLA

## Documents



## Product Drawings

### KEYING PLUG .045 SQ PST CONN

English

---

## CAD Files

### 3D PDF

3D

#### Customer View Model

[ENG\\_CVM\\_CVM\\_640254-1\\_K\\_c-640254-1-k.2d\\_dxf.zip](#)

English

#### Customer View Model

[ENG\\_CVM\\_CVM\\_640254-1\\_K\\_c-640254-1-k.3d\\_igs.zip](#)

English

#### Customer View Model

[ENG\\_CVM\\_CVM\\_640254-1\\_K\\_c-640254-1-k.3d\\_stp.zip](#)

English

By downloading the CAD file I accept and agree to the [Terms and Conditions](#) of use.

---

## Product Specifications

### Application Specification

English

### Application Specification

Japanese

### Application Specification

English

### MTA 156 Ribbon Cable Connector Assemblies (English And Spanish)

English

### MTA 156 Ribbon Cable Connector Assemblies (English And Spanish)

Japanese

---

## Product Environmental Compliance

### MD\_640254-1\_1004201819\_dmtec

English

### MD\_640254-1\_1004201819\_dmtec

English

---

## Agency Approvals

### CSA Certificate

English