

63659-1 ✓ ACTIVE

MAG-MATE

TE Internal #: 63659-1

Magnet Wire Terminals, Solder Post, Mating Tab Width .05 in [1.27 mm], Size 2, 24 – 22 AWG Aluminum Wire, .51 – .64 mm Aluminum Wire, MAG-MATE

[View on TE.com >](#)



Terminals & Splices > Magnet Wire Terminals

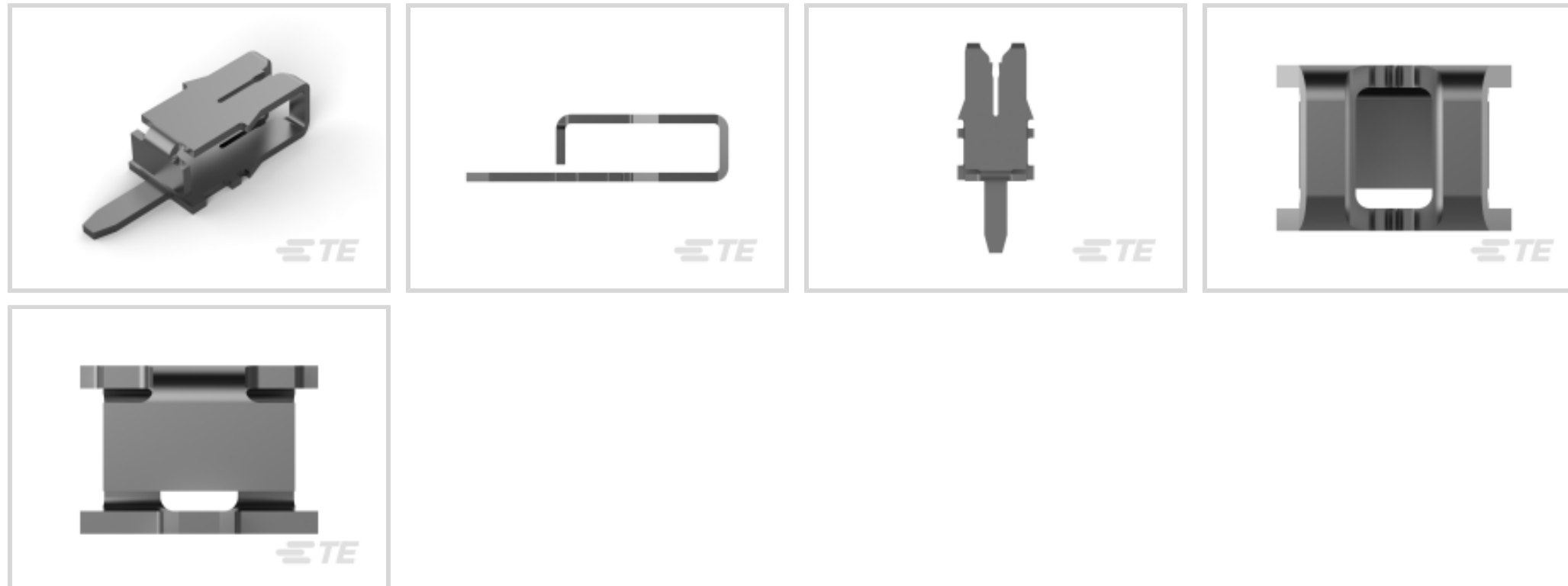

Magnet Wire Terminal Type: **Solder Post**

Mating Tab Width: **1.27 mm [.05 in]**

Mating Tab Thickness: **.55 mm [.021 in]**

Compatible With Cavity Size: **Size 2**

Aluminum Wire Size: **24 – 22 AWG**

Features

Product Type Features

Compatible With Discrete Wire Type	Magnet Wire, Solid
------------------------------------	--------------------

Body Features

Compatible With Cavity Size	Size 2
-----------------------------	--------

Contact Features

Magnet Wire Terminal Type	Solder Post
Mating Tab Width	1.27 mm [.05 in]
Mating Tab Thickness	.55 mm [.021 in]
Terminal Plating Material	Tin
Contact Underplating Material	Nickel
Terminal Orientation	Straight

Termination Features

Termination Method to Wire & Cable	Insulation Displacement (IDC)
------------------------------------	-------------------------------

Mechanical Attachment



Mating Retention Type	Dimple
-----------------------	--------

Dimensions

Terminal Height	7.68 mm[.3 in]
Aluminum Wire Size	.51 – .64 mm
Magnet Wire Size	.36 – .57 mm
Stock Thickness (Magnet Wire Side)	.41 mm[.016 in]
Product Length	11.68 mm[.46 in]

Usage Conditions

Insulation Option	Uninsulated
Operating Temperature Range	-65 – 150 °C[-85 – 302 °F]

Operation/Application

Compatible With Wire Base Material	Aluminum, Copper
------------------------------------	------------------

Identification Marking

Identification Number	10
-----------------------	----

Packaging Features

Packaging Quantity	13000
Packaging Method	Reel, Reel/Carton

Other

Terminals & Splices Comment	PC Board hole size 1.27 [.050]., Two magnet wires may be terminated in the same terminal slot if diameters are equal.
-----------------------------	---

Product Compliance

[For compliance documentation, visit the product page on TE.com>](#)

EU RoHS Directive 2011/65/EU	Compliant
EU ELV Directive 2000/53/EC	Compliant
China RoHS 2 Directive MIIT Order No 32, 2016	No Restricted Materials Above Threshold
EU REACH Regulation (EC) No. 1907/2006	Current ECHA Candidate List: JUNE 2023 (235) Candidate List Declared Against: JUNE 2023 (235) Does not contain REACH SVHC
Halogen Content	Low Halogen - Br, Cl, F, I < 900 ppm per homogenous material. Also BFR/CFR/PVC Free

Solder Process Capability

Pin-in-Paste capable to 260°C

Product Compliance Disclaimer

This information is provided based on reasonable inquiry of our suppliers and represents our current actual knowledge based on the information they provided. This information is subject to change. The part numbers that TE has identified as EU RoHS compliant have a maximum concentration of 0.1% by weight in homogenous materials for lead, hexavalent chromium, mercury, PBB, PBDE, DBP, BBP, DEHP, DIBP, and 0.01% for cadmium, or qualify for an exemption to these limits as defined in the Annexes of Directive 2011/65/EU (RoHS2). Finished electrical and electronic equipment products will be CE marked as required by Directive 2011/65/EU. Components may not be CE marked. Additionally, the part numbers that TE has identified as EU ELV compliant have a maximum concentration of 0.1% by weight in homogenous materials for lead, hexavalent chromium, and mercury, and 0.01% for cadmium, or qualify for an exemption to these limits as defined in the Annexes of Directive 2000/53/EC (ELV). Regarding the REACH Regulation, the information TE provides on SVHC in articles for this part number is based on the latest European Chemicals Agency (ECHA) 'Guidance on requirements for substances in articles' posted at this URL: <https://echa.europa.eu/guidance-documents/guidance-on-reach>

Compatible Parts

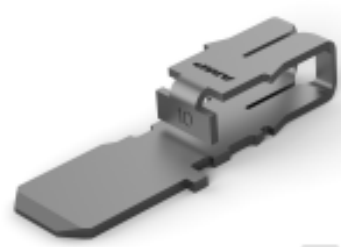

TE Part # 62514-1
MAG-MATE 27-23 187 F TAB TPBR



TE Part # 62514-2
MAG-MATE 27-23 187 F TAB TPBR

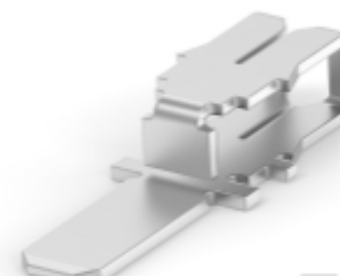

TE Part # 63973-1
MAG-MATE 118 TAB TPBR

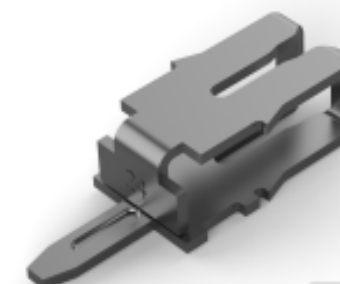

TE Part # 63661-1
MAG-MATE POST 19-17 016TPCUBR



TE Part # 63044-1
MAG-MATE TERM 27-23 016 TPBR



TE Part # 63827-1
TERMINAL, MAG-MATE F-TAB TPBR



TE Part # 2825438-1
MAG-MATE POST 27-23 016TPNIBR



TE Part # 62842-1
MAG-MATE TERM 23-26 016 TPBR



TE Part # 63461-1
MAG-MATE 187 F TAB 27-23 TPBR



TE Part # 63754-1
TERM, MAG-MATE 27-23 016TPBR

Also in the Series | **MAG-MATE**



Insertion & Extraction Tools(6)



Magnet Wire Terminals(435)



PCB Terminals(1)

Customers Also Bought

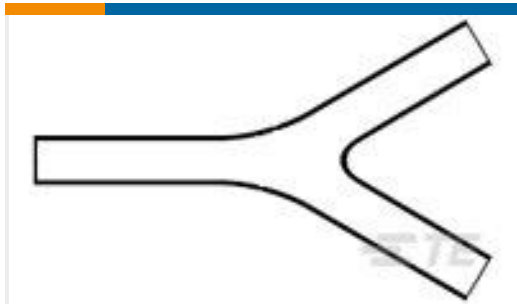
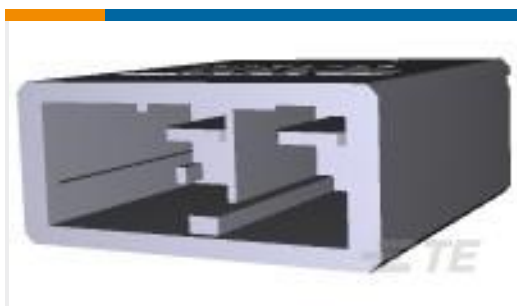
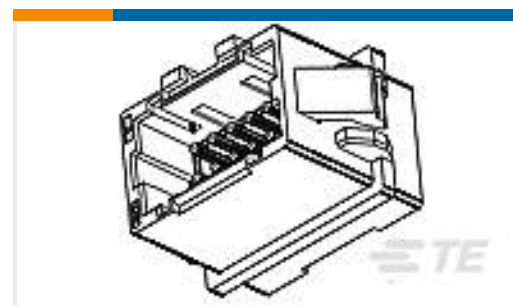
TE Part #820182-000
381A301-71-0TE Part #2-353294-6
AMP MINI D/R HDR HSG 26P NATUTE Part #1-179316-2
HYBRID MINI DRAWER REC CONT.TE Part #1445715-5
75A HSG SUBASY REDTE Part #6-353080-2
D5 V-HDR ASSY 2P TAIL LENGTH 4TE Part #2-173983-7
AMP CT MT AMP-IN HDR-H YEL 7PTE Part #4-292216-0
MINI CT D/R RELAY 40P V NATTE Part #62895-1
MAG-MATE POKE-IN TAB 018 TPBRTE Part #2329186-1
HM-EZD+, 2PAIRS, 10COLS, VERTICAL,
ASSEMBLY

Documents

CAD Files

[3D PDF](#)

[3D](#)

Customer View Model

[ENG_CVM_CVM_63659-1_J.2d_dxf.zip](#)

English

Customer View Model

[ENG_CVM_CVM_63659-1_J.3d_igs.zip](#)



English

Customer View Model

[ENG_CVM_CVM_63659-1_J.3d_stp.zip](#)

English

By downloading the CAD file I accept and agree to the [Terms and Conditions](#) of use.

Datasheets & Catalog Pages

[Magnet Wire Terminals & Splices](#)

English

Product Specifications

[Application Specification](#)

English

Product Environmental Compliance

[TE Material Declaration](#)

English