

63564-1 ✓ ACTIVE

AMPLIVAR

TE Internal #: 63564-1

Splices, Thru Splice, 17 – 12.5 AWG Wire Size, 1 – 2.8 mm² Wire Size, Splice Capacity 3, Serrated, 2000 – 5400 CMA Wire Size, Brass, AMPLIVAR

[View on TE.com >](#)



Terminals & Splices > Splices



Wire Size: 1 – 2.8 mm²

Sealable: No

Splice Capacity: 3

Splice Features: Serrated

Features

Product Type Features

Sealable	No
Splice Type	Thru Splice
Compatible With Discrete Wire Type	Magnet Wire, Solid

Configuration Features

Strip Orientation	Side Feed
Splice Capacity	3
Number of Serrations	5

Electrical Characteristics

Operating Voltage	250 V
-------------------	-------

Body Features

Product Weight	.208 g
Splice Features	Serrated

Contact Features

Terminal Plating Material	Unplated
---------------------------	----------



Contact Base Material	Brass
-----------------------	-------

Barrel Type	Open
-------------	------

Termination Features

Crimp Width	5.08 mm[.2 in]
-------------	----------------

Mechanical Attachment

Wire Insulation Support	Without
-------------------------	---------

Dimensions

Wire Size	2000 – 5400 CMA
-----------	-----------------

Terminal Material Thickness	.51 mm[.02 in]
-----------------------------	----------------

Product Length	5.97 mm[.235 in]
----------------	------------------

Usage Conditions

Insulation Option	Uninsulated
-------------------	-------------

Operating Temperature Range	-65 – 150 °C[-85 – 302 °F]
-----------------------------	----------------------------

Operation/Application

Compatible With Wire Base Material	Copper
------------------------------------	--------

Industry Standards

Government Qualified Splice	No
-----------------------------	----

Packaging Features

Packaging Quantity	5000
--------------------	------

Packaging Method	Strip
------------------	-------

Product Compliance

[For compliance documentation, visit the product page on TE.com>](#)

EU RoHS Directive 2011/65/EU	Compliant
------------------------------	-----------

EU ELV Directive 2000/53/EC	Compliant
-----------------------------	-----------

China RoHS 2 Directive MIIT Order No 32, 2016	No Restricted Materials Above Threshold
---	---

EU REACH Regulation (EC) No. 1907/2006	Current ECHA Candidate List: JUNE 2023 (235) Candidate List Declared Against: JUNE 2023 (235) Does not contain REACH SVHC
--	---

Halogen Content	Low Halogen - Br, Cl, F, I < 900 ppm per homogenous material. Also BFR/CFR/PVC Free
-----------------	---

Solder Process Capability

Not applicable for solder process capability

Product Compliance Disclaimer

This information is provided based on reasonable inquiry of our suppliers and represents our current actual knowledge based on the information they provided. This information is subject to change. The part numbers that TE has identified as EU RoHS compliant have a maximum concentration of 0.1% by weight in homogenous materials for lead, hexavalent chromium, mercury, PBB, PBDE, DBP, BBP, DEHP, DIBP, and 0.01% for cadmium, or qualify for an exemption to these limits as defined in the Annexes of Directive 2011/65/EU (RoHS2). Finished electrical and electronic equipment products will be CE marked as required by Directive 2011/65/EU. Components may not be CE marked. Additionally, the part numbers that TE has identified as EU ELV compliant have a maximum concentration of 0.1% by weight in homogenous materials for lead, hexavalent chromium, and mercury, and 0.01% for cadmium, or qualify for an exemption to these limits as defined in the Annexes of Directive 2000/53/EC (ELV). Regarding the REACH Regulation, the information TE provides on SVHC in articles for this part number is based on the latest European Chemicals Agency (ECHA) 'Guidance on requirements for substances in articles' posted at this URL: <https://echa.europa.eu/guidance-documents/guidance-on-reach>

Compatible Parts

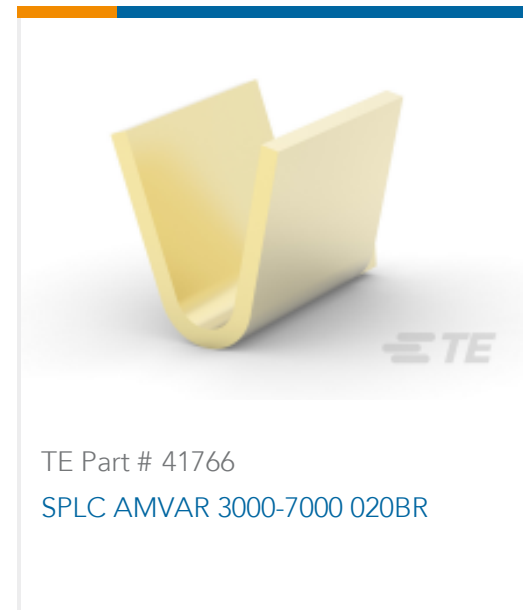
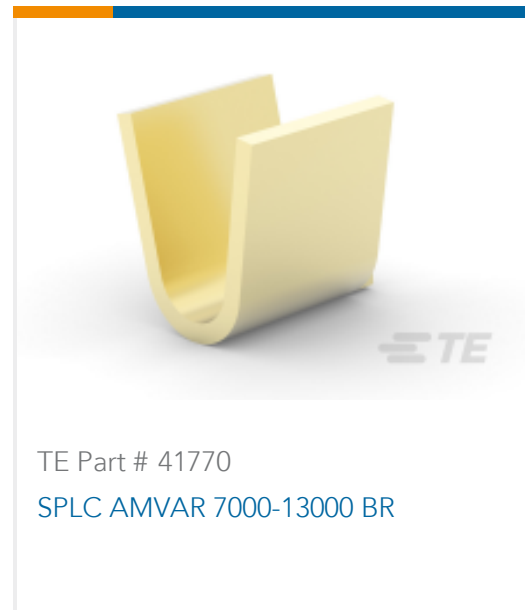

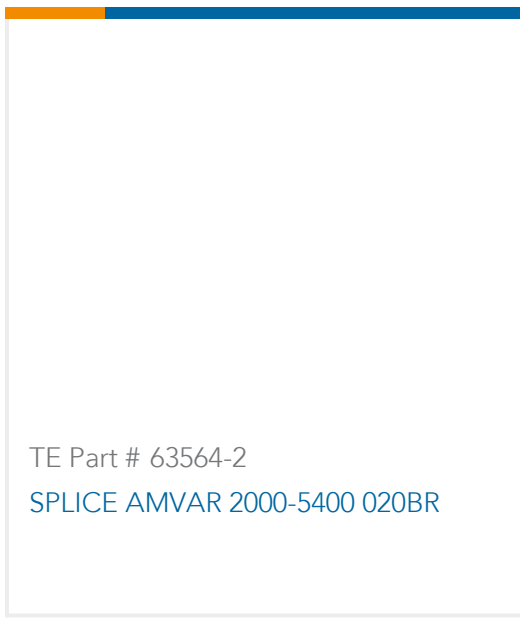

Also in the Series | AMPLIVAR

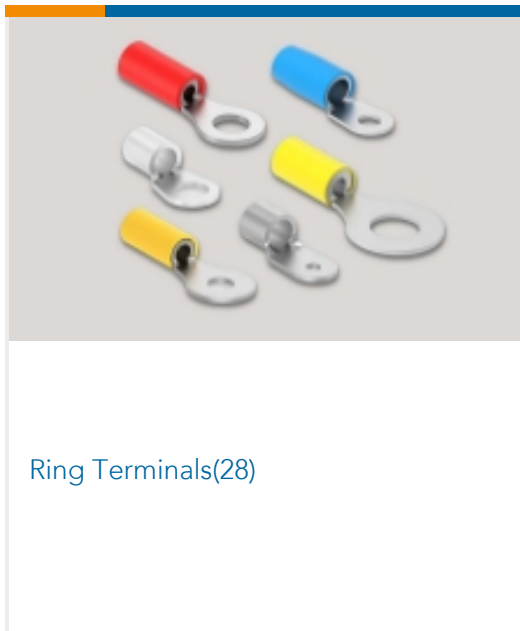
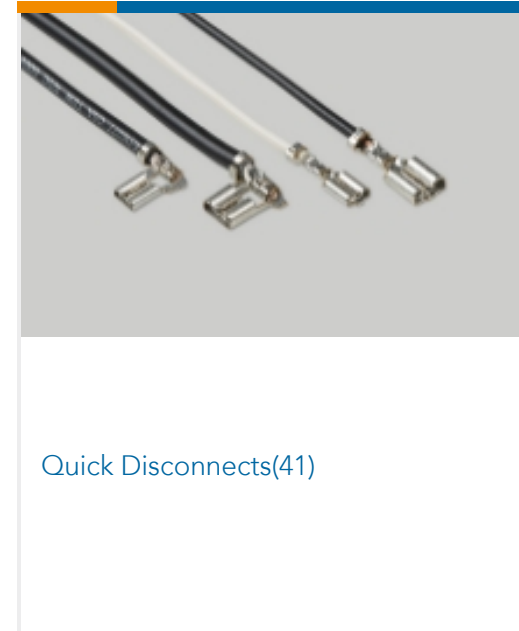
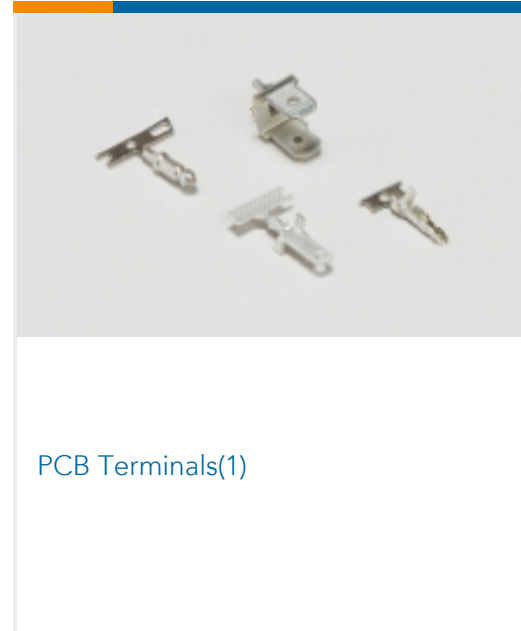

Customers Also Bought

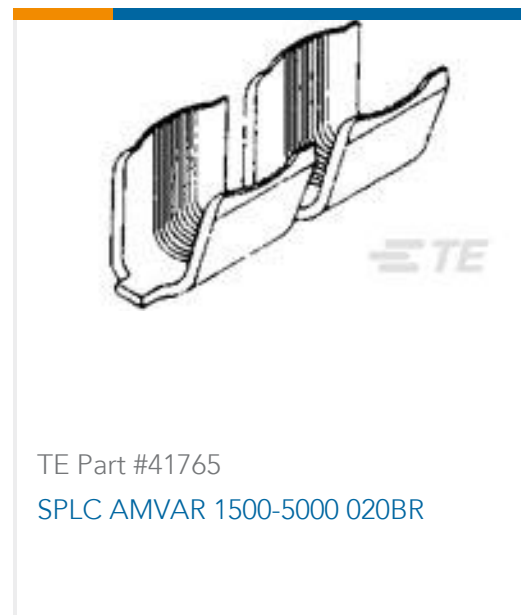



Documents

Product Drawings

[SPLICE AMVAR 2000-5400 020BR](#)

English

CAD Files

[3D PDF](#)

3D

Customer View Model

[ENG_CVM_CVM_63564-1_F.2d_dxf.zip](#)

English

Customer View Model

[ENG_CVM_CVM_63564-1_F.3d_igs.zip](#)

English

Customer View Model

[ENG_CVM_CVM_63564-1_F.3d_stp.zip](#)

English

By downloading the CAD file I accept and agree to the [Terms and Conditions](#) of use.

Datasheets & Catalog Pages

[Magnet Wire Terminals & Splices](#)

English

Product Specifications

[Application Specification](#)

English

[AMPLIVAR 5 Serration Thru Splice](#)

English

Product Environmental Compliance

[MD_63564-1_12282017735_dmtec](#)

English

[MD_63564-1_12282017735_dmtec](#)

English