

63561-1 ✓ ACTIVE

AMPLIVAR

TE Internal #: 63561-1

Splices, Thru Splice, 10 – 8 AWG Wire Size, 5 – 8 mm² Wire Size, Splice Capacity 3, Serrated, 10000 – 16000 CMA Wire Size, Brass, AMPLIVAR

[View on TE.com >](#)



Terminals & Splices > Splices

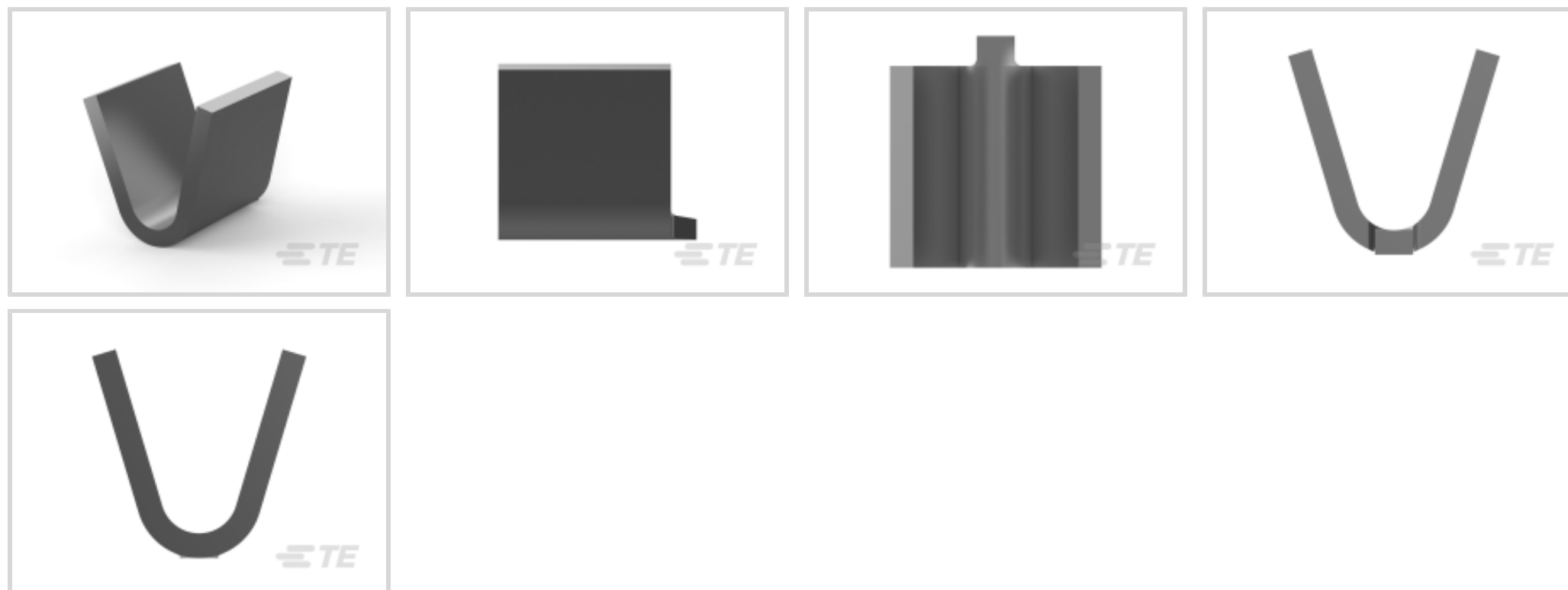

Wire Size: 5 – 8 mm²

Sealable: No

Splice Capacity: 3

Splice Features: Serrated

Features

Product Type Features

Sealable	No
Splice Type	Thru Splice
Compatible With Discrete Wire Type	Magnet Wire, Solid

Configuration Features

Strip Orientation	Side Feed
Splice Capacity	3
Number of Serrations	5

Electrical Characteristics

Operating Voltage	250 V
-------------------	-------

Body Features

Product Weight	.586 g
Splice Features	Serrated

Contact Features

Terminal Plating Material	Tin
---------------------------	-----



Contact Base Material	Brass
-----------------------	-------

Barrel Type	Open
-------------	------

Termination Features

Crimp Width	4.57 mm[.18 in]
-------------	-----------------

Mechanical Attachment

Wire Insulation Support	Without
-------------------------	---------

Dimensions

Wire Size	10000 – 16000 CMA
-----------	-------------------

Terminal Material Thickness	.8 mm[.032 in]
-----------------------------	----------------

Product Length	6.78 mm[.267 in]
----------------	------------------

Usage Conditions

Insulation Option	Uninsulated
-------------------	-------------

Operating Temperature Range	-65 – 150 °C[-85 – 302 °F]
-----------------------------	----------------------------

Operation/Application

Compatible With Wire Base Material	Copper
------------------------------------	--------

Industry Standards

Government Qualified Splice	No
-----------------------------	----

Packaging Features

Packaging Quantity	2000
--------------------	------

Packaging Method	Strip
------------------	-------

Product Compliance

[For compliance documentation, visit the product page on TE.com>](#)

EU RoHS Directive 2011/65/EU	Compliant
------------------------------	-----------

EU ELV Directive 2000/53/EC	Compliant
-----------------------------	-----------

China RoHS 2 Directive MIIT Order No 32, 2016	No Restricted Materials Above Threshold
---	---

EU REACH Regulation (EC) No. 1907/2006	Current ECHA Candidate List: JUNE 2023 (235) Candidate List Declared Against: JUNE 2023 (235) Does not contain REACH SVHC
--	---

Halogen Content	Low Halogen - Br, Cl, F, I < 900 ppm per homogenous material. Also BFR/CFR/PVC Free
-----------------	---

Solder Process Capability

Not applicable for solder process capability

Product Compliance Disclaimer

This information is provided based on reasonable inquiry of our suppliers and represents our current actual knowledge based on the information they provided. This information is subject to change. The part numbers that TE has identified as EU RoHS compliant have a maximum concentration of 0.1% by weight in homogenous materials for lead, hexavalent chromium, mercury, PBB, PBDE, DBP, BBP, DEHP, DIBP, and 0.01% for cadmium, or qualify for an exemption to these limits as defined in the Annexes of Directive 2011/65/EU (RoHS2). Finished electrical and electronic equipment products will be CE marked as required by Directive 2011/65/EU. Components may not be CE marked. Additionally, the part numbers that TE has identified as EU ELV compliant have a maximum concentration of 0.1% by weight in homogenous materials for lead, hexavalent chromium, and mercury, and 0.01% for cadmium, or qualify for an exemption to these limits as defined in the Annexes of Directive 2000/53/EC (ELV). Regarding the REACH Regulation, the information TE provides on SVHC in articles for this part number is based on the latest European Chemicals Agency (ECHA) 'Guidance on requirements for substances in articles' posted at this URL: <https://echa.europa.eu/guidance-documents/guidance-on-reach>

Compatible Parts



TE Part # 63562-1
SPLICE 10400-22900 030TPBR



TE Part # 63621-2
SPLICE S-MINI/AMVAR 0098TPCUBR



TE Part # 2-2266950-1
OCEAN-2.0-APPLICATOR-S-180F



TE Part # 2-2266950-2
OCEAN-2.0-APPLICATOR-S-180F



TE Part # 2266950-1
OCEAN-2.0-APPLICATOR-S-180F



TE Part # 2266950-2
OCEAN-2.0-APPLICATOR-S-180F



TE Part # 7-2266950-7
OCEAN_2.0_SPARE_PART_KIT-180F

Also in the Series | AMPLIVAR



Crimp Wire Pins, Tabs & Ferrules(5)



Magnet Wire Terminals(4)



PCB Terminals(1)



Quick Disconnects(41)



Ring Terminals(28)



Splices(77)

Customers Also Bought

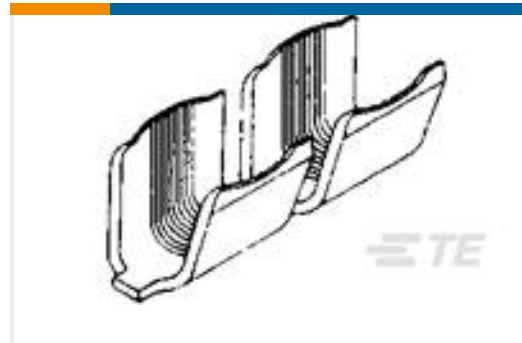
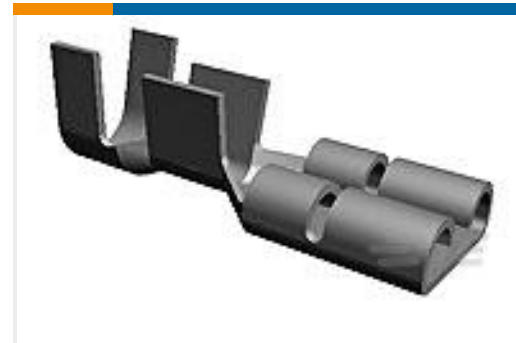
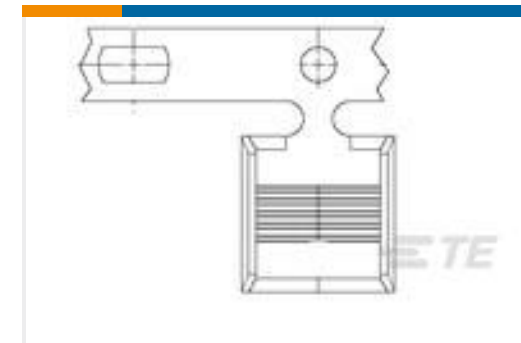
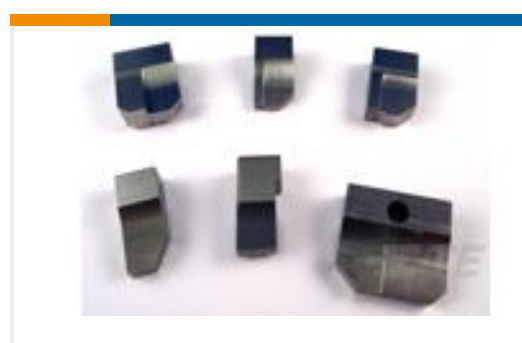
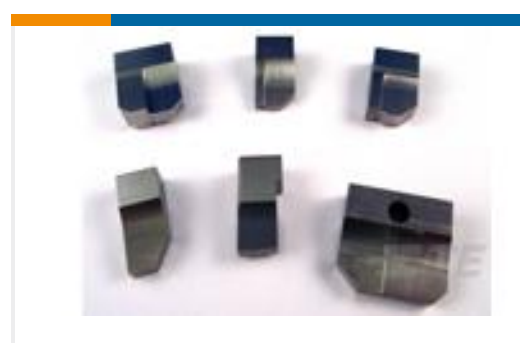
TE Part #41770
SPLC AMVAR 7000-13000 BRTE Part #61299-3
SPLICE 7000-12500 .031 BRTE Part #63475-2
187 FASTON REC 20-16 AWG TPBRTE Part #41450
250 FASTON REC 14-10 AWG TPBRTE Part #63130-2
SPLICE REC. 1500-5000 .020 BRTE Part #2-2138650-1
2POS MQS REC COD BTE Part #5-928999-6
MQS0,63 Ag rec LL unseal. >0,2-0,35TE Part #1217990-2
AMVAR SPLC 6000-14000 025TPBRTE Part #1-1338690-1
ANVIL, COMBINATION .055TE Part #5-805887-3
ANVIL, COMBINATION

Documents

Product Drawings

[SPLICE 10000-16000 CMA 031BR](#)

English

CAD Files

[3D PDF](#)

[3D](#)

[Customer View Model](#)

[ENG_CVM_CVM_63561-1_K.2d_dxf.zip](#)



English

Customer View Model

[ENG_CVM_CVM_63561-1_K.3d_igs.zip](#)

English

Customer View Model

[ENG_CVM_CVM_63561-1_K.3d_stp.zip](#)

English

By downloading the CAD file I accept and agree to the [Terms and Conditions](#) of use.

Datasheets & Catalog Pages

[1654742_HOUSEHOLD_APPLIANCES_RAST5](#)

English

Magnet Wire Terminals & Splices

English

Product Specifications

[Application Specification](#)

English

[AMPLIVAR 5 Serration Thru Splice](#)

English

Product Environmental Compliance

[Product Compliance](#)

English

[Product Compliance](#)

English