

62780-1 ✓ ACTIVE

MAG-MATE

TE Internal #: 62780-1

Magnet Wire Terminals, Poke-In, Mating Tab Width .253 in [6.43 mm], Special, Lead Wire Size 22 – 18 AWG, Lead Wire Size .3 – .9 mm², MAG-MATE

[View on TE.com >](#)



Terminals & Splices > Magnet Wire Terminals



Magnet Wire Terminal Type: **Poke-In**

Mating Tab Width: **6.43 mm [.253 in]**

Mating Tab Thickness: **.83 mm [.033 in]**

Compatible With Cavity Size: **Special**

Lead Wire Size: **22 – 18 AWG**

Features

Product Type Features

Compatible With Discrete Wire Type	Magnet Wire, Solid
------------------------------------	--------------------

Body Features

Compatible With Cavity Size	Special
-----------------------------	---------

Contact Features

Magnet Wire Terminal Type	Poke-In
Mating Tab Width	6.43 mm[.253 in]
Mating Tab Thickness	.83 mm[.033 in]
Terminal Plating Material	Tin
Terminal Orientation	Straight

Termination Features

Termination Method to Wire & Cable	Insulation Displacement (IDC)
------------------------------------	-------------------------------

Mechanical Attachment

Mating Retention Type	Dimple
-----------------------	--------



Dimensions

Terminal Height	8.76 mm[.345 in]
Lead Wire Size	.3 – .9 mm ²
Magnet Wire Size	.05 – .13 mm
Stock Thickness (Magnet Wire Side)	.25 mm[.01 in]
Product Length	8.78 mm[.345 in]

Usage Conditions

Insulation Option	Uninsulated
Operating Temperature Range	-65 – 150 °C[-85 – 302 °F]

Operation/Application

Compatible With Wire Base Material	Copper
------------------------------------	--------

Identification Marking

Identification Number	10
-----------------------	----

Packaging Features

Packaging Quantity	5000
Packaging Method	Reel, Reel/Carton

Other

Terminals & Splices Comment	Solid or overcoated stranded lead wire only.
-----------------------------	--

Product Compliance





[For compliance documentation, visit the product page on TE.com>](#)

EU RoHS Directive 2011/65/EU	Compliant
EU ELV Directive 2000/53/EC	Compliant
China RoHS 2 Directive MIIT Order No 32, 2016	No Restricted Materials Above Threshold
EU REACH Regulation (EC) No. 1907/2006	Current ECHA Candidate List: JUNE 2023 (235) Candidate List Declared Against: JUNE 2023 (235) Does not contain REACH SVHC
Halogen Content	Low Halogen - Br, Cl, F, I < 900 ppm per homogenous material. Also BFR/CFR/PVC Free
Solder Process Capability	Not applicable for solder process capability

Product Compliance Disclaimer

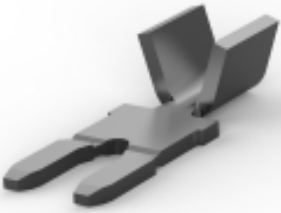
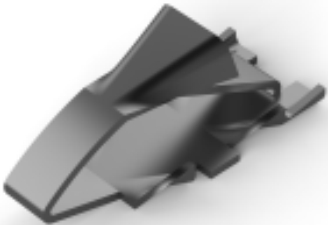
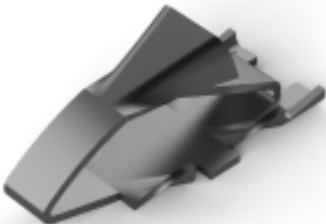
This information is provided based on reasonable inquiry of our suppliers and represents our current actual knowledge based on the information they provided. This information is subject to change. The part numbers that TE has identified as EU RoHS compliant have a maximum concentration of 0.1% by weight in homogenous materials for lead, hexavalent chromium, mercury, PBB, PBDE, DBP, BBP, DEHP, DIBP, and 0.01% for cadmium, or qualify for an exemption to these limits as defined in the Annexes of Directive 2011/65/EU (RoHS2). Finished electrical and electronic equipment products will be CE marked as required by Directive 2011/65/EU. Components may not be CE marked. Additionally, the part numbers that TE has identified as EU ELV compliant have a maximum concentration of 0.1% by weight in homogenous materials for lead, hexavalent chromium, and mercury, and 0.01% for cadmium, or qualify for an exemption to these limits as defined in the Annexes of Directive 2000/53/EC (ELV). Regarding the REACH Regulation, the information TE provides on SVHC in articles for this part number is based on the latest European Chemicals Agency (ECHA) 'Guidance on requirements for substances in articles' posted at this URL: <https://echa.europa.eu/guidance-documents/guidance-on-reach>

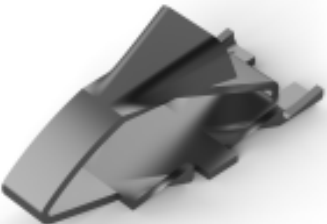
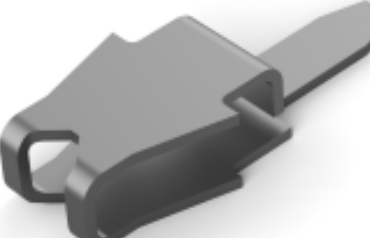
Compatible Parts

 <p>TE Part # 62897-1 MAG-MATE POKE-IN TAB 020 TPBR</p>	 <p>TE Part # 62781-1 MINI MAG-MATE 42-52 010 TPBR</p>	 <p>TE Part # 63613-1 MINI MAG-MATE 42-52 010 TPBR</p>	 <p>TE Part # 1217529-1 MINI MAG-MATE 187 TAB</p>
 <p>TE Part # 62781-3 TERM MAG-MATE MINI 42-52 TPBR</p>	 <p>TE Part # 62606-1 MINI MAG-MATE 30-38 010 TPBR</p>	 <p>TE Part # 62781-2 TERM MAG-MATE MINI 42-52 TPBR</p>	 <p>TE Part # 62938-1 MAG-MATE POST 33-31 010 TPBR</p>
 <p>TE Part # 62895-1 MAG-MATE POKE-IN TAB 018 TPBR</p>	 <p>TE Part # 1217457-1 RECEPT. TAB, MAG-MATE</p>	 <p>TE Part # 62655-1 MAG-MATE 250FTAB 32-31 010TPBR</p>	

Also in the Series | **MAG-MATE**



Insertion & Extraction Tools(6)



Magnet Wire Terminals(435)



PCB Terminals(1)

Customers Also Bought

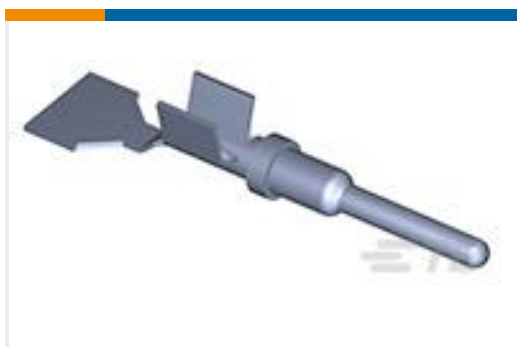
TE Part #776430-1
AMPSEAL 16 HousingsTE Part #1-1418448-1
3 POS. AMP MCP1.5k REC.HSG COTE Part #63658-1
MAG MATE TERM 25-22 016TPBRTE Part #1060-16-0144
PIN, SF, SIZE 16, 14-18, AU/SNTE Part #638112-1
PIN, SF, SIZE 16, 14-18 AWG, NO INS, AU/SNTE Part #928781-2
FF 110 TAB 1.0-2.5 MM2 PTP CUZN30TE Part #60601-1
110 FASTON REC 20-18 AWG TPBRTE Part #1-659822-0
INSERTER, SINGLETE Part #1901767-1
PLATE, DIVIDER

Documents

Product Drawings

[MINI MAG-MATE 36-44 010 TPBR](#)

English

CAD Files

[3D PDF](#)

3D

[Customer View Model](#)

[ENG_CVM_CVM_62780-1_AT.2d_dxf.zip](#)



English

Customer View Model

[ENG_CVM_CVM_62780-1_AT.3d_igs.zip](#)

English

Customer View Model

[ENG_CVM_CVM_62780-1_AT.3d_stp.zip](#)

English

By downloading the CAD file I accept and agree to the [Terms and Conditions](#) of use.

Datasheets & Catalog Pages

[Magnet Wire Terminals & Splices](#)

English

Product Specifications

[Application Specification](#)

English

Product Environmental Compliance

[Product Compliance](#)

English

[Product Compliance](#)

English