

62627-1 ✓ ACTIVE

FASTON | FASTON 250

TE Internal #: 62627-1

PCB Terminals, Tab, Mating Tab Width .25 in [6.35 mm], PCB Hole Diameter 3.68 mm [.145 in], Through Hole - Screw, Tin Plating, None, Bag, FASTON 250

[View on TE.com >](#)



Terminals & Splices > PCB Terminals



PCB Terminal Type: **Tab**

Mating Tab Width: **6.35 mm [.25 in]**

Mating Tab Thickness: **.81 mm [.032 in]**

PCB Hole Diameter: **3.68 mm [.145 in]**

Termination Method to Printed Circuit Board: **Through Hole - Screw**

Features

Product Type Features

Terminal Features	Stud Hole
Insertion Force	Normal

Contact Features

Terminal Plating Finish	Matte
PCB Contact Termination Area Plating Material Thickness	2.03 – 3.81 μm [80 – 150 μin]
Contact Mating Area Plating Material Thickness	2.03 – 3.81 μm [80 – 150 μin]
PCB Terminal Type	Tab
Mating Tab Width	6.35 mm[.25 in]
Mating Tab Thickness	.81 mm[.032 in]
Terminal Plating Material	Tin
Contact Underplating Material	None
Terminal Size	6.35
Terminal Orientation	Straight

Termination Features



Termination Method to Printed Circuit Board	Through Hole - Screw
---	----------------------

Product Terminates To	Printed Circuit Board
-----------------------	-----------------------

Dimensions

Stud Diameter	3.68 mm [.145 in]
---------------	-------------------

PCB Hole Diameter	3.68 mm [.145 in]
-------------------	-------------------

Usage Conditions

Insulation Option	Uninsulated
-------------------	-------------

Operating Temperature Range	-40 – 105 °C [-40 – 221 °F]
-----------------------------	-----------------------------

Packaging Features

Packaging Quantity	1000
--------------------	------

Packaging Method	Bag
------------------	-----

Product Compliance

[For compliance documentation, visit the product page on TE.com>](#)

EU RoHS Directive 2011/65/EU	Compliant
------------------------------	-----------

EU ELV Directive 2000/53/EC	Compliant
-----------------------------	-----------

China RoHS 2 Directive MIIT Order No 32, 2016	No Restricted Materials Above Threshold
---	---

EU REACH Regulation (EC) No. 1907/2006	Current ECHA Candidate List: JUNE 2023 (235) Candidate List Declared Against: JUNE 2023 (235) Does not contain REACH SVHC
--	---

Halogen Content	Low Halogen - Br, Cl, F, I < 900 ppm per homogenous material. Also BFR/CFR/PVC Free
-----------------	---

Solder Process Capability	Not applicable for solder process capability
---------------------------	--

Product Compliance Disclaimer

This information is provided based on reasonable inquiry of our suppliers and represents our current actual knowledge based on the information they provided. This information is subject to change. The part numbers that TE has identified as EU RoHS compliant have a maximum concentration of 0.1% by weight in homogenous materials for lead, hexavalent chromium, mercury, PBB, PBDE, DBP, BBP, DEHP, DIBP, and 0.01% for cadmium, or qualify for an exemption to these limits as defined in the Annexes of Directive 2011/65/EU (RoHS2). Finished electrical and electronic equipment products will be CE marked as required by Directive 2011/65/EU. Components may not be CE marked. Additionally, the part numbers that TE has identified as EU ELV compliant have a maximum concentration of 0.1% by weight in homogenous materials for lead, hexavalent chromium, and mercury, and 0.01% for cadmium, or qualify for an exemption to these limits as defined in the Annexes of Directive 2000/53/EC (ELV). Regarding the REACH Regulation, the information TE provides on SVHC in articles for this part number is based on the latest European Chemicals Agency (ECHA) 'Guidance on requirements for substances in articles' posted at this URL: <https://echa.europa.eu/guidance-documents/guidance-on-reach>

Compatible Parts



TE Part # 63038-1
250 FASTON TAB TPBR



TE Part # 61499-1
250 FASTON TAB TPBR



TE Part # 61365-1
250 FASTON TAB TPBR



TE Part # 62627-2
250 FASTON TAB BR



TE Part # 60920-5
187 FASTON TAB TPBR



TE Part # 60922-5
FASTON .205 SERIES (5.2 MM) TAB TPST



TE Part # 60920-1
187 FASTON TAB BR



TE Part # 1217002-1
250 FASTON,TAB, NPCST



TE Part # 63971-1
250 FASTON TAB TPBR



TE Part # 62627-3
250 FASTON TAB BR



TE Part # 140736-2
250 FASTON,TAB,TPBR



TE Part # 60921-1
205 FASTON SERIES TAB BR



TE Part # 60922-1
205 FASTON SERIES TAB BR



TE Part # 63274-3
250 FASTON TAB BR

Also in the Series | FASTON 250

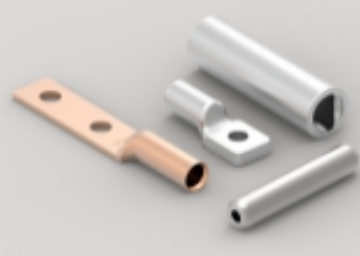

Compression Connectors(4)

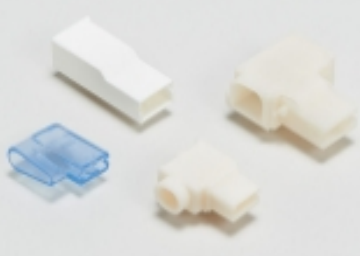

Crimp Terminal Housings(142)



Insertion & Extraction Tools(6)

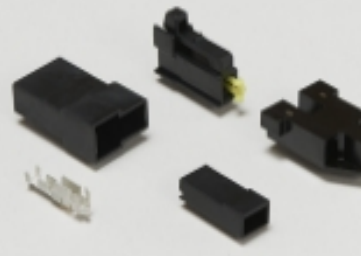

Magnet Wire Terminals(1)



PCB Terminals(135)



Quick Disconnects(445)



Splices(4)

Customers Also Bought

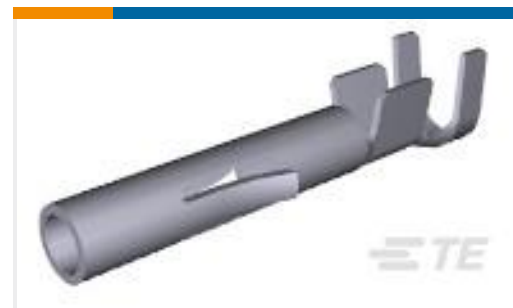
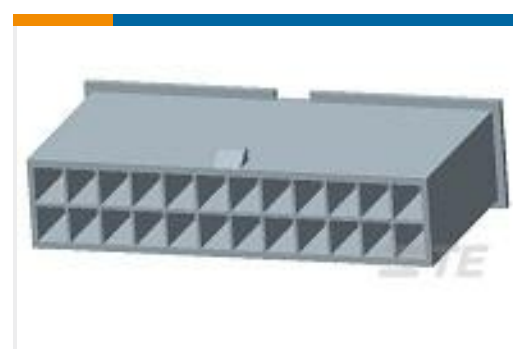
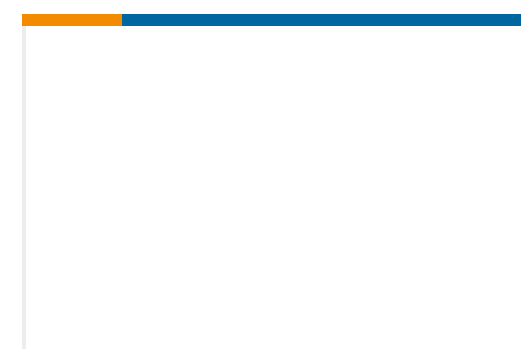
TE Part #3-647000-6
06P MTA100 PSTD CONN ASSY LFTE Part #2-520261-2
ULTRA-FAST 187 ASY REC 22-18 TPBRTE Part #350536-1
UMNL SOK 20-14 .0126 PTPBRTE Part #2825210-1
VAL-U-LOK PIN HCS SN 18-22AWGTE Part #2323101-5
PicoMQS, 2-22 POS HDR ASSY,
UnsealedTE Part #1-1904045-5
V23333Z1001B045-EV-100TE Part #1-1969612-0
10P FH PLUG VAL-U-LOK V0TE Part #538216-2
ULTRASONIC SENSORTE Part #6-1372234-3
AXIS

Documents

Product Drawings

250 FASTON TAB TPST

English

CAD Files

3D PDF

3D

Customer View Model

ENG_CVM_CVM_62627-1_P.2d_dxf.zip



English

Customer View Model

[ENG_CVM_CVM_62627-1_P.3d_igs.zip](#)

English

Customer View Model

[ENG_CVM_CVM_62627-1_P.3d_stp.zip](#)

English

By downloading the CAD file I accept and agree to the [Terms and Conditions](#) of use.

Datasheets & Catalog Pages

FASTON Tabs

English