



Terminals &amp; Splices &gt; Ring Terminals



Ring Terminal Product Type: Closed Ring Tongue Terminal

Wire Size: 2048 – 5178 CMA

Stud Size: 1/4

## Features

### Product Type Features

Terminal Features	Sheared
Shape Description	RING-001
Ring Terminal Product Type	Closed Ring Tongue Terminal
Stud Size	1/4
Sealable	No
Compatible With Discrete Wire Type	Stranded
Wire Insulation Support Retention Type	Insulation Support

### Configuration Features

Number of Holes	1
-----------------	---

### Body Features

Product Weight	.958 g
----------------	--------

### Contact Features

Barrel Type	Open
Terminal Orientation	Straight
Terminal Plating Material	Unplated

### Mechanical Attachment



Wire Insulation Support	With
-------------------------	------

### Dimensions

Wire Size	2048 – 5178 CMA
Stud Diameter	6.5 mm [.256 in]
Tongue Thickness	.6 mm [.023 in]
Product Length	19.8 mm [.779 in]
Barrel Inside Diameter	1.77 mm, 2.46 mm [.07 in] [.097 in]
Compatible Insulation Diameter (Max)	3.81 mm [.15 in]
Compatible Insulation Diameter Range	2.2 – 3.8 mm [.087 – .15 in]

### Usage Conditions

Insulation Option	Uninsulated
Operating Temperature Range	-40 – 105 °C [-40 – 221 °F]

### Operation/Application

Compatible With Wire Base Material	Copper
------------------------------------	--------

### Industry Standards

Government Qualified Terminal	No
-------------------------------	----

### Packaging Features

Packaging Quantity	5000
Packaging Method	Strip/Reel

### Other

Terminals & Splices Comment	Similar to DIN 46225.
-----------------------------	-----------------------

### Product Compliance

[For compliance documentation, visit the product page on TE.com>](#)

EU RoHS Directive 2011/65/EU	Compliant
EU ELV Directive 2000/53/EC	Compliant
China RoHS 2 Directive MIIT Order No 32, 2016	No Restricted Materials Above Threshold
EU REACH Regulation (EC) No. 1907/2006	Current ECHA Candidate List: JUNE 2023 (235) Candidate List Declared Against: JUNE 2022 (224) Does not contain REACH SVHC
Halogen Content	Low Halogen - Br, Cl, F, I < 900 ppm per homogenous material. Also BFR/CFR/PVC

Free











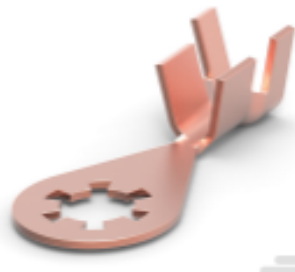

Solder Process Capability

Not applicable for solder process capability

## Product Compliance Disclaimer

This information is provided based on reasonable inquiry of our suppliers and represents our current actual knowledge based on the information they provided. This information is subject to change. The part numbers that TE has identified as EU RoHS compliant have a maximum concentration of 0.1% by weight in homogenous materials for lead, hexavalent chromium, mercury, PBB, PBDE, DBP, BBP, DEHP, DIBP, and 0.01% for cadmium, or qualify for an exemption to these limits as defined in the Annexes of Directive 2011/65/EU (RoHS2). Finished electrical and electronic equipment products will be CE marked as required by Directive 2011/65/EU. Components may not be CE marked. Additionally, the part numbers that TE has identified as EU ELV compliant have a maximum concentration of 0.1% by weight in homogenous materials for lead, hexavalent chromium, and mercury, and 0.01% for cadmium, or qualify for an exemption to these limits as defined in the Annexes of Directive 2000/53/EC (ELV). Regarding the REACH Regulation, the information TE provides on SVHC in articles for this part number is based on the latest European Chemicals Agency (ECHA) 'Guidance on requirements for substances in articles' posted at this URL: <https://echa.europa.eu/guidance-documents/guidance-on-reach>

## Compatible Parts

 <p>TE Part # 880219-4 TERMINAL</p>	 <p>TE Part # 2150020-2 OCEAN_2.0_APPLICATOR-E-130F160F</p>	 <p>TE Part # 444025-1 RING TONGUE ANTITOR</p>	 <p>TE Part # 444026-1 RING TONGUE ANTI ROTATIONAL 1-5 MM2 BR</p>
 <p>TE Part # 444026-2 RT ANTI ROTATIONAL 1-5 MM2 ELECTRO TPBR</p>	 <p>TE Part # 444151-2 RING TONGUE 2.5-4.0 MM2 0.81 ELECTROTPBR</p>	 <p>TE Part # 444155-2 RING TONGUE 1-5 MM2 0.6 ELECTRO TPBR</p>	 <p>TE Part # 626283-3 RING TONGUE ANT ROT</p>
 <p>TE Part # 7-2150020-2 OCEAN_2.0_APPLICATOR-E-130F160F</p>	 <p>TE Part # 7-2150020-7 OCEAN_2.0_SPARE_PART_KIT-130F160F</p>	 <p>TE Part # 880551-1 RING TONGUE 1.0-2.5 MM2 BR</p>	 <p>TE Part # 881000-1 RING TONGUE 2.5/4.0 MM2 BR</p>



## Customers Also Bought

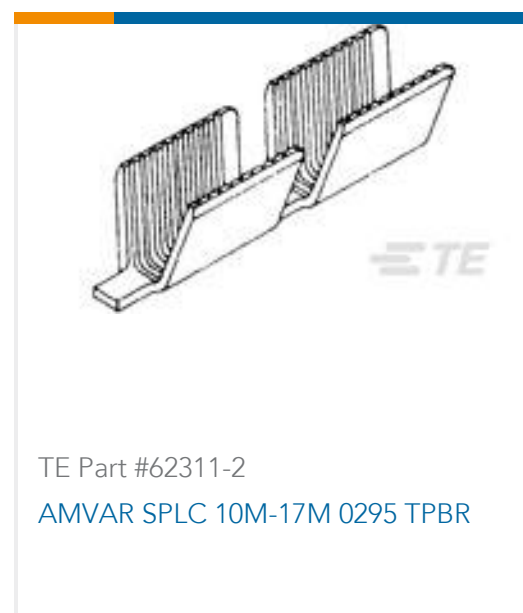

## Documents

### Product Drawings

RING TONGUE 1.0-2.5 MM2 .236 X .521 BR

English

### CAD Files

3D PDF

3D

Customer View Model

ENG\_CVM\_CVM\_626034-1\_F.2d\_dxf.zip



English

**Customer View Model**

[ENG\\_CVM\\_CVM\\_626034-1\\_F.3d\\_igs.zip](#)

English

**Customer View Model**

[ENG\\_CVM\\_CVM\\_626034-1\\_F.3d\\_stp.zip](#)

English

**Customer View Model**

[ENG\\_CVM\\_626034-1\\_E.3d\\_igs.zip](#)

English

**Customer View Model**

[ENG\\_CVM\\_626034-1\\_E.3d\\_stp.zip](#)

English

**Customer View Model**

[ENG\\_CVM\\_626034-1\\_E.2d\\_dxf.zip](#)

English

**3D PDF**

English

By downloading the CAD file I accept and agree to the [Terms and Conditions](#) of use.

**Product Specifications**

**Application Specification**

English

**Crimping Ring Tongue Terminals**

English