

62306-2 ✓ ACTIVE

## AMPLIVAR

TE Internal #: 62306-2

Splices, Pigtail Splice, 18.5 – 13.5 AWG Wire Size, .8 – 2.5 mm<sup>2</sup> Wire Size, Splice Capacity 3, Serrated, 1500 – 5000 CMA Wire Size, Brass, AMPLIVAR

[View on TE.com >](#)



Terminals & Splices > Splices

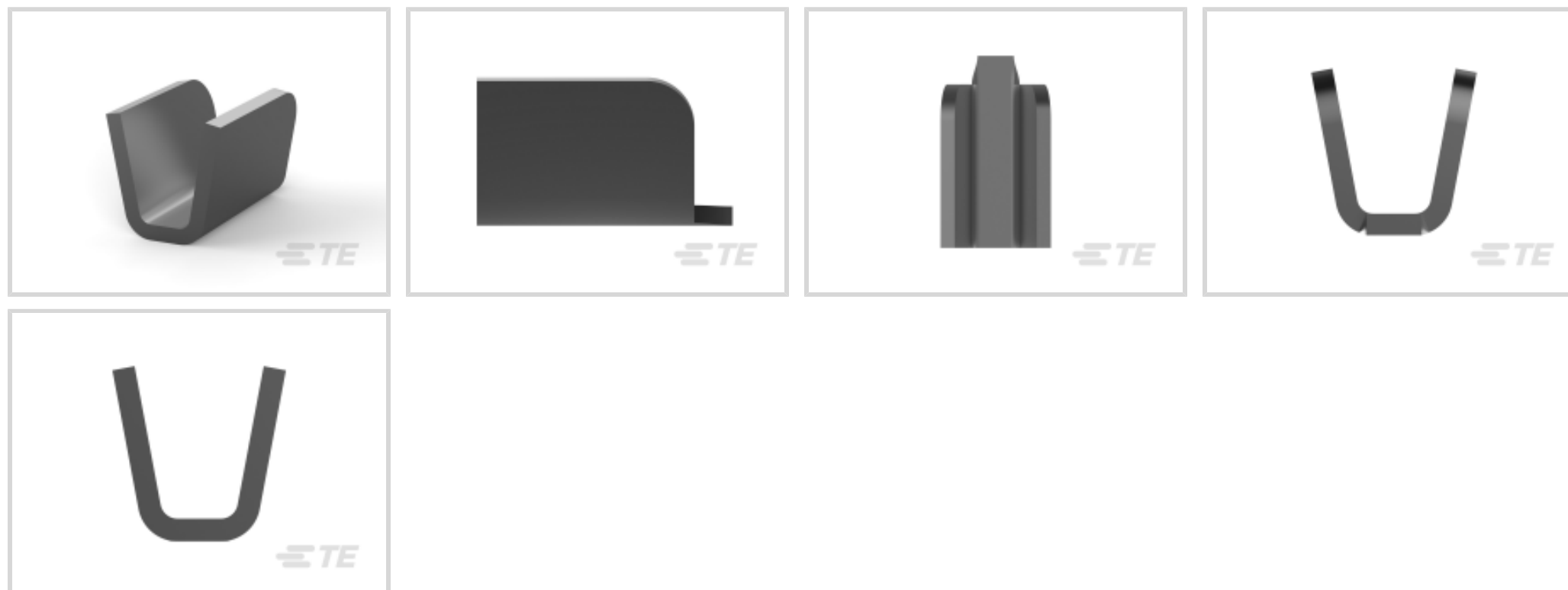

Wire Size: .8 – 2.5 mm<sup>2</sup>

Sealable: No

Splice Capacity: 3

Splice Features: **Serrated**

### Features

#### Product Type Features

Sealable	No
Splice Type	Pigtail Splice
Compatible With Discrete Wire Type	Magnet Wire, Solid

#### Configuration Features

Strip Orientation	End Feed
Splice Capacity	3
Number of Serrations	9

#### Electrical Characteristics

Operating Voltage	250 V
-------------------	-------

#### Body Features

Product Weight	.185 g
Splice Features	Serrated

#### Contact Features

Terminal Plating Material	Tin
---------------------------	-----



Contact Base Material	Brass
-----------------------	-------

Barrel Type	Open
-------------	------

### Termination Features

Crimp Width	2.79 mm[.11 in]
-------------	-----------------

### Mechanical Attachment

Wire Insulation Support	Without
-------------------------	---------

### Dimensions

Wire Size	1500 – 5000 CMA
-----------	-----------------

Terminal Material Thickness	.51 mm[.02 in]
-----------------------------	----------------

Product Length	5.72 mm[.225 in]
----------------	------------------

### Usage Conditions

Insulation Option	Uninsulated
-------------------	-------------

Operating Temperature Range	-65 – 150 °C[-85 – 302 °F]
-----------------------------	----------------------------

### Operation/Application

Compatible With Wire Base Material	Aluminum, Copper
------------------------------------	------------------

### Industry Standards

Government Qualified Splice	No
-----------------------------	----

### Packaging Features

Packaging Quantity	30000
--------------------	-------

Packaging Method	Strip
------------------	-------

### Product Compliance

[For compliance documentation, visit the product page on TE.com>](#)

EU RoHS Directive 2011/65/EU	Compliant
------------------------------	-----------

EU ELV Directive 2000/53/EC	Compliant
-----------------------------	-----------

China RoHS 2 Directive MIIT Order No 32, 2016	No Restricted Materials Above Threshold
---	---

EU REACH Regulation (EC) No. 1907/2006	Current ECHA Candidate List: JUNE 2023 (235) Candidate List Declared Against: JUNE 2023 (235) Does not contain REACH SVHC
--	---

Halogen Content	Low Halogen - Br, Cl, F, I < 900 ppm per homogenous material. Also BFR/CFR/PVC Free
-----------------	---

## Solder Process Capability

Not applicable for solder process capability

## Product Compliance Disclaimer

This information is provided based on reasonable inquiry of our suppliers and represents our current actual knowledge based on the information they provided. This information is subject to change. The part numbers that TE has identified as EU RoHS compliant have a maximum concentration of 0.1% by weight in homogenous materials for lead, hexavalent chromium, mercury, PBB, PBDE, DBP, BBP, DEHP, DIBP, and 0.01% for cadmium, or qualify for an exemption to these limits as defined in the Annexes of Directive 2011/65/EU (RoHS2). Finished electrical and electronic equipment products will be CE marked as required by Directive 2011/65/EU. Components may not be CE marked. Additionally, the part numbers that TE has identified as EU ELV compliant have a maximum concentration of 0.1% by weight in homogenous materials for lead, hexavalent chromium, and mercury, and 0.01% for cadmium, or qualify for an exemption to these limits as defined in the Annexes of Directive 2000/53/EC (ELV). Regarding the REACH Regulation, the information TE provides on SVHC in articles for this part number is based on the latest European Chemicals Agency (ECHA) 'Guidance on requirements for substances in articles' posted at this URL: <https://echa.europa.eu/guidance-documents/guidance-on-reach>

## Compatible Parts

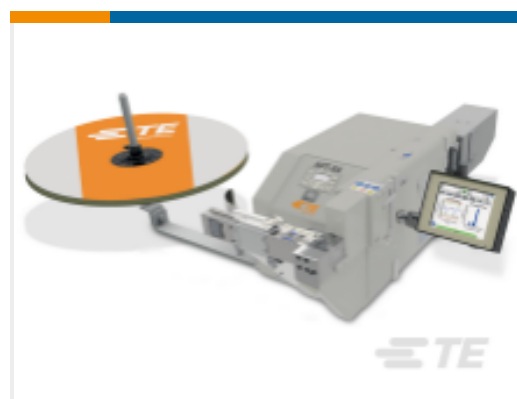

TE Part # 1-2161800-1  
APT-5A TERMINATING MACHINE

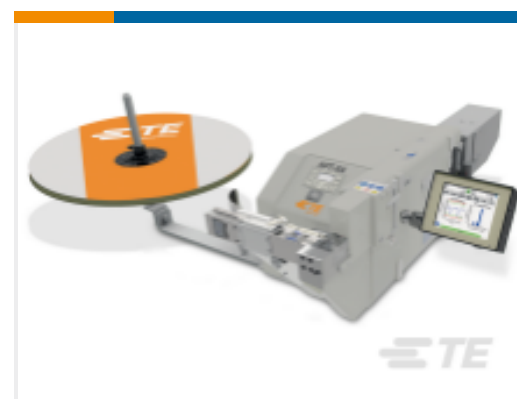

TE Part # 1-2161800-0  
APT-5A TERMINATING MACHINE



TE Part # 1-2161900-0  
APT-5E TERMINATING MACHINE



TE Part # 1-2161900-1  
APT-5E TERMINATING MACHINE



TE Part # 1-2161900-8  
APT-5E TERMINATING MACHINE

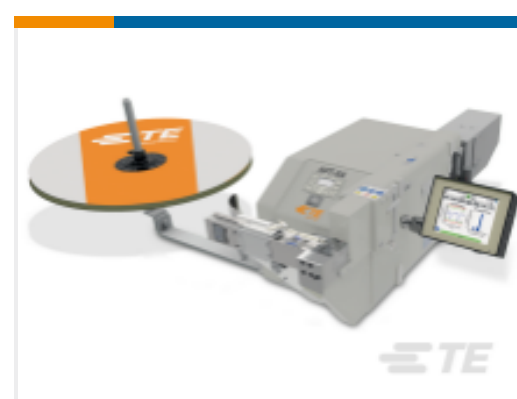

TE Part # 1-2326135-0  
APT-5A INFINITE SPLICE

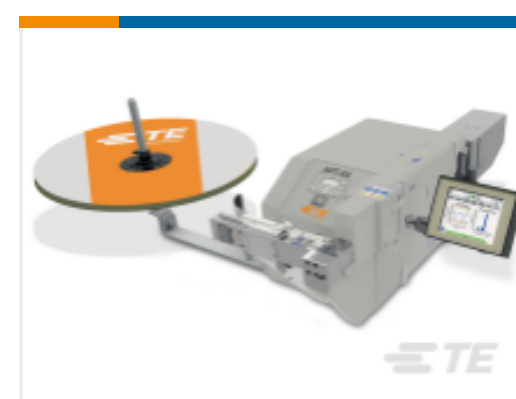

TE Part # 1-2326135-1  
APT-5A INFINITE SPLICE

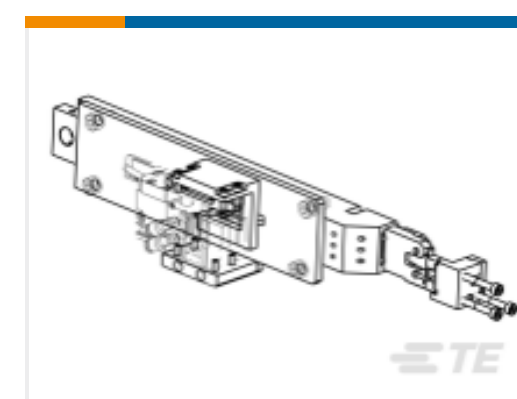

TE Part # 1-2326143-0  
RETROFIT KIT, INFINITE SPLICE



TE Part # 1-2326145-0  
APT-5E INFINITE SPLICE



TE Part # 1742348-1  
9 Serr AMPLIVAR Spade



TE Part # 1855674-2  
END FEED HDM/FA 140F-AMPLIVAR  
SPLICE



TE Part # 2-4150000-2  
OCEAN\_2.0\_Applicator-E-140F



TE Part # 2150117-2  
OCEAN-2.0-APPLICATOR-E-110F



TE Part # 2305750-1  
SYSTEM, INVERTED SPLICE



TE Part # 2305750-2  
SYSTEM, INVERTED SPLICE



TE Part # 2305750-3  
APPLICATOR, INVERTED SPLICE



TE Part # 4150000-2  
OCEAN\_2.0\_Appliator-E-140F



TE Part # 7-2150117-2  
OCEAN-2.0-APPLICATOR-E-110F



TE Part # 7-2150117-7  
OCEAN\_2.0\_SPARE\_PART\_KIT-110F

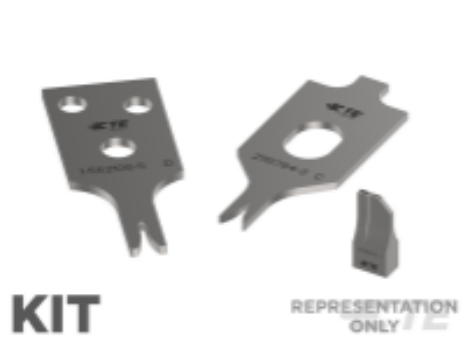

TE Part # 7-2305750-7  
CRIMP TOOLING KIT

Also in the Series | **AMPLIVAR**



Crimp Wire Pins, Tabs & Ferrules(5)



Magnet Wire Terminals(4)



PCB Terminals(1)



Quick Disconnects(41)



Ring Terminals(28)



Splices(77)

Customers Also Bought



TE Part #170147-2  
MNL SOCKET PRE-TIN PH BR



TE Part #1-454276-1  
FLOATING SHEAR



TE Part #62306-1  
SPLICE, AMPLIVAR



TE Part #62420-9  
MAG-MATE TERM 20-22 016

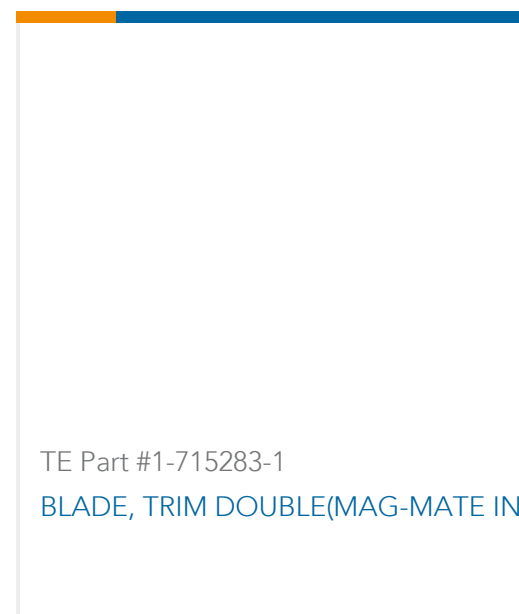

## Documents

### Product Drawings

[AMVAR SPLC 1500-5000 020TPBR](#)

English

### CAD Files

[3D PDF](#)

3D

Customer View Model

[ENG\\_CVM\\_CVM\\_62306-2\\_S.2d\\_dxf.zip](#)

English

Customer View Model

[ENG\\_CVM\\_CVM\\_62306-2\\_S.3d\\_igs.zip](#)

English

Customer View Model

[ENG\\_CVM\\_CVM\\_62306-2\\_S.3d\\_stp.zip](#)

English

By downloading the CAD file I accept and agree to the [Terms and Conditions](#) of use.

### Datasheets & Catalog Pages

[1654742\\_HOUSEHOLD\\_APPLIANCES\\_RAST5](#)

English

### Magnet Wire Terminals & Splices

English

[AMPLIVAR Splices for Multiple Bussed Splicing Product Flyer](#)

English

### Product Specifications



### Application Specification

English

---

### Product Environmental Compliance

[MD\\_62306-2\\_03132018158\\_dmtec](#)

English

[MD\\_62306-2\\_03132018158\\_dmtec](#)

English