

62305-2 ✓ ACTIVE



AMPLIVAR

TE Internal #: 62305-2

Splices, Pigtail Splice, 22 – 15 AWG Wire Size, .3 – 1.5 mm² Wire Size, Splice Capacity 3, Serrated, 600 – 3000 CMA Wire Size, Brass, AMPLIVAR

[View on TE.com >](#)

Terminals & Splices > Splices

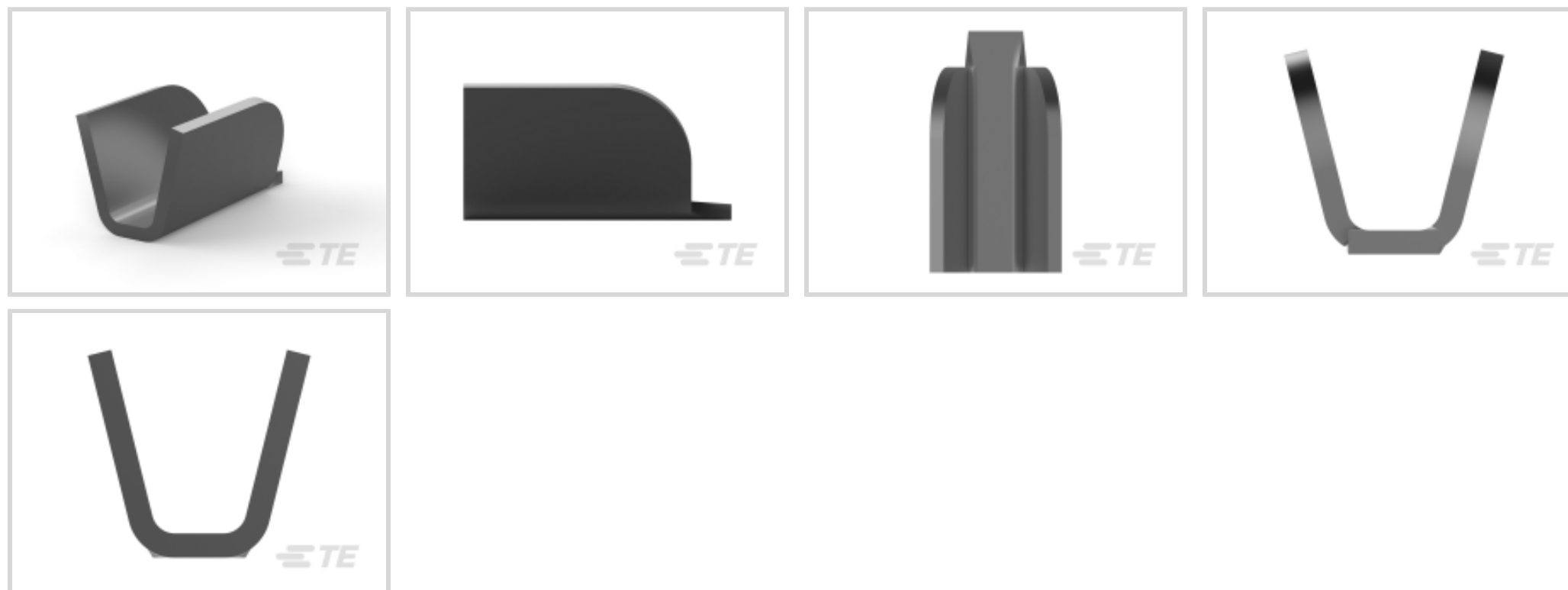

Wire Size: .3 – 1.5 mm²

Sealable: No

Splice Capacity: 3

Splice Features: Serrated

Features

Product Type Features

Sealable	No
Splice Type	Pigtail Splice
Compatible With Discrete Wire Type	Magnet Wire, Solid

Configuration Features

Strip Orientation	End Feed
Splice Capacity	3
Number of Serrations	9

Electrical Characteristics

Operating Voltage	250 V
-------------------	-------

Body Features

Product Weight	.181 g
Splice Features	Serrated

Contact Features

Terminal Plating Material	Tin
---------------------------	-----



Contact Base Material	Brass
-----------------------	-------

Barrel Type	Open
-------------	------

Termination Features

Crimp Width	2.79 mm[.11 in]
-------------	-----------------

Mechanical Attachment

Wire Insulation Support	Without
-------------------------	---------

Dimensions

Wire Size	600 – 3000 CMA
-----------	----------------

Terminal Material Thickness	.41 mm[.016 in]
-----------------------------	-----------------

Product Length	5.72 mm[.225 in]
----------------	------------------

Usage Conditions

Insulation Option	Uninsulated
-------------------	-------------

Operating Temperature Range	-65 – 150 °C[-85 – 302 °F]
-----------------------------	----------------------------

Operation/Application

Compatible With Wire Base Material	Copper
------------------------------------	--------

Industry Standards

Government Qualified Splice	No
-----------------------------	----

Packaging Features

Packaging Quantity	30000
--------------------	-------

Packaging Method	Strip
------------------	-------

Other

Terminals & Splices Comment	Splice recommended for applications using wire size 28 AWG or smaller.
-----------------------------	--

Product Compliance

[For compliance documentation, visit the product page on TE.com>](#)

EU RoHS Directive 2011/65/EU	Compliant
------------------------------	-----------

EU ELV Directive 2000/53/EC	Compliant
-----------------------------	-----------

China RoHS 2 Directive MIIT Order No 32, 2016	No Restricted Materials Above Threshold
---	---

EU REACH Regulation (EC) No. 1907/2006	Current ECHA Candidate List: JUNE 2023 (235) Candidate List Declared Against: JUNE 2023 (235)
--	--

Does not contain REACH SVHC

Halogen Content

Low Halogen - Br, Cl, F, I < 900 ppm per homogenous material. Also BFR/CFR/PVC Free

Solder Process Capability

Not applicable for solder process capability

Product Compliance Disclaimer

This information is provided based on reasonable inquiry of our suppliers and represents our current actual knowledge based on the information they provided. This information is subject to change. The part numbers that TE has identified as EU RoHS compliant have a maximum concentration of 0.1% by weight in homogenous materials for lead, hexavalent chromium, mercury, PBB, PBDE, DBP, BBP, DEHP, DIBP, and 0.01% for cadmium, or qualify for an exemption to these limits as defined in the Annexes of Directive 2011/65/EU (RoHS2). Finished electrical and electronic equipment products will be CE marked as required by Directive 2011/65/EU. Components may not be CE marked. Additionally, the part numbers that TE has identified as EU ELV compliant have a maximum concentration of 0.1% by weight in homogenous materials for lead, hexavalent chromium, and mercury, and 0.01% for cadmium, or qualify for an exemption to these limits as defined in the Annexes of Directive 2000/53/EC (ELV). Regarding the REACH Regulation, the information TE provides on SVHC in articles for this part number is based on the latest European Chemicals Agency (ECHA) 'Guidance on requirements for substances in articles' posted at this URL: <https://echa.europa.eu/guidance-documents/guidance-on-reach>

Compatible Parts



TE Part # 62194-2
MIN AMVAR SPLC 016TPBR



TE Part # 737060-2
AMPLIVAR SPL 5 SERR W/INS SUP



TE Part # 1-2161800-2
APT-5A TERMINATING MACHINE



TE Part # 1-2161800-6
APT 5A



TE Part # 1-2161900-2
APT-5E TERMINATING MACHINE



TE Part # 1-2326135-2
APT-5A INFINITE SPLICE

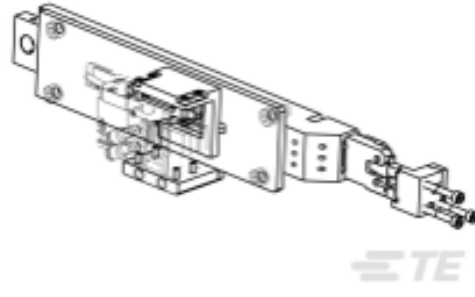

TE Part # 1-2326143-2
RETROFIT KIT, INFINITE SPLICE



TE Part # 1-2326145-2
APT-5E INFINITE SPLICE



TE Part # 1742348-1
9 Serr AMPLIVAR Spade



TE Part # 2150117-2
OCEAN-2.0-APPLICATOR-E-110F



TE Part # 7-2150117-2
OCEAN-2.0-APPLICATOR-E-110F

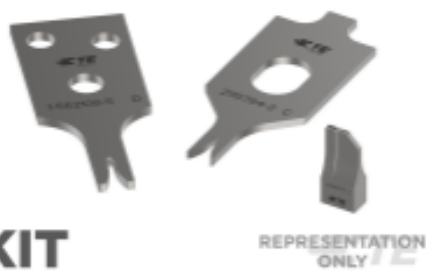

TE Part # 7-2150117-7
OCEAN_2.0_SPARE_PART_KIT-110F

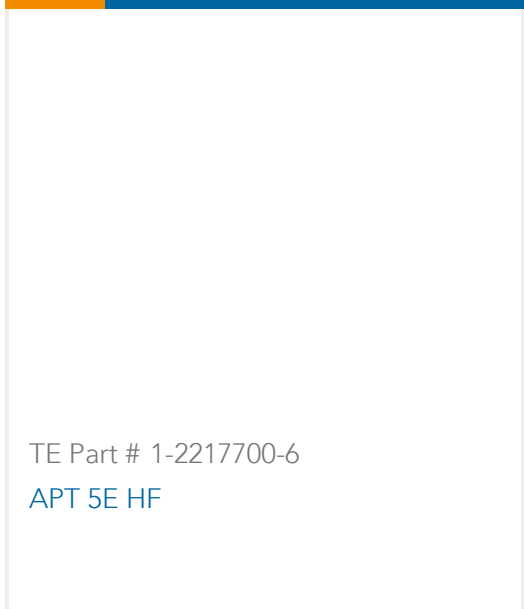
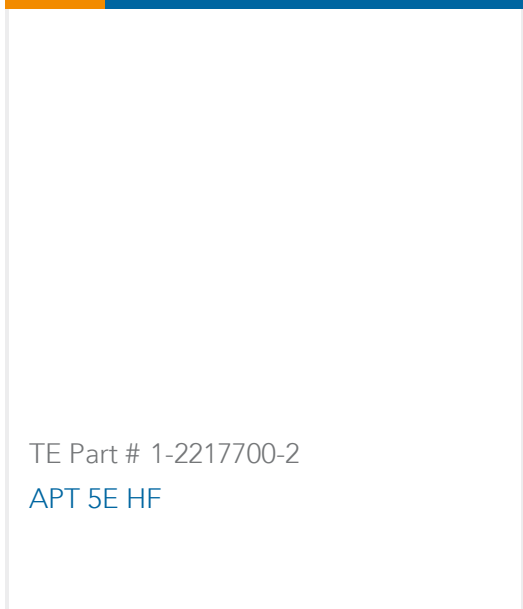
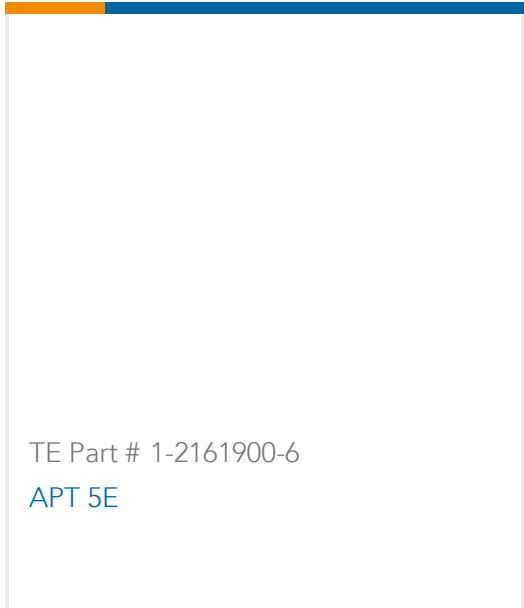

Also in the Series | **AMPLIVAR**

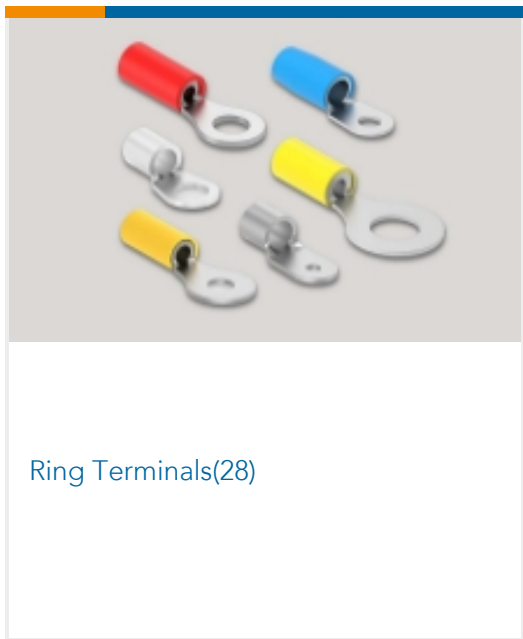
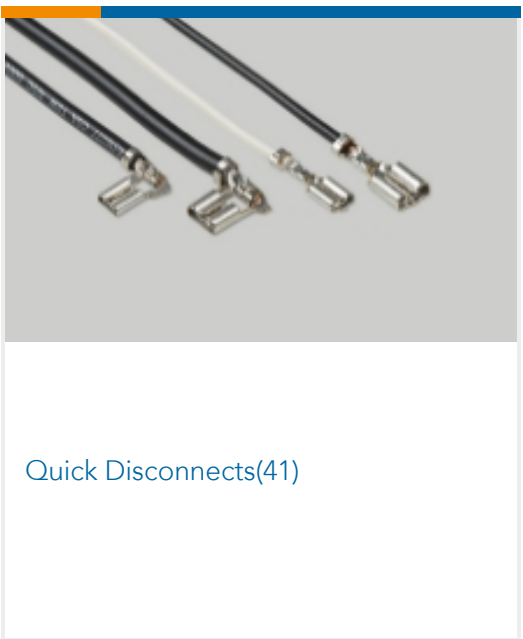

Customers Also Bought



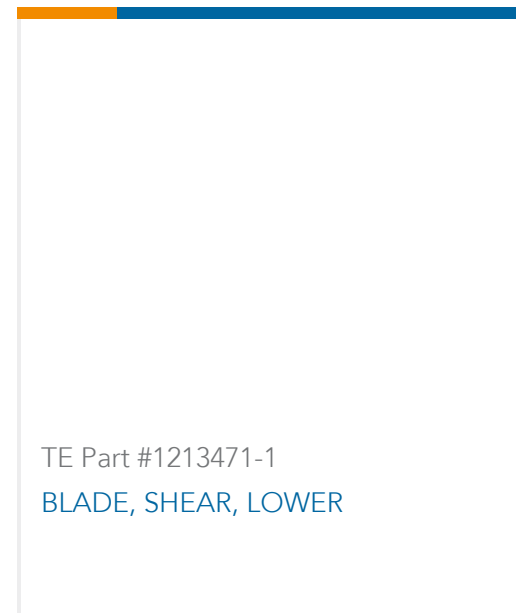

Documents

Product Drawings

[AMVAR SPLC 600-3000 016TPBR](#)

English

CAD Files

[3D PDF](#)

3D

Customer View Model

[ENG_CVM_CVM_62305-2_N.2d_dxf.zip](#)

English

Customer View Model

[ENG_CVM_CVM_62305-2_N.3d_igs.zip](#)

English

Customer View Model

[ENG_CVM_CVM_62305-2_N.3d_stp.zip](#)

English

By downloading the CAD file I accept and agree to the [Terms and Conditions](#) of use.

Datasheets & Catalog Pages

[1654742_HOUSEHOLD_APPLIANCES_RAST5](#)

English

[Magnet Wire Terminals & Splices](#)

English

Product Specifications

[Application Specification](#)

English

Product Environmental Compliance

[MD_62305-2_101320172312_dmtec](#)

English

[MD_62305-2_101320172312_dmtec](#)

English