

61117-4 ✓ ACTIVE

MATE-N-LOK | Commercial MATE-N-LOK

TE Internal #: 61117-4

Power Contacts, Contact, 250 VAC, Tin, 20 – 14 AWG Wire Size, .52

– 2.08 mm<sup>2</sup> Wire Size, Wire & Cable, Crimp, Power, Socket,

Commercial MATE-N-LOK

[View on TE.com >](#)



Connectors > Power Connectors > Power Contacts



Power Contact Type: **Contact**

Operating Voltage: **250 VAC**

Contact Mating Area Plating Material: **Tin**

Wire Size: **.52 – 2.08 mm<sup>2</sup>**

## Features

### Product Type Features

Compatible With Discrete Wire Type	Stranded
Power Contact Type	Contact
Connector & Contact Terminates To	Wire & Cable

### Electrical Characteristics

Operating Voltage	250 VAC
-------------------	---------

### Contact Features

Contact Shape & Form	Round
Barrel Type	Open
Contact Mating Area Plating Material	Tin
Contact Current Rating (Max)	15 A
Contact Type	Socket
Contact Retention Within Housing	With
Mating Pin Diameter	2.13 mm[.084 in]
Contact Base Material	Phosphor Bronze
Wire Contact Termination Area Plating Thickness	.508 – .812 μm[20 – 32 μin]



Wire Contact Termination Area Plating Material	Tin
--	-----

Contact Orientation	Straight
---------------------	----------

### Termination Features

Termination Method to Wire & Cable	Crimp
------------------------------------	-------

### Mechanical Attachment

Contact Retention Type Within Housing	Locking Lance
---------------------------------------	---------------

Wire Insulation Support	Without
-------------------------	---------

### Dimensions

Wire Size	.52 – 2.08 mm <sup>2</sup>
-----------	----------------------------

Compatible Insulation Diameter Range	3.3 mm[.13 in]
--------------------------------------	----------------

### Usage Conditions

Operating Temperature Range	-55 – 105 °C[-67 – 221 °F]
-----------------------------	----------------------------

### Operation/Application

Circuit Application	Power
---------------------	-------

### Packaging Features

Packaging Quantity	5000
--------------------	------

Packaging Method	Reel
------------------	------

### Product Compliance

[For compliance documentation, visit the product page on TE.com>](#)

EU RoHS Directive 2011/65/EU	Compliant
------------------------------	-----------

EU ELV Directive 2000/53/EC	Compliant
-----------------------------	-----------

China RoHS 2 Directive MIIT Order No 32, 2016	No Restricted Materials Above Threshold
---	---

EU REACH Regulation (EC) No. 1907/2006	Current ECHA Candidate List: JUNE 2023 (235) Candidate List Declared Against: JUNE 2023 (235) Does not contain REACH SVHC
--	---

Halogen Content	Low Halogen - Br, Cl, F, I < 900 ppm per homogenous material. Also BFR/CFR/PVC Free
-----------------	---

Solder Process Capability	Not applicable for solder process capability
---------------------------	--

Product Compliance Disclaimer

This information is provided based on reasonable inquiry of our suppliers and represents our current actual knowledge based on the information they provided. This information is subject to change. The part numbers that TE has identified as EU RoHS compliant have a maximum concentration of 0.1% by weight in homogenous materials for lead, hexavalent chromium, mercury, PBB, PBDE, DBP, BBP, DEHP, DIBP, and 0.01% for cadmium, or qualify for an exemption to these limits as defined in the Annexes of Directive 2011/65/EU (RoHS2). Finished electrical and electronic equipment products will be CE marked as required by Directive 2011/65/EU. Components may not be CE marked. Additionally, the part numbers that TE has identified as EU ELV compliant have a maximum concentration of 0.1% by weight in homogenous materials for lead, hexavalent chromium, and mercury, and 0.01% for cadmium, or qualify for an exemption to these limits as defined in the Annexes of Directive 2000/53/EC (ELV). Regarding the REACH Regulation, the information TE provides on SVHC in articles for this part number is based on the latest European Chemicals Agency (ECHA) 'Guidance on requirements for substances in articles' posted at this URL: <https://echa.europa.eu/guidance-documents/guidance-on-reach>

## Compatible Parts



TE Part # 91504-1  
CCII CMNL MNL PIN SKT 20-14 ASSY



TE Part # 455830-1  
INSERTION TOOL

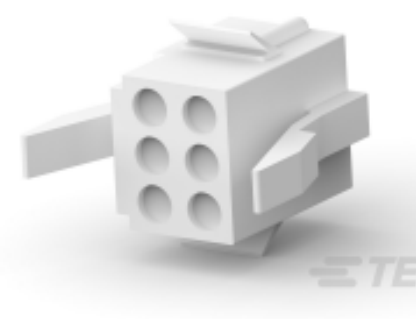

TE Part # 1-171196-0  
6 POS MATE-N-LOK S

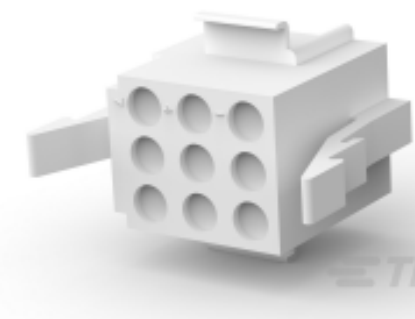

TE Part # 1-480274-0  
09P CMNL PLUG HSG P/M NATL

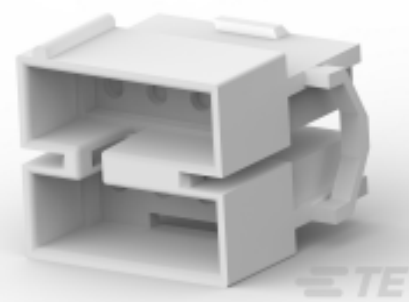

TE Part # 1-480284-0  
08P CMNL CAP HSG M/M NATL



TE Part # 1-480438-0  
16P CMNL PLUG HSG M/M NATL

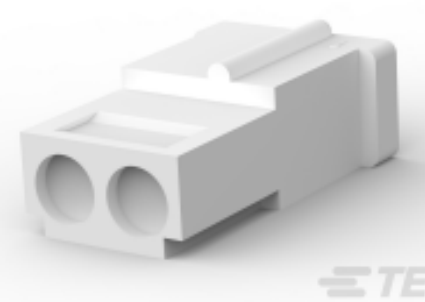

TE Part # 1-480683-0  
02P CMNL PLUG HSG F/H NATL

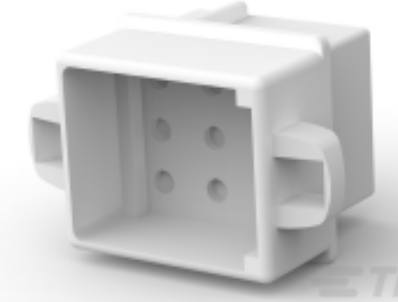

TE Part # 1-480277-0  
09P CMNL CAP HSG P/M NATL

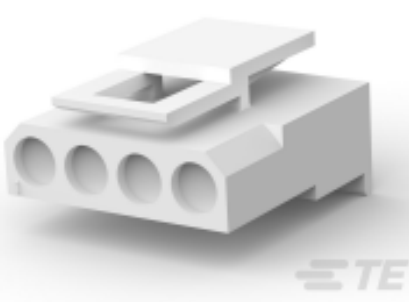

TE Part # 1-480722-0  
04P CMNL PLUG HSG W/LCK NATL



TE Part # 1-480276-0  
06P CMNL CAP HSG P/M NATL



TE Part # 1-480285-0  
10P CMNL PLUG HSG M/M NATL

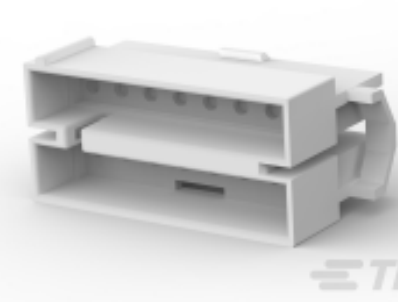

TE Part # 1-480439-0  
16P CMNL CAP HSG M/M NATL



TE Part # 1-480393-1  
02P CMNL PLUG HSG F/H BLK

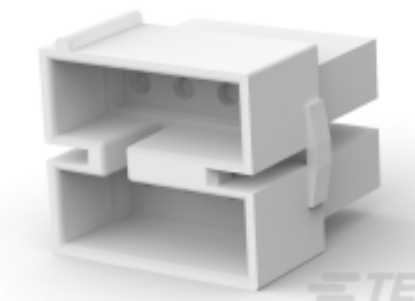

TE Part # 1-480345-0  
08P CMNL CAP HSG F/H NATL

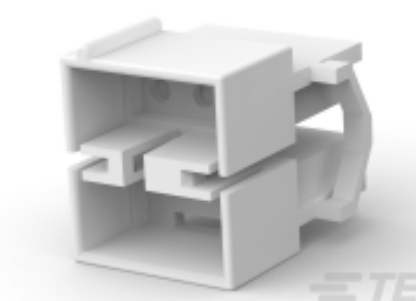

TE Part # 1-480340-0  
06P CMNL CAP HSG F/H NATL

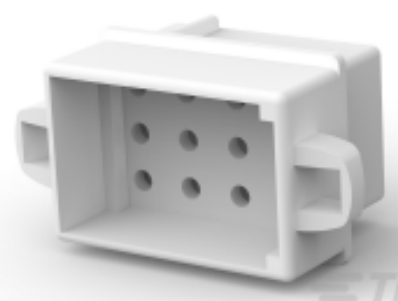

TE Part # 1-480278-0  
12P CMNL CAP HSG P/M NATL



Also in the Series | Commercial MATE-N-LOK

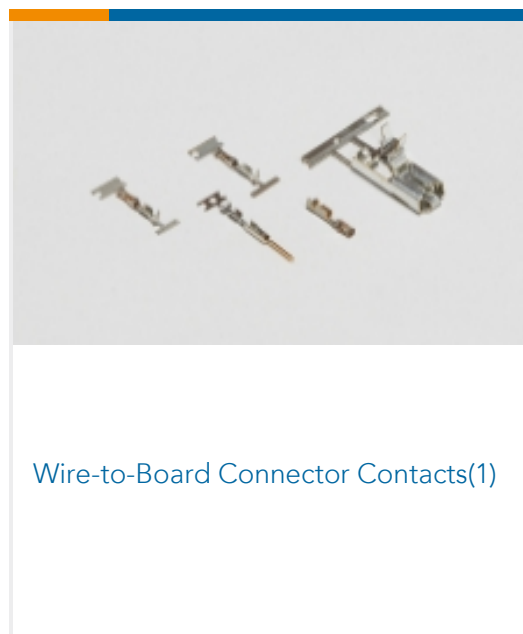
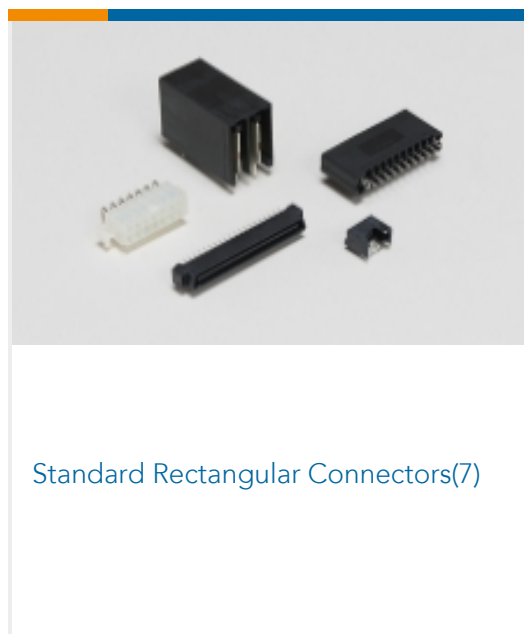
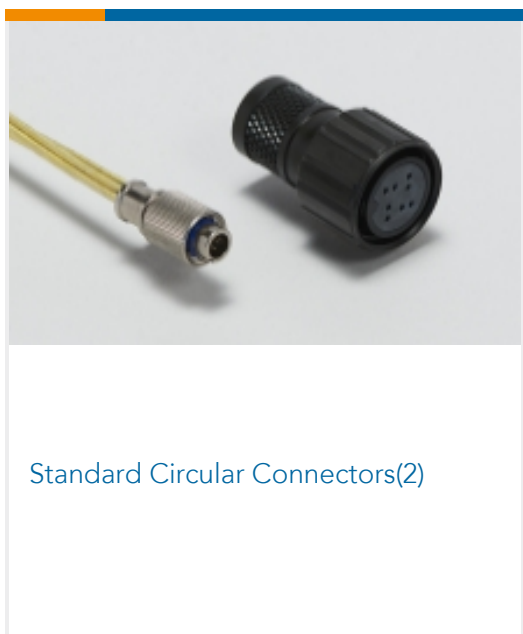
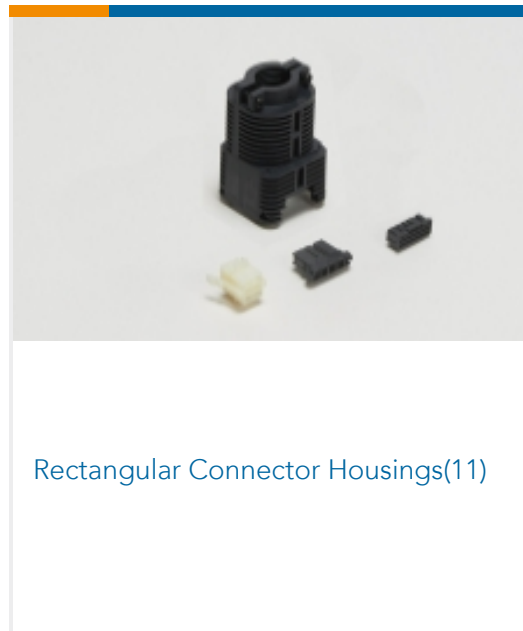
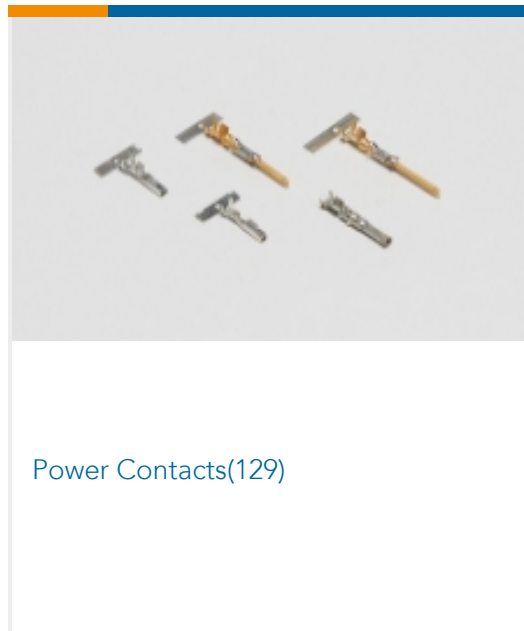
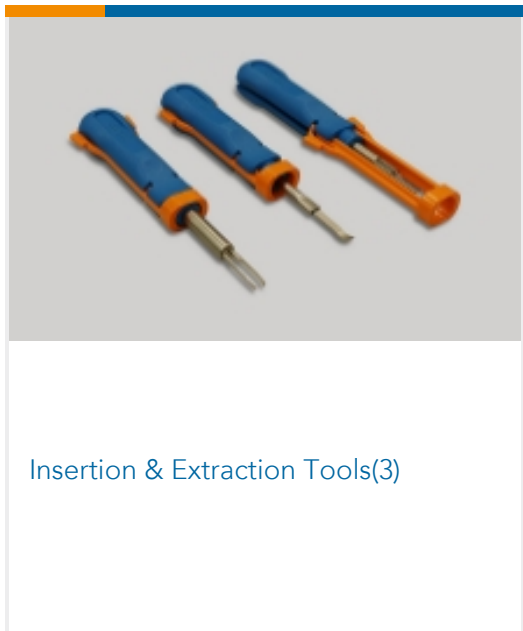
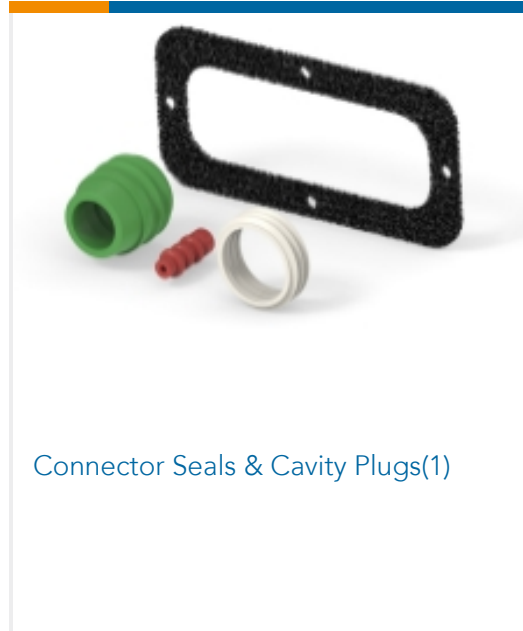
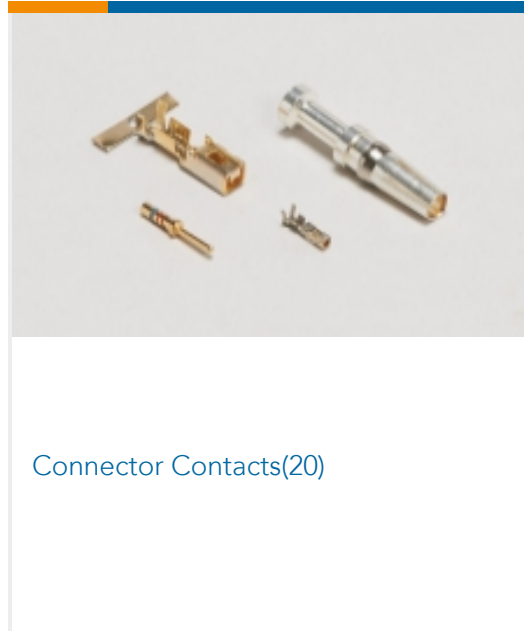
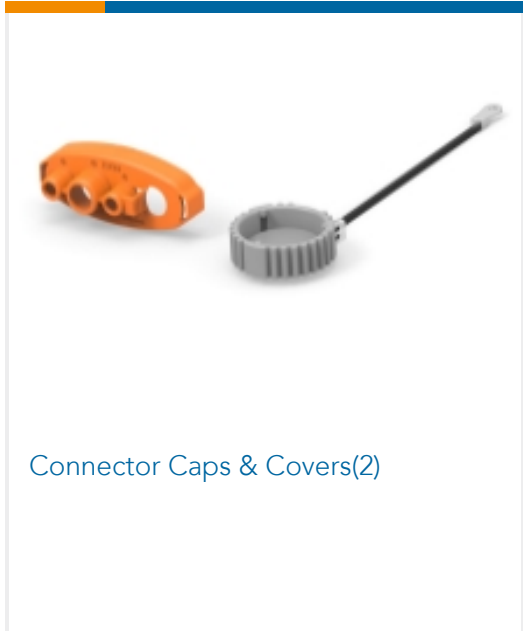

Customers Also Bought



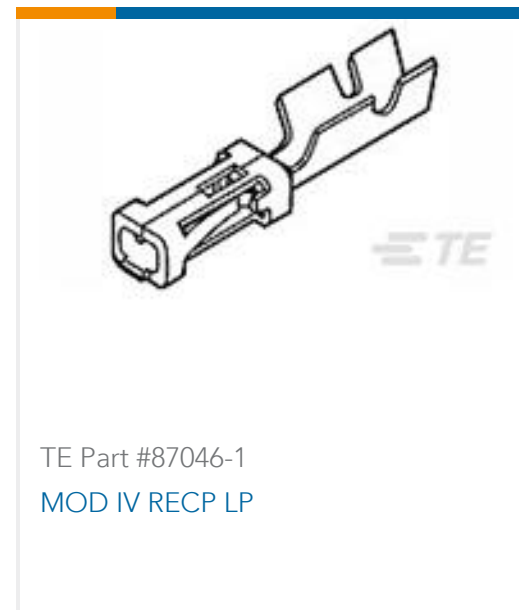

## Documents

### Product Drawings

CMNL SOK 20-14 TPPHBZ

English

### CAD Files

3D PDF

English

Customer View Model

[ENG\\_CVM\\_61117-4\\_AC.2d\\_dxf.zip](#)

English

Customer View Model

[ENG\\_CVM\\_61117-4\\_AC.3d\\_igs.zip](#)

English

Customer View Model

[ENG\\_CVM\\_61117-4\\_AC.3d\\_stp.zip](#)

English

3D PDF

3D

Customer View Model

[ENG\\_CVM\\_CVM\\_61117-4\\_BJ.2d\\_dxf.zip](#)

English

Customer View Model

[ENG\\_CVM\\_CVM\\_61117-4\\_BJ.3d\\_igs.zip](#)

English

Customer View Model

[ENG\\_CVM\\_CVM\\_61117-4\\_BJ.3d\\_stp.zip](#)

English



By downloading the CAD file I accept and agree to the [Terms and Conditions](#) of use.

---

### Datasheets & Catalog Pages

[SOFT\\_SHELL\\_PIN\\_SOCKET\\_CONNECTORS\\_STANDARD\\_DENSITY](#)

English

---

### Product Specifications

[Application Specification](#)

English

---

### Product Environmental Compliance

[MD\\_61117-4\\_112520182253\\_dmtec](#)

English

[MD\\_61117-4\\_112520182253\\_dmtec](#)

English