

60775-2 ✓ ACTIVE

TE Internal #: 60775-2

Spade Tongue Terminal, 18 – 14 AWG, #10 Stud Size, 4.82 mm [.19 in] Stud Diameter, Open Barrel, Straight, Tin, Uninsulated

[View on TE.com >](#)



Terminals & Splices > Spade Terminals

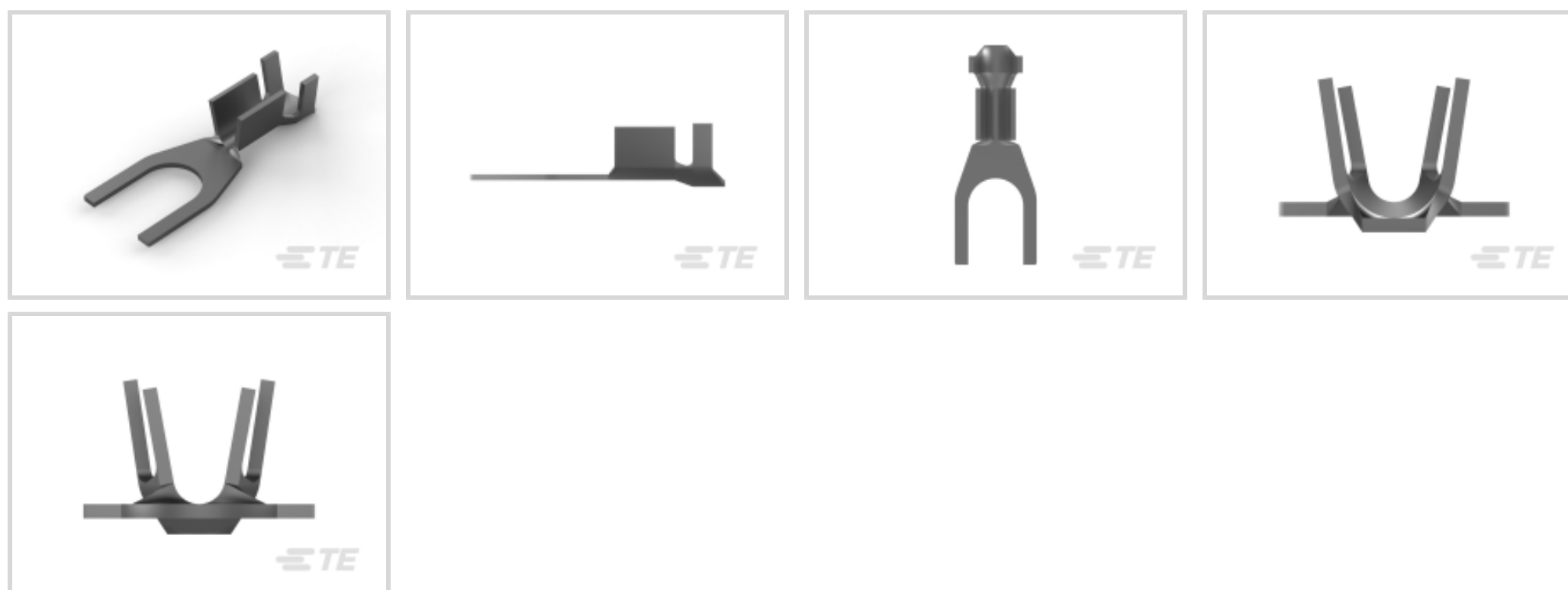

Spade Terminal Type: **Spade Tongue Terminal**

Wire Size: **1624 – 4106 CMA**

Stud Size: **#10**

Features

Product Type Features

Shape Description	Square Spade
Stud Size	#10
Sealable	No
Compatible With Discrete Wire Type	Stranded
Wire Insulation Support Retention Type	Insulation Support

Contact Features

Contact Base Material	Brass
Spade Terminal Type	Spade Tongue Terminal
Barrel Type	Open
Terminal Orientation	Straight
Terminal Plating Material	Tin
Contact Underplating Material	None

Mechanical Attachment

Wire Insulation Support	With
-------------------------	------

Dimensions

	.1 in
--	-------



Wire Size	1624 – 4106 CMA
Stud Diameter	4.82 mm [.19 in]
Tongue Thickness	.46 mm [.018 in]
Product Length	20.32 mm [.8 in]
Barrel Inside Diameter	1.65 mm, 3.04 mm [.065 in] [.12 in]
Compatible Insulation Diameter (Max)	3.56 mm [.14 in]
Compatible Insulation Diameter Range	2.54 – 3.56 mm [.1 – .14 in]

Usage Conditions

Insulation Option	Uninsulated
Operating Temperature Range	-40 – 110 °C [-40 – 230 °F]

Operation/Application

Compatible With Wire Base Material	Copper
------------------------------------	--------

Industry Standards

Government Qualified Terminal	No
-------------------------------	----

Packaging Features

Packaging Quantity	12000
Packaging Method	Strip/Reel

Product Compliance

[For compliance documentation, visit the product page on TE.com>](#)











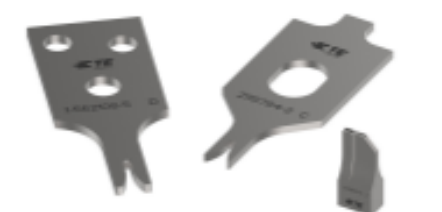

EU RoHS Directive 2011/65/EU	Compliant
EU ELV Directive 2000/53/EC	Compliant
China RoHS 2 Directive MIIT Order No 32, 2016	No Restricted Materials Above Threshold
EU REACH Regulation (EC) No. 1907/2006	Current ECHA Candidate List: JUNE 2023 (235) Candidate List Declared Against: JUNE 2023 (235) Does not contain REACH SVHC
Halogen Content	Low Halogen - Br, Cl, F, I < 900 ppm per homogenous material. Also BFR/CFR/PVC Free
Solder Process Capability	Not applicable for solder process capability

Product Compliance Disclaimer

This information is provided based on reasonable inquiry of our suppliers and represents our current actual knowledge based on the information they provided. This information is subject to change. The part numbers that TE has identified as

EU RoHS compliant have a maximum concentration of 0.1% by weight in homogenous materials for lead, hexavalent chromium, mercury, PBB, PBDE, DBP, BBP, DEHP, DIBP, and 0.01% for cadmium, or qualify for an exemption to these limits as defined in the Annexes of Directive 2011/65/EU (RoHS2). Finished electrical and electronic equipment products will be CE marked as required by Directive 2011/65/EU. Components may not be CE marked. Additionally, the part numbers that TE has identified as EU ELV compliant have a maximum concentration of 0.1% by weight in homogenous materials for lead, hexavalent chromium, and mercury, and 0.01% for cadmium, or qualify for an exemption to these limits as defined in the Annexes of Directive 2000/53/EC (ELV). Regarding the REACH Regulation, the information TE provides on SVHC in articles for this part number is based on the latest European Chemicals Agency (ECHA) 'Guidance on requirements for substances in articles' posted at this URL: <https://echa.europa.eu/guidance-documents/guidance-on-reach>

Compatible Parts

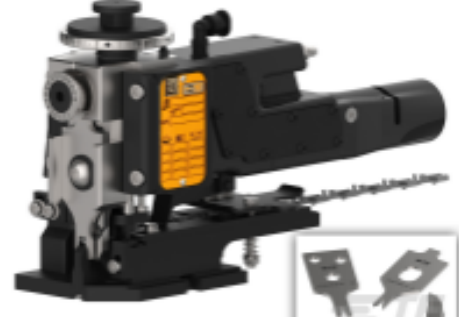
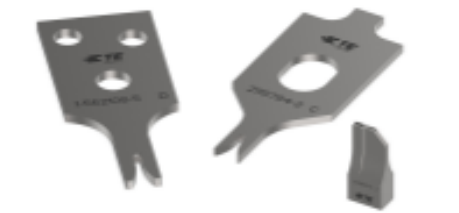
 <p>KIT</p> <p>REPRESENTATION ONLY</p> <p>TE Part # 7-2150380-7 OCEAN_2.0_SPARE_PART_KIT-110F160F</p>	 <p>TE Part # 2-2150380-1 OCEAN_2.0_APPLICATOR-E-110F160F</p>	 <p>TE Part # 2-2150380-2 OCEAN_2.0_APPLICATOR-E-110F160FA</p>	 <p>TE Part # 2-2150575-1 OCEAN_2.0_Applicator-E-110F160F</p>
 <p>TE Part # 2-2150575-2 OCEAN_2.0_Applicator-E-110F160F</p>	 <p>TE Part # 2150380-1 OCEAN_2.0_APPLICATOR-E-110F160F</p>	 <p>TE Part # 2150380-2 OCEAN_2.0_APPLICATOR-E-110F160FA</p>	 <p>TE Part # 2150575-1 OCEAN_2.0_Applicator-E-110F160F</p>
 <p>TE Part # 2150575-2 OCEAN_2.0_Applicator-E-110F160F</p>	 <p>TE Part # 60998-2 TERM SPADE IS 16-14 0305 TPCU</p>	 <p>TE Part # 7-2150380-1 OCEAN_2.0_APPLICATOR-E-110F160F</p>	 <p>TE Part # 7-2150380-2 OCEAN_2.0_APPLICATOR-E-110F160FA</p>
 <p>TE Part # 7-2150575-1 OCEAN_2.0_Applicator-E-110F160F</p>	 <p>TE Part # 7-2150575-2 OCEAN_2.0_Applicator-E-110F160F</p>	 <p>KIT</p> <p>REPRESENTATION ONLY</p> <p>TE Part # 7-2150575-7 OCEAN_2.0_SPARE_PART_KIT-110F160F</p>	

Customers Also Bought



TE Part #1-640251-0
10P SL156 HSG W/O LCK RAMP

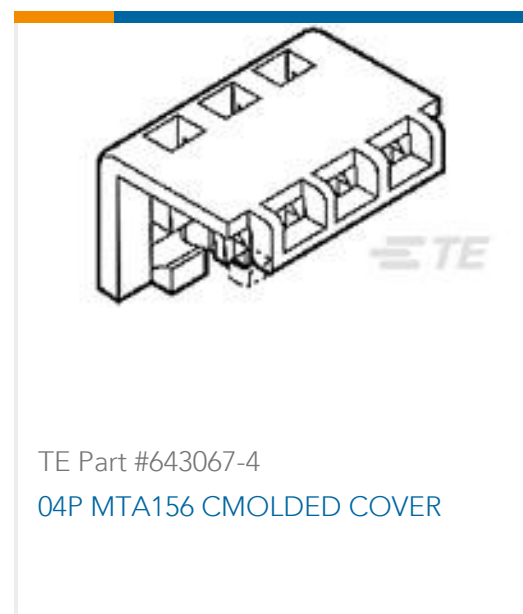

TE Part #643067-4
04P MTA156 CMOLDED COVER



TE Part #172234-1
3P MINI UNIVERSAL MATE-N-LOK
CAP HOUSING

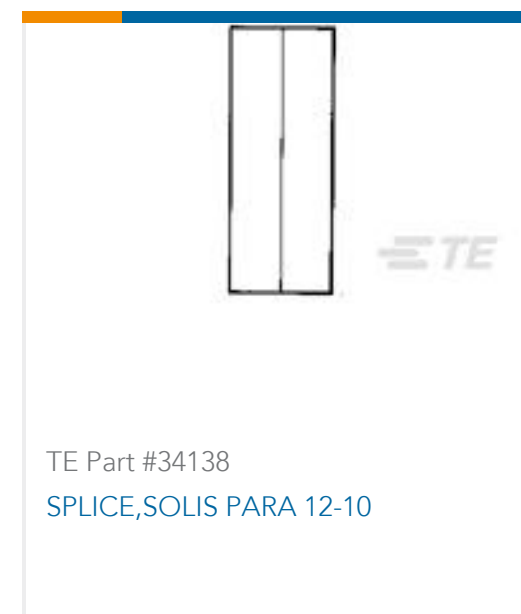

TE Part #34138
SPLICE, SOLIS PARA 12-10



TE Part #63010-1
250 FASTON FLAG REC 18-14 AWG
TPBR

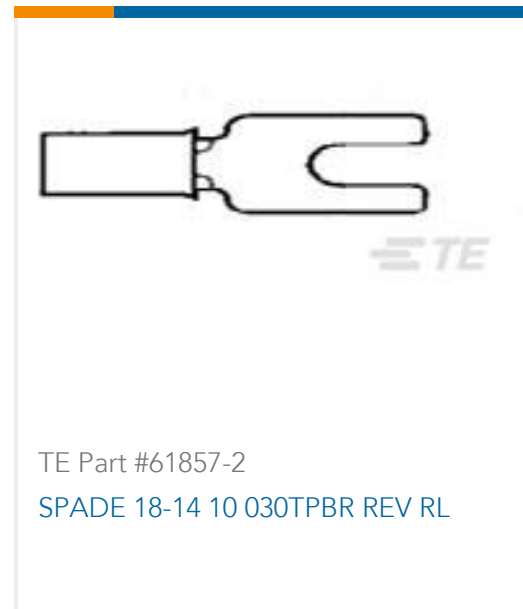

TE Part #61857-2
SPADE 18-14 10 030TPBR REV RL



TE Part #5-547217-5
PROTECTION COVER, COSMIC 32M

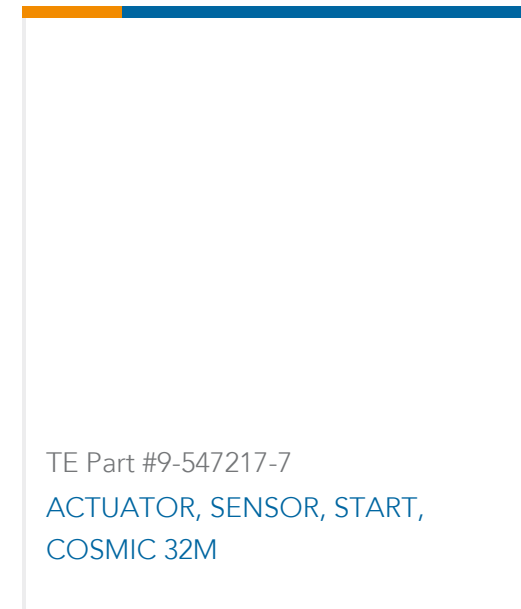

TE Part #9-547217-7
ACTUATOR, SENSOR, START,
COSMIC 32M

Documents

Product Drawings

SPADE TERMINAL 18-14 AWG TPBR

English

CAD Files

3D PDF

3D

Customer View Model

[ENG_CVM_CVM_60775-2_M_c-60775-2-m.2d_dxf.zip](#)

English

Customer View Model

[ENG_CVM_CVM_60775-2_M_c-60775-2-m.3d_igs.zip](#)

English

Customer View Model

[ENG_CVM_CVM_60775-2_M_c-60775-2-m.3d_stp.zip](#)

English

By downloading the CAD file I accept and agree to the [Terms and Conditions](#) of use.

Product Specifications

Application Specification

English

Product Environmental Compliance

MD_60775-2_10142011630

English

MD_60775-2_10142011630

English

60775-2

Spade Tongue Terminal, 18 – 14 AWG, #10 Stud Size, 4.82 mm [.19 in] Stud Diameter,
Open Barrel, Straight, Tin, Uninsulated

