

60650-2 ✓ ACTIVE

FASTON 250

TE Internal #: 60650-2

TE Internal Description: 250 FASTON FLAG REC 18-14 AWG TPBR

[View on TE.com >](#)

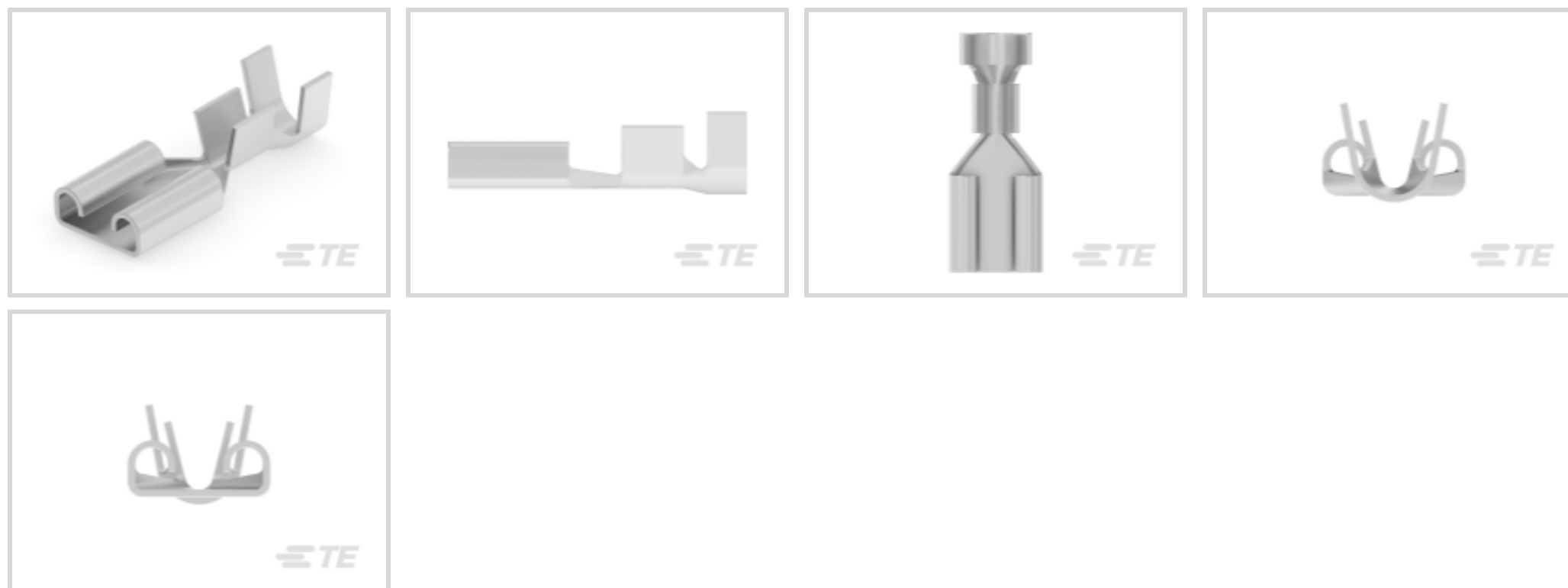

Product Compliance

[For compliance documentation, visit the product page on TE.com>](#)

EU RoHS Directive 2011/65/EU	Compliant
EU ELV Directive 2000/53/EC	Compliant
China RoHS 2 Directive MIIT Order No 32, 2016	No Restricted Materials Above Threshold
EU REACH Regulation (EC) No. 1907/2006	Current ECHA Candidate List: JUNE 2023 (235) Candidate List Declared Against: JUNE 2023 (235) Does not contain REACH SVHC
Halogen Content	Low Halogen - Br, Cl, F, I < 900 ppm per homogenous material. Also BFR/CFR/PVC Free
Solder Process Capability	Not applicable for solder process capability

Product Compliance Disclaimer

This information is provided based on reasonable inquiry of our suppliers and represents our current actual knowledge based on the information they provided. This information is subject to change. The part numbers that TE has identified as EU RoHS compliant have a maximum concentration of 0.1% by weight in homogenous materials for lead, hexavalent chromium, mercury, PBB, PBDE, DBP, BBP, DEHP, DIBP, and 0.01% for cadmium, or qualify for an exemption to these limits as defined in the Annexes of Directive 2011/65/EU (RoHS2). Finished electrical and electronic equipment products will be CE marked as required by Directive 2011/65/EU. Components may not be CE marked. Additionally, the part numbers that TE has identified as EU ELV compliant have a maximum concentration of 0.1% by weight in homogenous materials for lead, hexavalent chromium, and mercury, and 0.01% for cadmium, or qualify for an exemption to these limits as defined in the Annexes of Directive 2000/53/EC (ELV). Regarding the REACH Regulation, the information TE provides on SVHC in articles for this part number is based on the latest European Chemicals Agency (ECHA) 'Guidance on requirements for substances in articles' posted at this URL: <https://echa.europa.eu/guidance-documents/guidance-on-reach>

Compatible Parts

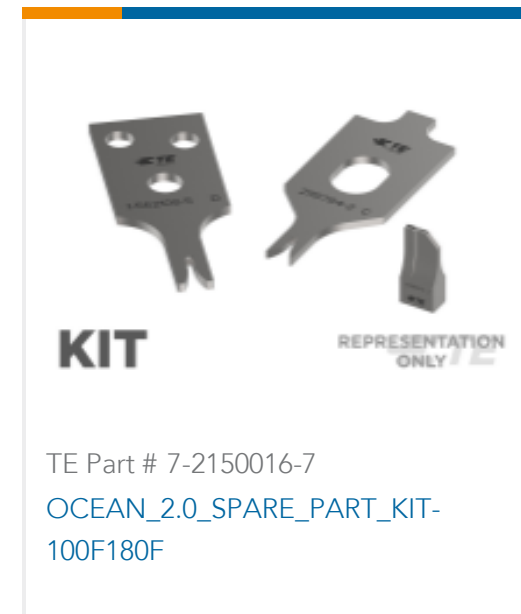
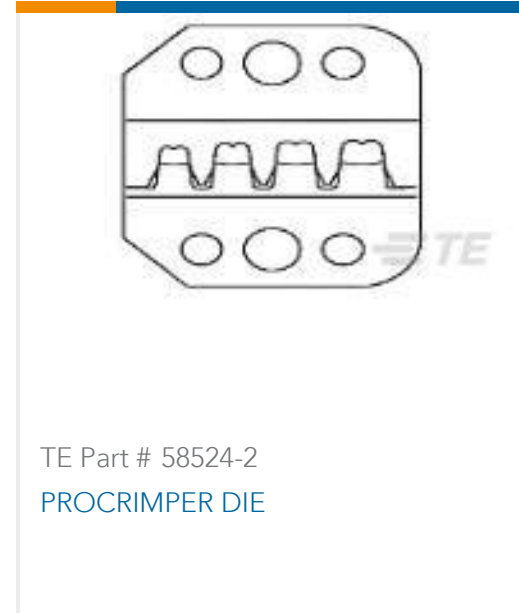

Also in the Series | **FASTON 250**

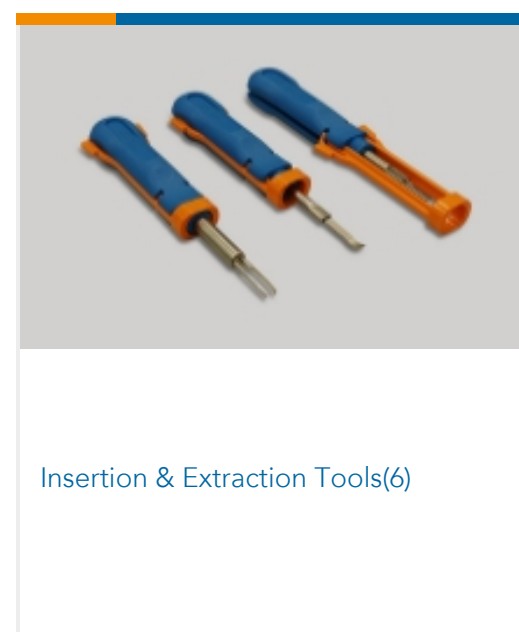
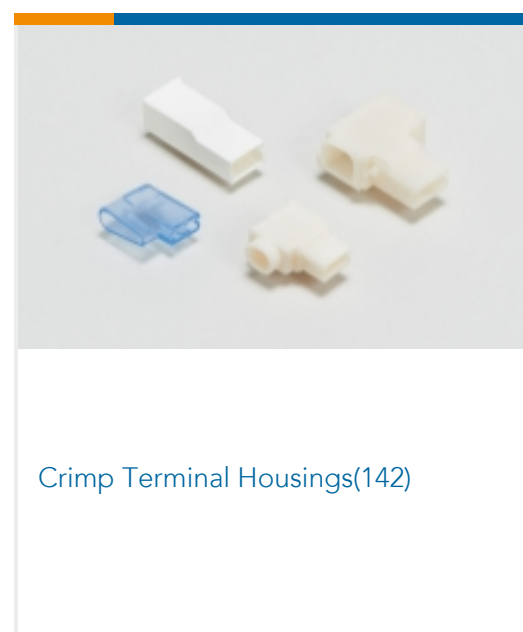
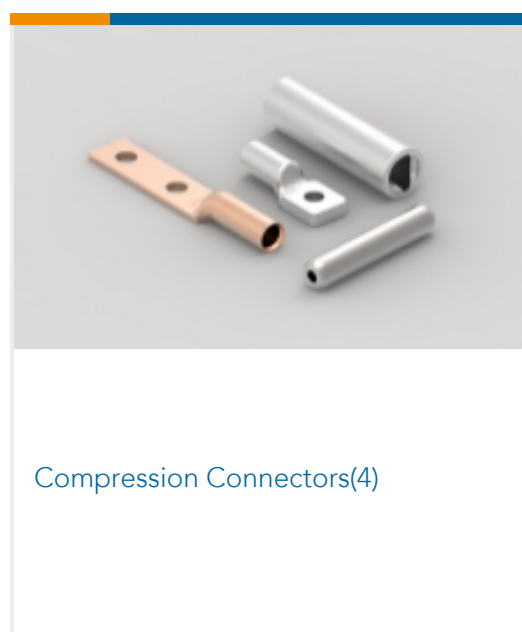



PCB Terminals(135)

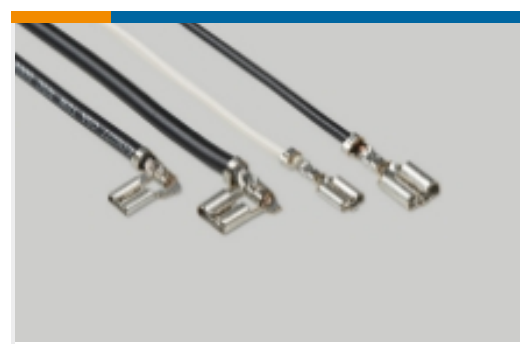

Quick Disconnects(445)



Splices(4)

Customers Also Bought

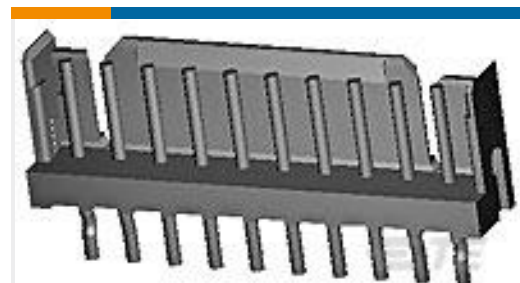
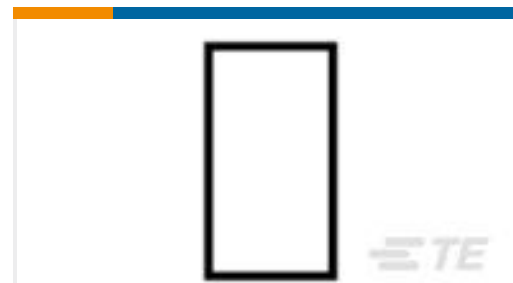
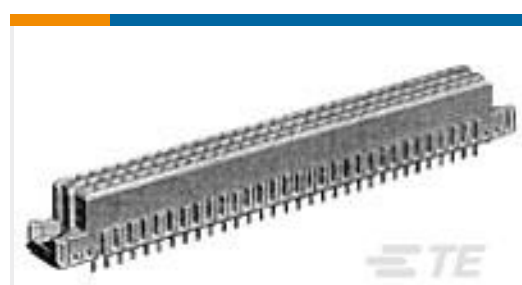
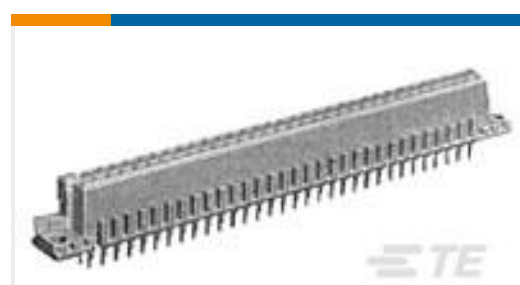
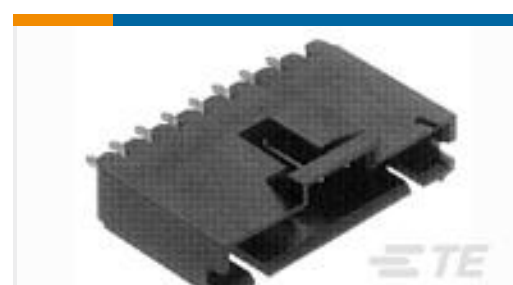
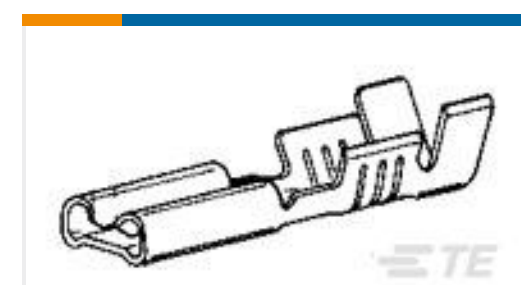
TE Part #3-641239-5
05P MTA100 CONN ASSY BLU LFTE Part #1-292161-0
CT P/HDR ASSY V 10P W/KINK NATTE Part #327637
ADAPTER 12-10/16-14TE Part #6609116-4
10EHG1-2=F8225TE Part #5535089-5
ASSEMBLY,RECEPTACLE,EUROCARD,
TTE Part #5650858-5
ASSEMBLY,RECEPTACLE,EUROCARD,
TTE Part #5-103669-4
05 MTE HDR SRST LATCH W/HLDWNTE Part #140717-2
110 FASTON,REC.,22-18 AWG,PTBRTE Part #201578-1
CONTACT PIN ASSY.TE Part #DT06-4S-CE05
PLG, 4P, BLK, E, SEAL RET, CAP

Documents

Product Drawings

250 FASTON FLAG REC 18-14 AWG TPBR

English

CAD Files

Customer View Model

ENG_CVM_CVM_60650-2_N.2d_dxf.zip

English

3D PDF



3D

Customer View Model

[ENG_CVM_CVM_60650-2_N.3d_igs.zip](#)

English

Customer View Model

[ENG_CVM_CVM_60650-2_N.3d_stp.zip](#)

English

By downloading the CAD file I accept and agree to the [Terms and Conditions](#) of use.

Datasheets & Catalog Pages

[82004 FASTON Terminals \(Insulated and Uninsulated\) Catalog - FASTON Receptacles Section](#)

English

Product Specifications

[Application Specification](#)

English

Product Environmental Compliance

[MD_60650-2_042020142244_dmtec](#)

English

[MD_60650-2_042020142244_dmtec](#)

English