

60279-2 ✓ ACTIVE

FASTON | FASTON 250

TE Internal #: 60279-2

Quick Disconnects, Receptacle, 18 – 14 AWG Wire Size, .82 – 2.08 mm² Wire Size, Mating Tab Width 6.35 mm [.25 in], Piggyback, Brass, FASTON 250

[View on TE.com >](#)



Terminals & Splices > Quick Disconnects

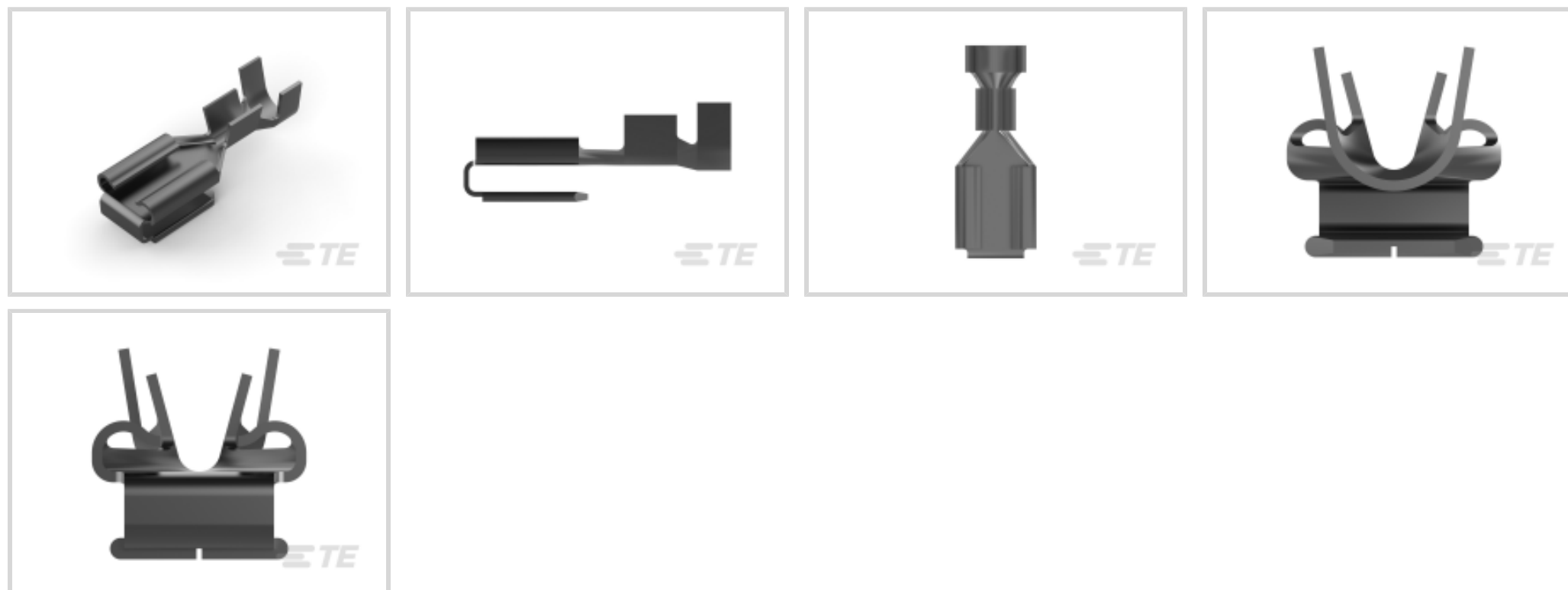

Quick Disconnect Terminal Type: **Receptacle**

Wire Size: .82 – 2.08 mm²

Mating Tab Width: 6.35 mm [.25 in]

Mating Tab Thickness: .81 mm [.032 in]

Features

Product Type Features

Insertion Force	Low
-----------------	-----

Configuration Features

Connection Capacity	Single
---------------------	--------

Compatible With Wire & Cable Type	Discrete Wire
-----------------------------------	---------------

Contact Features

Quick Disconnect Terminal Type	Receptacle
--------------------------------	------------

Mating Tab Width	6.35 mm [.25 in]
------------------	------------------

Mating Tab Thickness	.81 mm [.032 in]
----------------------	------------------

Terminal Orientation	Piggyback
----------------------	-----------

Contact Base Material	Brass
-----------------------	-------

Terminal Plating Material	Tin
---------------------------	-----

Crimp Type	F-Crimp
------------	---------

Barrel Type	Open
-------------	------

Termination Features



Product Terminates To	Wire & Cable
-----------------------	--------------

Mechanical Attachment

Wire Insulation Support	With
Mating Retention Type	Dimple

Dimensions

Terminal Material Thickness	.41 mm[.016 in]
Product Length	20.57 mm[.81 in]
Compatible Insulation Diameter Range	3.1 – 4.3 mm[.12 – .17 in]
Wire Size	.82 – 2.08 mm ²

Usage Conditions

Insulation Option	Uninsulated
Operating Temperature Range	-40 – 110 °C[-40 – 230 °F]

Industry Standards

Agency/Standard	UL
-----------------	----

Packaging Features

Packaging Quantity	1000
Packaging Method	Loose Piece/Carton

Product Compliance

[For compliance documentation, visit the product page on TE.com>](#)

EU RoHS Directive 2011/65/EU	Compliant
EU ELV Directive 2000/53/EC	Compliant
China RoHS 2 Directive MIIT Order No 32, 2016	No Restricted Materials Above Threshold
EU REACH Regulation (EC) No. 1907/2006	Current ECHA Candidate List: JUNE 2023 (235) Candidate List Declared Against: JUNE 2023 (235) Does not contain REACH SVHC
Halogen Content	Low Halogen - Br, Cl, F, I < 900 ppm per homogenous material. Also BFR/CFR/PVC Free
Solder Process Capability	Not applicable for solder process capability

Product Compliance Disclaimer

This information is provided based on reasonable inquiry of our suppliers and represents our current actual knowledge based on the information they provided. This information is subject to change. The part numbers that TE has identified as EU RoHS compliant have a maximum concentration of 0.1% by weight in homogenous materials for lead, hexavalent chromium, mercury, PBB, PBDE, DBP, BBP, DEHP, DIBP, and 0.01% for cadmium, or qualify for an exemption to these limits as defined in the Annexes of Directive 2011/65/EU (RoHS2). Finished electrical and electronic equipment products will be CE marked as required by Directive 2011/65/EU. Components may not be CE marked. Additionally, the part numbers that TE has identified as EU ELV compliant have a maximum concentration of 0.1% by weight in homogenous materials for lead, hexavalent chromium, and mercury, and 0.01% for cadmium, or qualify for an exemption to these limits as defined in the Annexes of Directive 2000/53/EC (ELV). Regarding the REACH Regulation, the information TE provides on SVHC in articles for this part number is based on the latest European Chemicals Agency (ECHA) 'Guidance on requirements for substances in articles' posted at this URL: <https://echa.europa.eu/guidance-documents/guidance-on-reach>

Compatible Parts

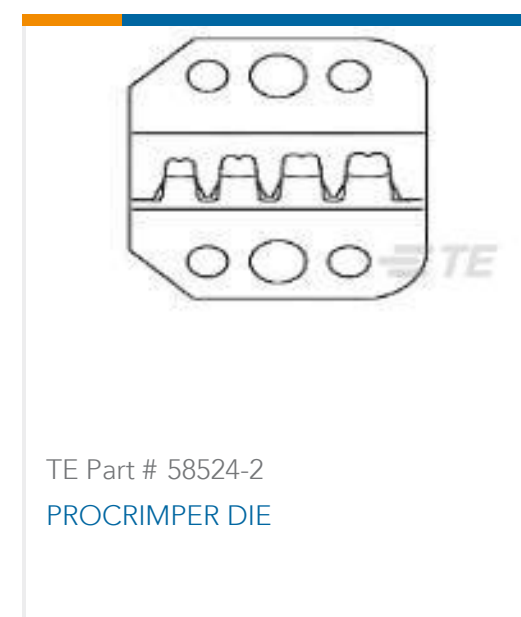

Also in the Series | FASTON 250

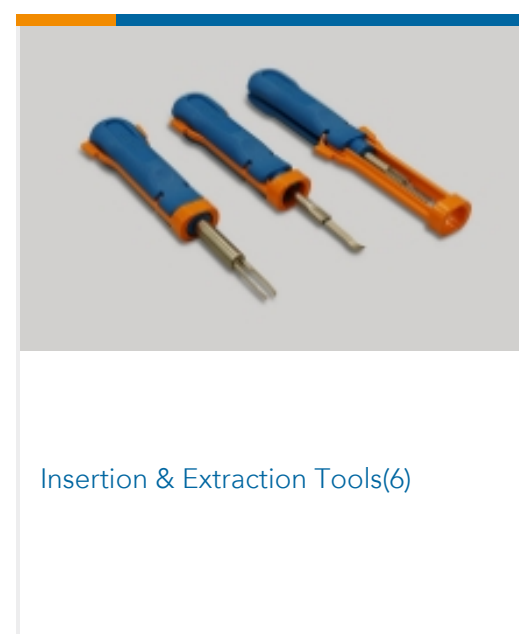
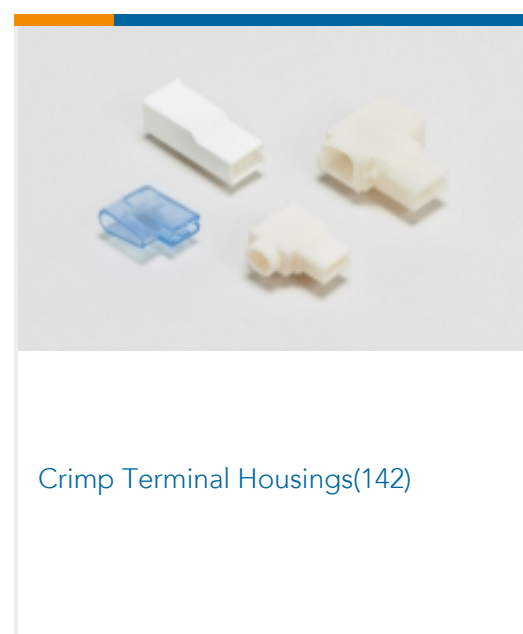
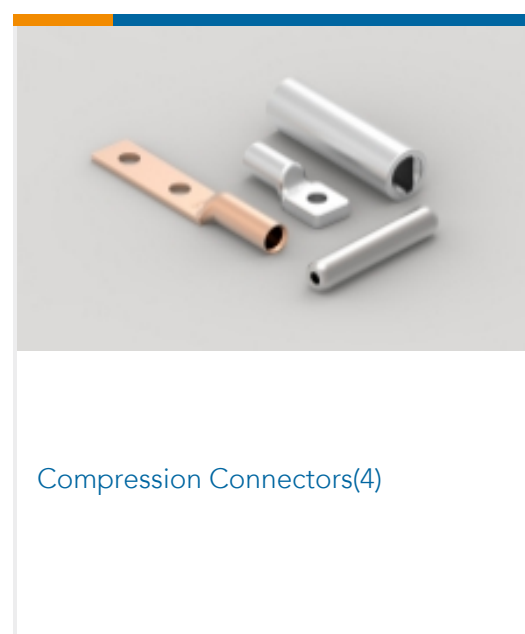



PCB Terminals(135)

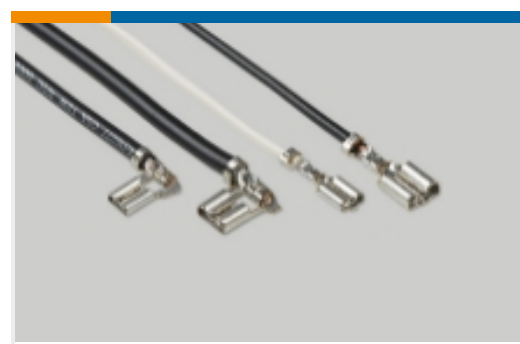

Quick Disconnects(445)



Splices(4)

Customers Also Bought

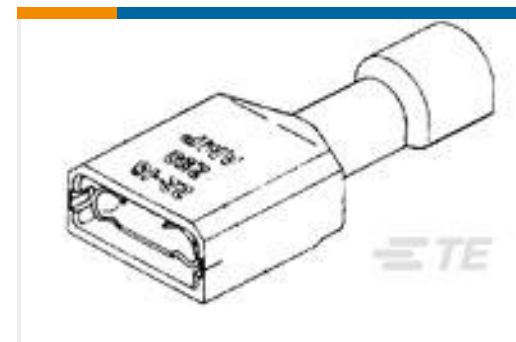
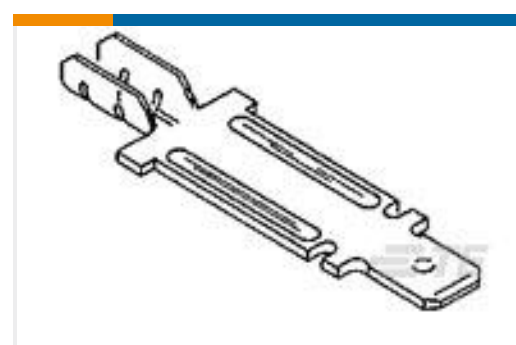
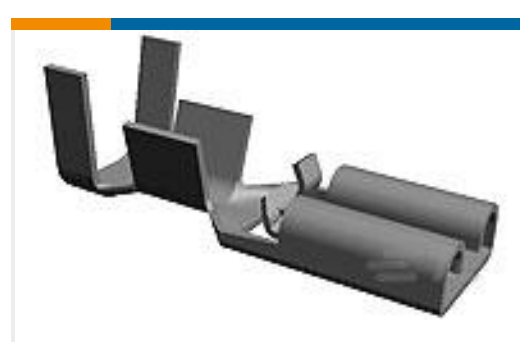
TE Part #2-1879074-3
THS15 50R 5%TE Part #62026-2
187 FASTON REC 20-16 AWG BRTE Part #1-480709-9
12P UMNL CAP HSG BLKTE Part #2-520403-2
ULTRA-FAST 187 ASY REC 22-18 TPBRTE Part #63646-1
187 FASTON REC 20-16 AWG BRTE Part #61375-1
250 FASTON REC 18-14 AWG TPBRTE Part #63301-1
250 FASTON TAB 22-15 AWG NPSTTE Part #6-1393211-0
T92P7A22-24TE Part #NB-PTCO-142
Pt100, 1.2x4.0, Class A, PTFM101A1G0TE Part #1217113-1
PL 187 TERMINAL RECEPTACLE 22-18 AWG BR

Documents

Product Drawings

[250 FASTON REC 18-14 AWG TPBR](#)

English

CAD Files

Customer View Model

[ENG_CVM_CVM_60279-2_N.2d_dxf.zip](#)

English

[3D PDF](#)



3D

Customer View Model

[ENG_CVM_CVM_60279-2_N.3d_igs.zip](#)

English

Customer View Model

[ENG_CVM_CVM_60279-2_N.3d_stp.zip](#)

English

By downloading the CAD file I accept and agree to the [Terms and Conditions](#) of use.

Datasheets & Catalog Pages

[FASTIN_FASTON_Product_Line](#)

English

Product Specifications

[Application Specification](#)

English

Product Environmental Compliance

[MD_60279-2_0711201616_dmtec](#)

English

[MD_60279-2_0711201616_dmtec](#)

English