

6-928918-1 ✓ ACTIVE

MQS

TE Internal #: 6-928918-1

Automotive Terminals, Tab, Mating Tab Width .63 mm [.025 in], Tab

Thickness .63 mm [.025 in], 24 – 22 AWG Wire Size, .2 – .35 mm²

Wire Size, MQS

[View on TE.com >](#)



Terminals & Splices > Automotive Terminals > MQS, RECEPTACLE AND TAB

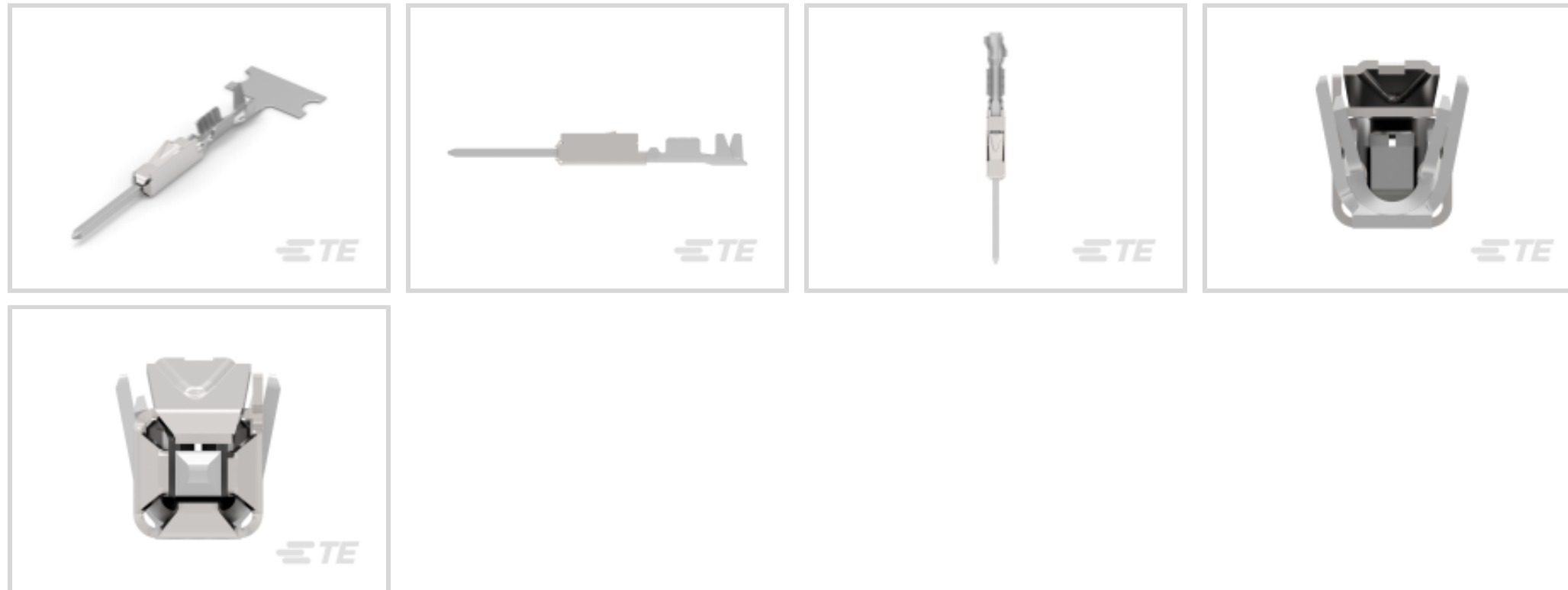

Terminal Type: **Tab**

Mating Tab Width: **.63 mm [.025 in]**

Mating Tab Thickness: **.63 mm [.025 in]**

Terminal Transmits: **0 – 24 A (Low Power)**

Wire Size: **24 – 22 AWG**

[All MQS, RECEPTACLE AND TAB \(126\)](#)

Features

Product Type Features

Receptacle Style	180°
Sealable	No
Primary Locking Feature	Locking Lance

Contact Features

Contact Size	.63mm
Contact Fabrication	Stamped & Formed
Wire Contact Termination Area Plating Material	Tin
Typical Current Rating	7.5 A
Crimp Type	F-Crimp
Terminal Type	Tab
Mating Tab Width	.63 mm[.025 in]
Mating Tab Thickness	.63 mm[.025 in]
Interface Plating	Tin (Sn)



Termination Features

Termination Method to Wire & Cable	Crimp
Product Terminates To	Wire

Dimensions

Compatible Insulation Diameter Range	1.1 – 1.6 mm [.043 – .063 in]
Wire Size	.2 – .35 mm ²
Wire Size Search	22 AWG, 23 AWG, 24 AWG

Usage Conditions

Insulation Option	Uninsulated
Operating Temperature (Max)	80 °C, 85 °C, 90 °C, 100 °C, 105 °C, 110 °C, 120 °C [176 °F][185 °F][194 °F][212 °F][221 °F][230 °F][248 °F]
Operating Temperature Range	-40 – 120 °C [-40 – 248 °F]

Operation/Application

Compatible With Wire Base Material	Copper
------------------------------------	--------

Industry Standards

Agency/Standard	LV214
-----------------	-------

Packaging Features

Packaging Quantity	13000
Packaging Method	Reel

Other

Terminal Transmits	0 – 24 A (Low Power)
--------------------	----------------------

Product Compliance

For compliance documentation, visit the product page on [TE.com](https://www.te.com)>

EU RoHS Directive 2011/65/EU	Compliant
EU ELV Directive 2000/53/EC	Compliant
China RoHS 2 Directive MIIT Order No 32, 2016	No Restricted Materials Above Threshold
EU REACH Regulation (EC) No. 1907/2006	Current ECHA Candidate List: JUNE 2023 (235) Candidate List Declared Against: JUNE 2023 (235) Does not contain REACH SVHC
Halogen Content	Low Halogen - Br, Cl, F, I < 900 ppm per

homogenous material. Also BFR/CFR/PVC Free

Solder Process Capability

Not reviewed for solder process capability

Product Compliance Disclaimer

This information is provided based on reasonable inquiry of our suppliers and represents our current actual knowledge based on the information they provided. This information is subject to change. The part numbers that TE has identified as EU RoHS compliant have a maximum concentration of 0.1% by weight in homogenous materials for lead, hexavalent chromium, mercury, PBB, PBDE, DBP, BBP, DEHP, DIBP, and 0.01% for cadmium, or qualify for an exemption to these limits as defined in the Annexes of Directive 2011/65/EU (RoHS2). Finished electrical and electronic equipment products will be CE marked as required by Directive 2011/65/EU. Components may not be CE marked. Additionally, the part numbers that TE has identified as EU ELV compliant have a maximum concentration of 0.1% by weight in homogenous materials for lead, hexavalent chromium, and mercury, and 0.01% for cadmium, or qualify for an exemption to these limits as defined in the Annexes of Directive 2000/53/EC (ELV). Regarding the REACH Regulation, the information TE provides on SVHC in articles for this part number is based on the latest European Chemicals Agency (ECHA) 'Guidance on requirements for substances in articles' posted at this URL: <https://echa.europa.eu/guidance-documents/guidance-on-reach>

Compatible Parts



TE Part # CAT-M8793-CH8172
MQS, CONNECTOR HOUSING



TE Part # 1452426-1
EXTRACTION TOOL



TE Part # 6-1579007-1
EXTRACTION TOOL



TE Part # 2305570-1
Strip Terminal Cutter-Side Feed-No Crimp



TE Part # 1-963725-1
MQS PIN CONTACT



TE Part # 1-2298627-1
24POS, HYBRID, TAB HSG ASSY, UNSLD, COD A



TE Part # 1308374-1
EXTRACTION TOOL



TE Part # 1579028-8
EXTRACTION TOOL



TE Part # 2-2266165-1
OCEAN_2.0_APPLICATOR-S-055F0720



TE Part # 2063041-1
SDE MQS 0.25-0.5mm² ASSY
REPRESENTATION ONLY, DIE SET MAY VARY.



TE Part # 2063041-2
SDE MQS 0.25-0.5mm² DIE SET



TE Part # 2151493-1
OCEAN_2.0_APPLICATOR-S-055F0720



Also in the Series | MQS

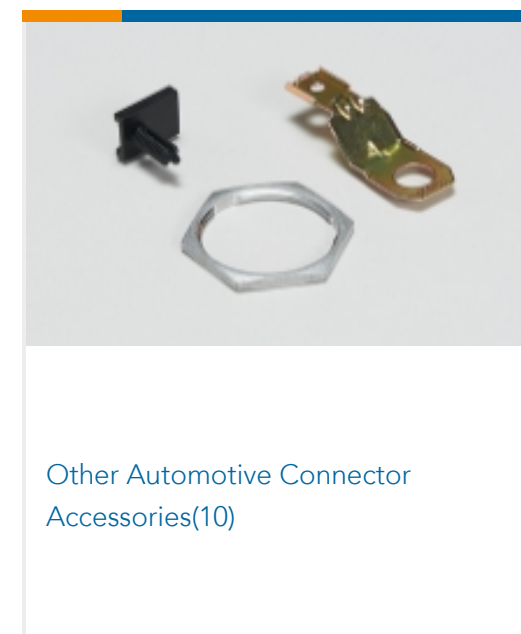
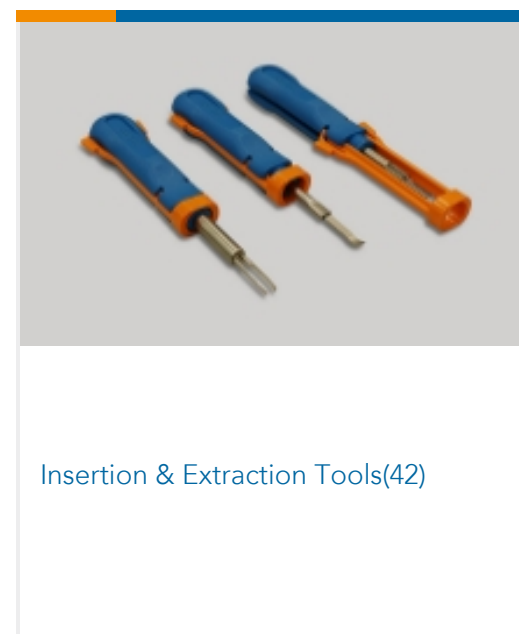
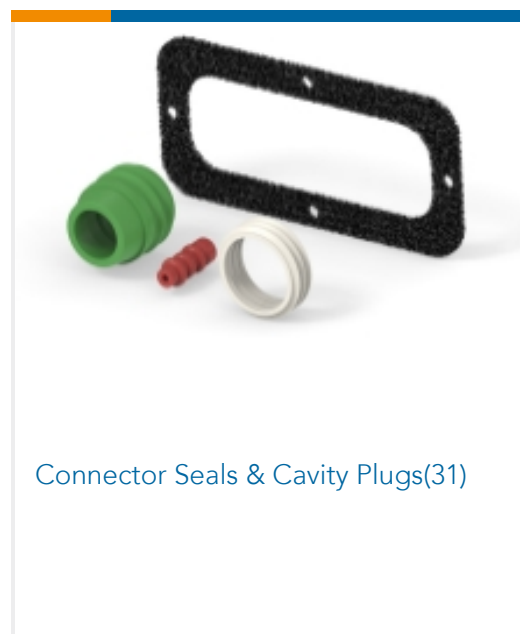
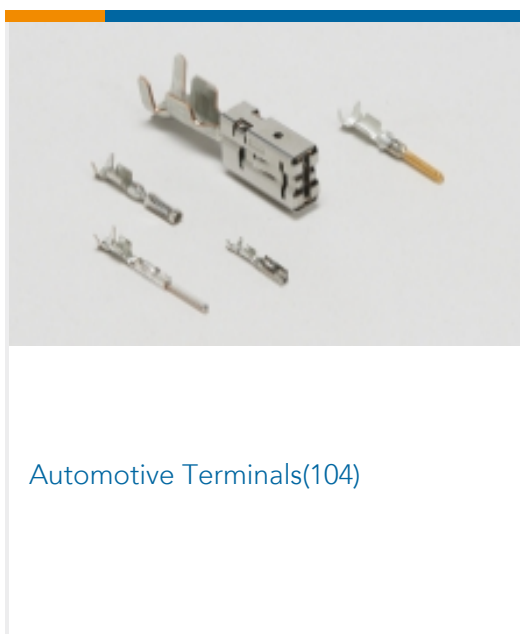
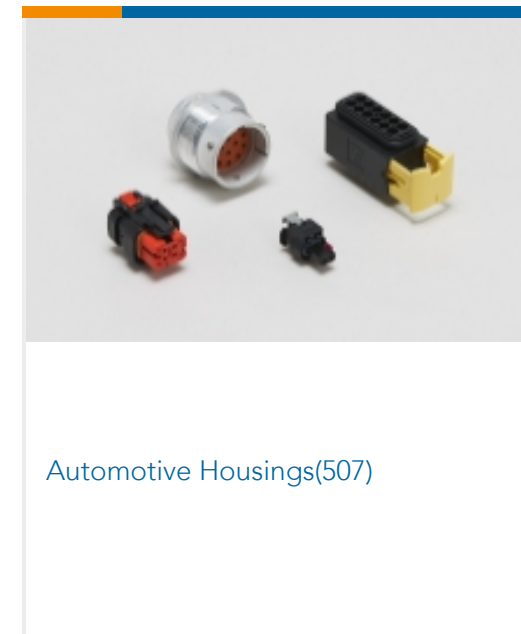

Customers Also Bought



TE Part #2-292227-0
1.5 MINI CT SGL H SMT W BOSS 2



TE Part #1318985-2
DYNAMIC D-5 REC CONT SS FORM A



TE Part #1-1355470-5
2POS MQS TAB COD A

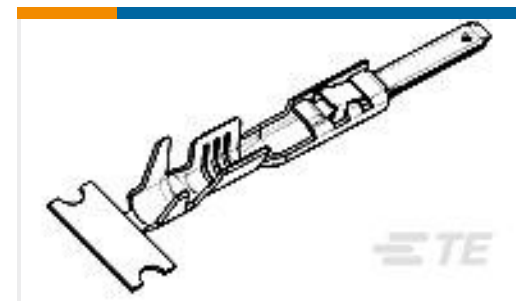

TE Part #1-1452350-1
MQS1,5 Sn tab LL unseal. 0,35-0,5



TE Part #2298566-1
22POSN.,TAB ASSY, MCON1.2, MQS, MCP2.8



TE Part #4-2098269-9
10P Plug Assembly (2x5), Gener



TE Part #6-928918-3
MQS0,63 Ag tab LL unseal. 0,2-0,35



TE Part #936103-2
2.8MM SLD 2P PLUG RETAINER BLK

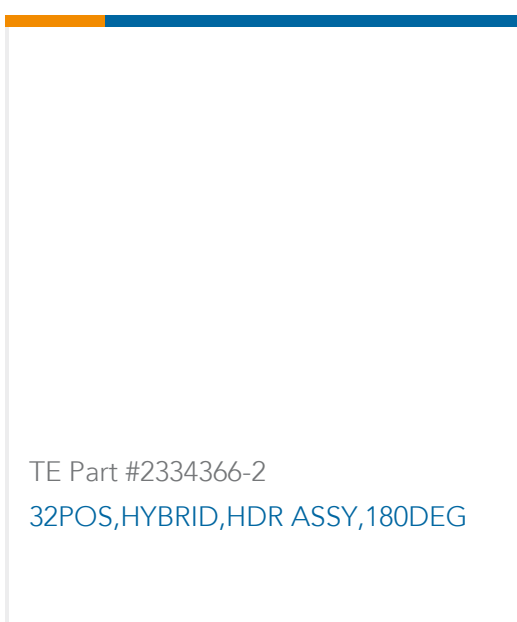

TE Part #2334366-2
32POS, HYBRID, HDR ASSY, 180DEG

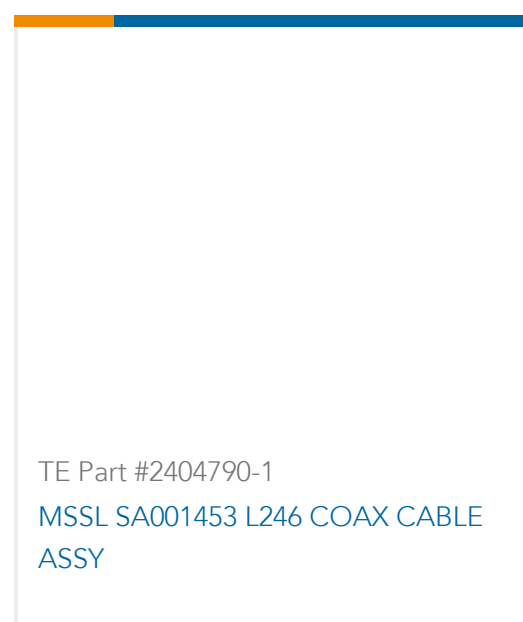

TE Part #2404790-1
MSSL SA001453 L246 COAX CABLE ASSY

Documents

Product Drawings

[MQS0,63 Sn tab LL unseal. 0,2-0,35](#)

English

CAD Files

[3D PDF](#)

3D

Customer View Model

[ENG_CVM_CVM_6-928918-1_W_c-6-928918-1-w.2d_dxf.zip](#)

English

Customer View Model

[ENG_CVM_CVM_6-928918-1_W_c-6-928918-1-w.3d_igs.zip](#)

English

Customer View Model

[ENG_CVM_CVM_6-928918-1_W_c-6-928918-1-w.3d_stp.zip](#)

English

By downloading the CAD file I accept and agree to the [Terms and Conditions](#) of use.

Datasheets & Catalog Pages



Micro Quadlok Interconnection System (MQS)

English

Product Specifications

Application Specification

English

Application Specification

German

Application Specification

English