

6-173977-2 ✓ ACTIVE



AMP CT

TE Internal #: 6-173977-2

Connector Assembly, Receptacle, Wire-to-Board, 2 Position, .079 in [2 mm] Centerline, Insulation Displacement (IDC), 1 Row, Black, AMP CT

[View on TE.com >](#)

[Connectors >](#) [PCB Connectors >](#) [Wire-to-Board Connectors >](#) [Wire-to-Board Connector Assemblies & Housings >](#)

AMP COMMON TERMINATION HOUSINGS



Connector Product Type: **Connector Assembly**

Connector & Housing Type: **Receptacle**

Connector System: **Wire-to-Board**

Number of Positions: **2**

Centerline (Pitch): **2 mm [.079 in]**

[All AMP COMMON TERMINATION HOUSINGS \(176\)](#)

Features

Product Type Features

Connector Product Type	Connector Assembly
Connector & Housing Type	Receptacle
Connector System	Wire-to-Board
Sealable	No
Connector & Contact Terminates To	Wire & Cable

Configuration Features

Number of Positions	2
Number of Rows	1

Body Features

Primary Product Color	Black
-----------------------	-------

Contact Features

--	--



Contact Current Rating (Max)	2 A
------------------------------	-----

Termination Features

Termination Method to Wire & Cable	Insulation Displacement (IDC)
------------------------------------	-------------------------------

Mechanical Attachment

Mating Retention	Without
Connector Mounting Type	Cable Mount (Free-Hanging)

Housing Features

Housing Material	PBT GF
Centerline (Pitch)	2 mm [.079 in]

Usage Conditions

Operating Temperature Range	-30 – 105 °C [-22 – 221 °F]
-----------------------------	-----------------------------

Operation/Application

Circuit Application	Power & Signal
---------------------	----------------

Product Compliance

[For compliance documentation, visit the product page on TE.com>](#)

EU RoHS Directive 2011/65/EU	Compliant
EU ELV Directive 2000/53/EC	Compliant
China RoHS 2 Directive MIIT Order No 32, 2016	No Restricted Materials Above Threshold
EU REACH Regulation (EC) No. 1907/2006	Current ECHA Candidate List: JUNE 2023 (235) Candidate List Declared Against: JUNE 2023 (235) Does not contain REACH SVHC
Halogen Content	Not Low Halogen - contains Br or Cl > 900 ppm.
Solder Process Capability	Not applicable for solder process capability

Product Compliance Disclaimer

This information is provided based on reasonable inquiry of our suppliers and represents our current actual knowledge based on the information they provided. This information is subject to change. The part numbers that TE has identified as EU RoHS compliant have a maximum concentration of 0.1% by weight in homogenous materials for lead, hexavalent chromium, mercury, PBB, PBDE, DBP, BBP, DEHP, DIBP, and 0.01% for cadmium, or qualify for an exemption to these limits as defined in the Annexes of Directive 2011/65/EU (RoHS2). Finished electrical and electronic equipment products will be CE marked as required by Directive 2011/65/EU. Components may not be CE marked. Additionally, the part numbers that TE has identified as EU ELV compliant have a maximum concentration of 0.1% by weight in homogenous materials for lead, hexavalent chromium, and mercury, and 0.01% for cadmium, or qualify for an exemption to these limits as defined in the Annexes of Directive 2000/53/EC (ELV). Regarding the REACH Regulation, the information TE provides

on SVHC in articles for this part number is based on the latest European Chemicals Agency (ECHA) 'Guidance on requirements for substances in articles' posted at this URL: <https://echa.europa.eu/guidance-documents/guidance-on-reach>

Compatible Parts



TE Part # CAT-3984552-PHITPS
CT Post Header Assembly: Part. Shrouded



TE Part # CAT-AM7017-H342
AMP COMMON TERMINATION HEADERS



TE Part # CAT-3984552-BHTHVS
CT Box Header SMT: Vert, Shrouded



TE Part # CAT-3983178-PHBXVD
CT 2mm Post Header Asmbly: Box V DIP



TE Part # CAT-3980407-RHRRRA
CT 2mm Header Assembly: Right Angle



TE Part # CAT-3983174-PHBXHK
CT 2mm Post Header Assembly Box H Kink



TE Part # 6-292254-2
CT RELAY HDR ASSY 2P BLACK



TE Part # 58074-1
MTA 50/100/156 MANUAL TOOL FRAME



TE Part # 58372-1
HEAD (IDC) 2MM C.T. W/O TL



TE Part # 292164-2
CT P/HDR BOX H ASSY 2P T/P NAT



TE Part # 292165-2
CT P/HDR BOX V 2P T/P NAT



TE Part # CAT-3980408-PHDWKV
CT 2mm Post Header Assembly with Kink - Vertical



TE Part # 6-292156-2
CT RELAY HDR ASSY FREE HANGING



TE Part # 2-292164-2
CT P/HDR BOX H ASSY 2P T/P BLU



TE Part # 2-292165-2
CT P/HDR BOX V 2P T/P BLUE



TE Part # 4-292165-2
CT P/HDR BOX V 2P T/P YELLOW

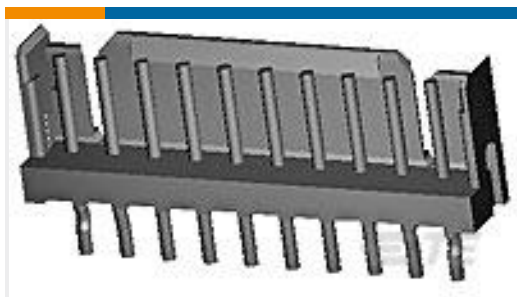

TE Part # 6-292145-2
CT P/HDR ASSY V 2P W/O KINK BL

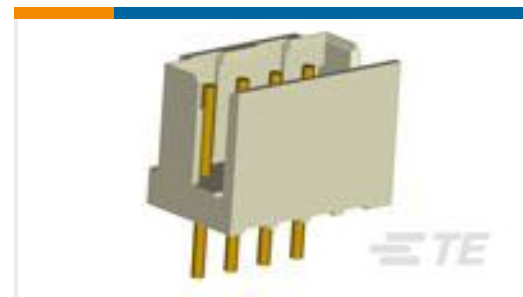

TE Part # 6-292165-2
CT P/HDR BOX V 2P T/P BLACK

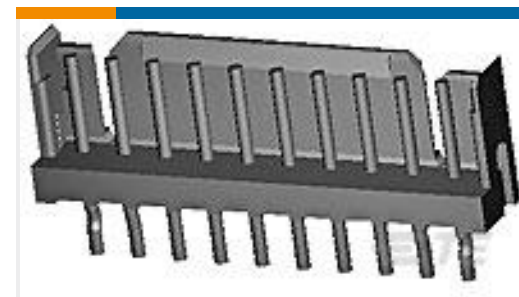

TE Part # 6-292170-2
CT P/HDR ASSY 2P V W/O KINK T



TE Part # 292254-2
CT RELAY HDR ASSY 2P NAT

Also in the Series | AMP CT

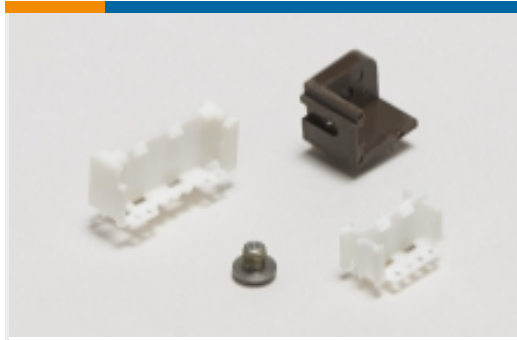

PCB Connector Mounting(46)

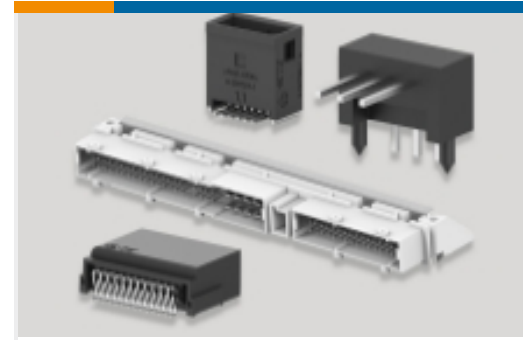

PCB Headers & Receptacles(756)

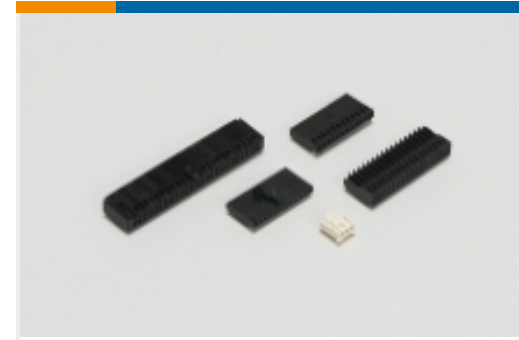

Wire-to-Board Connector Assemblies
& Housings(256)



Wire-to-Board Connector Contacts(8)

Customers Also Bought

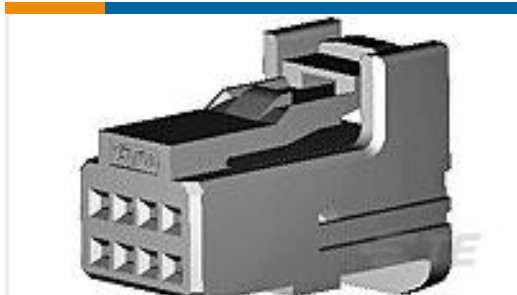

TE Part #1717109-1
0.64 III 16POS PLUG ASSY



TE Part #6-173977-3
CT CONN MT REC ASSY 3P BLACK



TE Part #179609-1
AMP CT CRIMP TTYPE-2 REC CONT.



TE Part #2-1879074-0
THS15 27R 5%

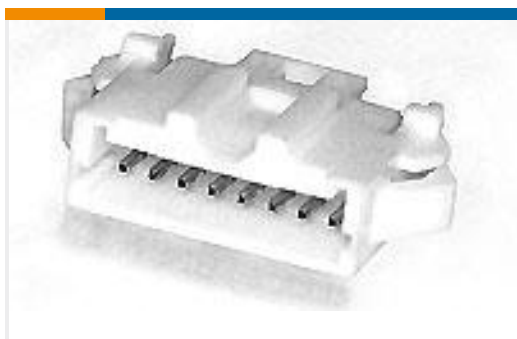

TE Part #292215-6
MINI CT SGL RELAY 6P NAT



TE Part #170043-2
110 FASTON,REC.,24-20 AWG,TPBR

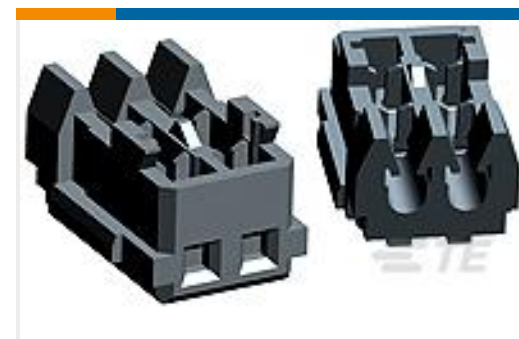

TE Part #353293-3
MINI CT MT REC ASSY 3P GRAY



TE Part #160173-2
FF 110 REC 22-20AWG TPBR



TE Part #1674311-7
0.64 III RCPT 3 Serrations Pre-Tin



Documents

CAD Files

Customer View Model

[ENG_CVM_CVM_6-173977-2_M.2d_dxf.zip](#)

English

3D PDF

3D

Customer View Model

[ENG_CVM_CVM_6-173977-2_M.3d_igs.zip](#)

English

Customer View Model

[ENG_CVM_CVM_6-173977-2_M.3d_stp.zip](#)

English

By downloading the CAD file I accept and agree to the [Terms and Conditions](#) of use.

Product Specifications

[Application Specification](#)

English

Product Environmental Compliance

[MD_6-173977-2_07072016147_dmtec](#)

English

[MD_6-173977-2_07072016147_dmtec](#)

English

Instruction Sheets

[MINI PRESS CT CONNECTOR \(WAS IS-553J\)](#)

Japanese

[Instruction Sheet \(non U.S.\)](#)

Japanese

Agency Approvals

[CSA Certificate](#)

English