

6-160449-3 ✓ ACTIVE

FASTIN-FASTON | FASTIN-FASTON 250

TE Internal #: 6-160449-3

Quick Disconnects, Receptacle, 17 – 13 AWG Wire Size, 1.03 – 2.62 mm<sup>2</sup> Wire Size, Mating Tab Width 6.35 mm [.25 in], Straight, FASTIN-FASTON 250

[View on TE.com >](#)



Terminals & Splices > Quick Disconnects

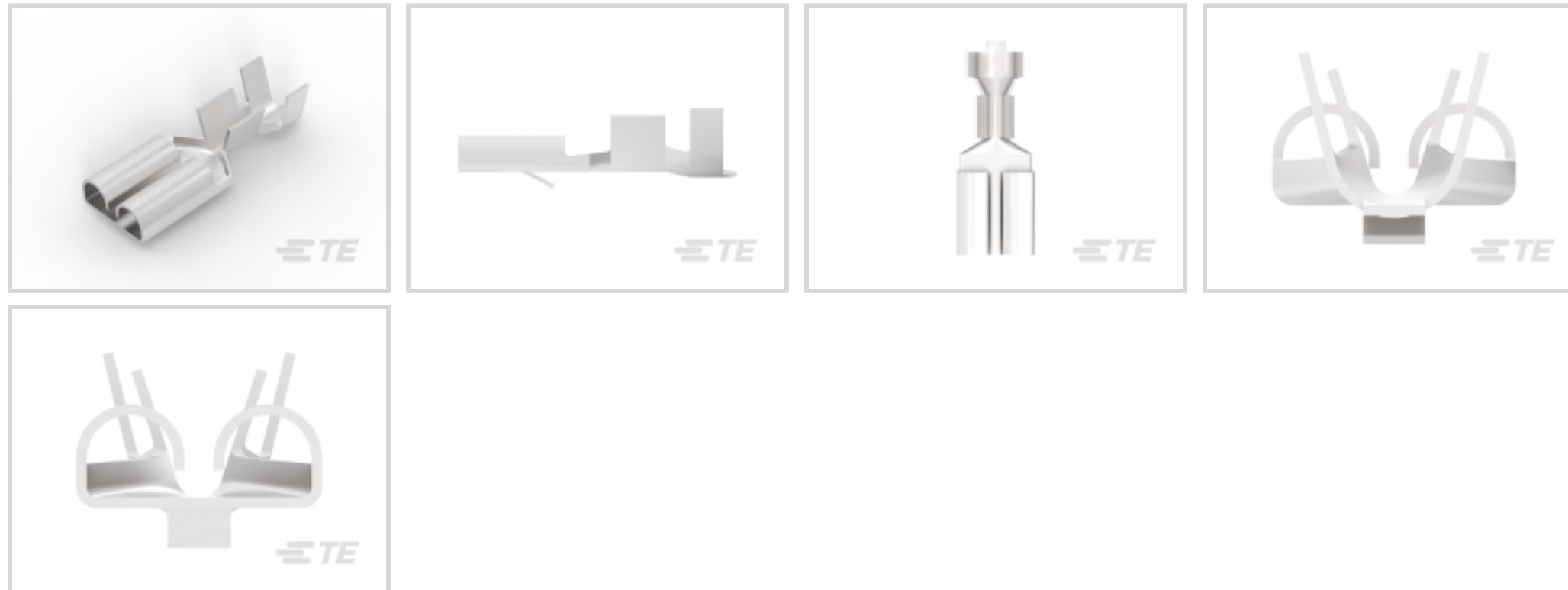

Quick Disconnect Terminal Type: **Receptacle**

Wire Size: **1.03 – 2.62 mm<sup>2</sup>**

Mating Tab Width: **6.35 mm [.25 in]**

Mating Tab Thickness: **.81 mm [.032 in]**

## Features

### Product Type Features

Insertion Force	Normal
-----------------	--------

### Configuration Features

Connection Capacity	Single
---------------------	--------

Compatible With Wire & Cable Type	Discrete Wire
-----------------------------------	---------------

### Contact Features

Quick Disconnect Terminal Type	Receptacle
--------------------------------	------------

Mating Tab Width	6.35 mm [.25 in]
------------------	------------------

Mating Tab Thickness	.81 mm [.032 in]
----------------------	------------------

Terminal Orientation	Straight
----------------------	----------

Contact Base Material	Phosphor Bronze
-----------------------	-----------------

Terminal Plating Material	Silver
---------------------------	--------

Crimp Type	F-Crimp
------------	---------

Barrel Type	Open
-------------	------

### Termination Features



Product Terminates To	Wire & Cable
-----------------------	--------------

### Mechanical Attachment

Locking Lance Height	1.2 mm[.05 in]
----------------------	----------------

Wire Insulation Support	With
-------------------------	------

Mating Retention Type	Locking Lance
-----------------------	---------------

### Dimensions

Terminal Material Thickness	.33 mm[.013 in]
-----------------------------	-----------------

Product Length	19.2 mm[.755 in]
----------------	------------------

Compatible Insulation Diameter Range	3.43 – 5.08 mm[.135 – .2 in]
--------------------------------------	------------------------------

Wire Size	1.03 – 2.62 mm <sup>2</sup>
-----------	-----------------------------

### Usage Conditions

Insulation Option	Uninsulated
-------------------	-------------

Operating Temperature Range	-40 – 130 °C[-40 – 266 °F]
-----------------------------	----------------------------

### Packaging Features

Packaging Quantity	500
--------------------	-----

Packaging Method	Loose Piece/Carton
------------------	--------------------

### Other

Line	FASTON .250
------	-------------

## Product Compliance

[For compliance documentation, visit the product page on TE.com>](#)

EU RoHS Directive 2011/65/EU	Compliant
------------------------------	-----------

EU ELV Directive 2000/53/EC	Compliant
-----------------------------	-----------

China RoHS 2 Directive MIIT Order No 32, 2016	No Restricted Materials Above Threshold
---	---

EU REACH Regulation (EC) No. 1907/2006	Current ECHA Candidate List: JUNE 2023 (235) Candidate List Declared Against: JUNE 2023 (235) Does not contain REACH SVHC
--	---

Halogen Content	Low Halogen - Br, Cl, F, I < 900 ppm per homogenous material. Also BFR/CFR/PVC Free
-----------------	---

Solder Process Capability	Not applicable for solder process capability
---------------------------	--

Product Compliance Disclaimer

This information is provided based on reasonable inquiry of our suppliers and represents our current actual knowledge based on the information they provided. This information is subject to change. The part numbers that TE has identified as EU RoHS compliant have a maximum concentration of 0.1% by weight in homogenous materials for lead, hexavalent chromium, mercury, PBB, PBDE, DBP, BBP, DEHP, DIBP, and 0.01% for cadmium, or qualify for an exemption to these limits as defined in the Annexes of Directive 2011/65/EU (RoHS2). Finished electrical and electronic equipment products will be CE marked as required by Directive 2011/65/EU. Components may not be CE marked. Additionally, the part numbers that TE has identified as EU ELV compliant have a maximum concentration of 0.1% by weight in homogenous materials for lead, hexavalent chromium, and mercury, and 0.01% for cadmium, or qualify for an exemption to these limits as defined in the Annexes of Directive 2000/53/EC (ELV). Regarding the REACH Regulation, the information TE provides on SVHC in articles for this part number is based on the latest European Chemicals Agency (ECHA) 'Guidance on requirements for substances in articles' posted at this URL: <https://echa.europa.eu/guidance-documents/guidance-on-reach>

## Compatible Parts



## Also in the Series | FASTIN-FASTON 250

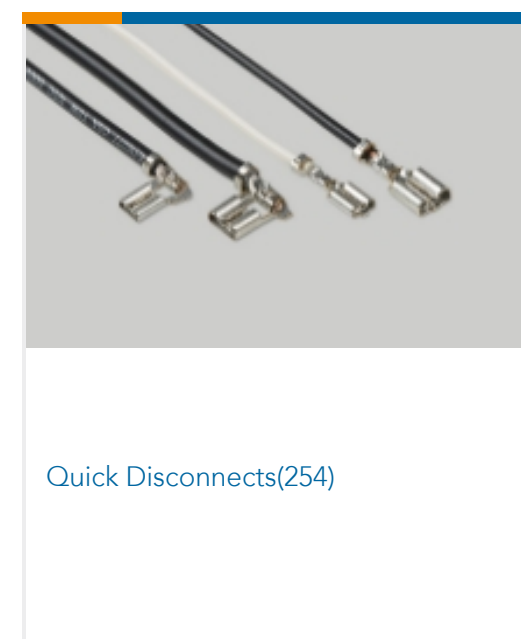
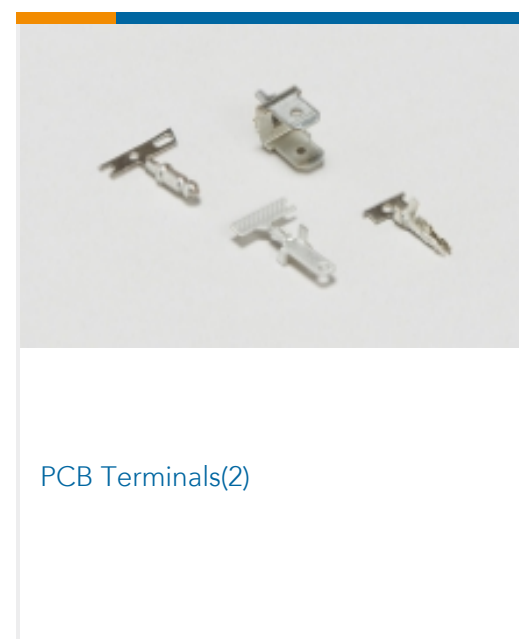
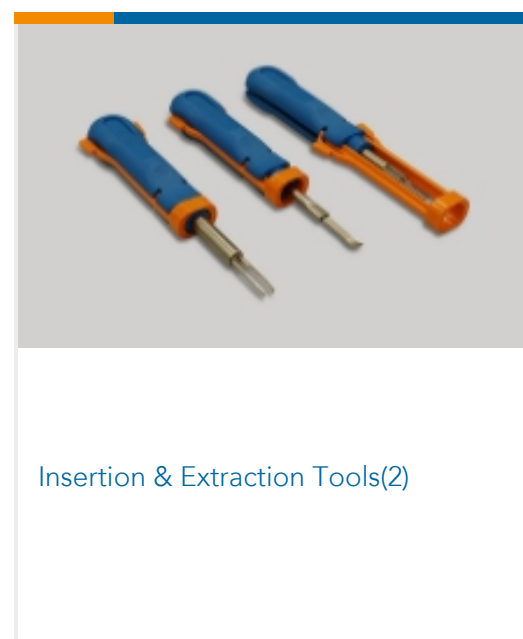
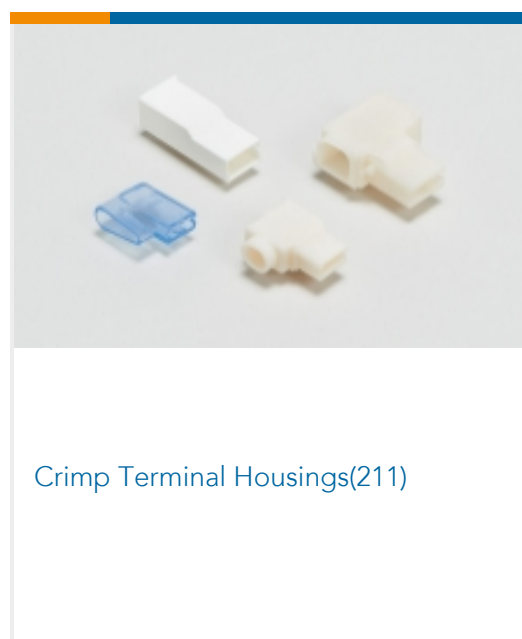

## Customers Also Bought

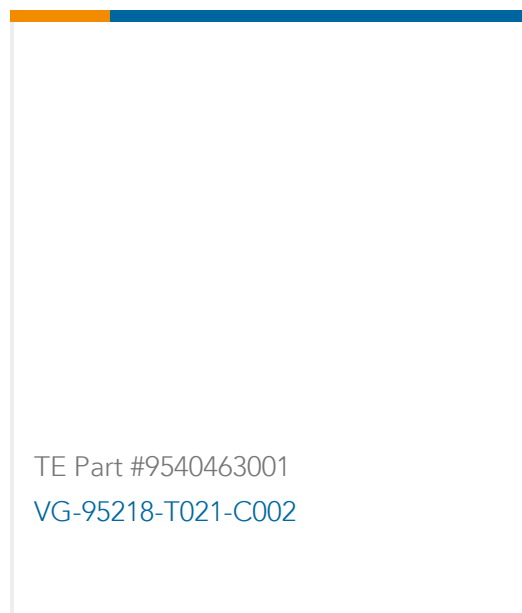
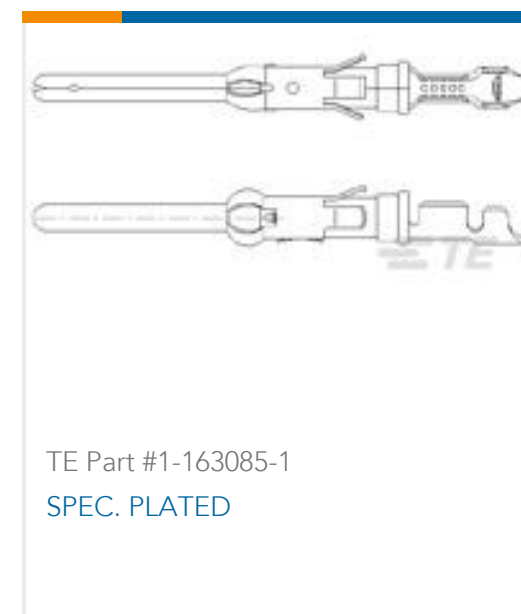

## Documents

### Product Drawings

[FF 250 REC 1-2.5MM2 PB SILVER PLATED LP](#)

English

### CAD Files

[3D PDF](#)

3D

Customer View Model

[ENG\\_CVM\\_CVM\\_6-160449-3\\_U.2d\\_dxf.zip](#)

English

Customer View Model

[ENG\\_CVM\\_CVM\\_6-160449-3\\_U.3d\\_igs.zip](#)

English

Customer View Model

[ENG\\_CVM\\_CVM\\_6-160449-3\\_U.3d\\_stp.zip](#)

English

By downloading the CAD file I accept and agree to the [Terms and Conditions](#) of use.