

5646489-1 ✓ ACTIVE

Z-PACK | Z-PACK 2mm HM

TE Internal #: 5646489-1

Hard Metric Backplane Connectors, PCB Mount Receptacle, ≤ 1 Gb

/s, 22 Column, 5 Row, Mezzanine, 110 Position, 2 mm [.078 in]

Centerline, Z-PACK 2mm HM

[View on TE.com >](#)



[Connectors >](#) [PCB Connectors >](#) [Backplane Connectors >](#) [Hard Metric Backplane Connectors >](#)

HM Receptacle Connector: Traditional Backplane, Coplanar, 2mm



PCB Connector Assembly Type: **PCB Mount Receptacle**

Data Rate: ≤ 1 Gb/s

Number of Columns: **22**

Number of Rows: **5**

Backplane Architecture: **Mezzanine**

[All HM Receptacle Connector: Traditional Backplane, Coplanar, 2mm \(48\)](#)

Features

Product Type Features

Backplane Interface Type	2mm HM
PCB Connector Assembly Type	PCB Mount Receptacle
Connector System	Board-to-Board
Sealable	No
Connector & Contact Terminates To	Printed Circuit Board

Configuration Features

Rows Loaded	A, B, C, D, E
Number of Signal Positions	125
Number of Columns	22
Number of Rows	5
Backplane Architecture	Mezzanine
Number of Positions	110
PCB Mount Orientation	Right Angle

Signal Characteristics

Crosstalk Version	Standard
Data Rate	≤ 1 Gb/s



Body Features

Primary Product Color	Gray
-----------------------	------

Contact Features

Feedthrough Post Length	3.3 mm
CompactPCI Designation	None
Contact Type	Socket
Contact Underplating Material	Nickel
PCB Contact Termination Area Plating Material	Tin
Contact Base Material	Phosphor Bronze
Contact Mating Area Plating Material	Performance Based
Contact Mating Area Plating Material Thickness	.76 μm[30 μin]
Contact Current Rating (Max)	1.5 A

Mechanical Attachment

Front Mating Level	Level 1
Mating Alignment Type	Multi-Purpose Center
Connector Mounting Type	Board Mount

Housing Features

Housing Material	Polyester - GF
Centerline (Pitch)	2 mm[.078 in]

Dimensions

Backplane Module Length	44 mm
-------------------------	-------

Usage Conditions

Operating Temperature Range	-55 – 125 °C[-67 – 257 °F]
-----------------------------	----------------------------

Operation/Application

Shielded	Yes
Circuit Application	Signal

Industry Standards

UL Flammability Rating	UL 94V-0
------------------------	----------

Packaging Features

Packaging Quantity	10
Packaging Method	Tube

Product Compliance

[For compliance documentation, visit the product page on TE.com>](#)

EU RoHS Directive 2011/65/EU	Compliant
EU ELV Directive 2000/53/EC	Compliant
China RoHS 2 Directive MIIT Order No 32, 2016	No Restricted Materials Above Threshold
EU REACH Regulation (EC) No. 1907/2006	Current ECHA Candidate List: JUNE 2023 (235) Candidate List Declared Against: JUNE 2023 (235) Does not contain REACH SVHC
Halogen Content	Not Low Halogen - contains Br or Cl > 900 ppm.
Solder Process Capability	Not applicable for solder process capability

Product Compliance Disclaimer

This information is provided based on reasonable inquiry of our suppliers and represents our current actual knowledge based on the information they provided. This information is subject to change. The part numbers that TE has identified as EU RoHS compliant have a maximum concentration of 0.1% by weight in homogenous materials for lead, hexavalent chromium, mercury, PBB, PBDE, DBP, BBP, DEHP, DIBP, and 0.01% for cadmium, or qualify for an exemption to these limits as defined in the Annexes of Directive 2011/65/EU (RoHS2). Finished electrical and electronic equipment products will be CE marked as required by Directive 2011/65/EU. Components may not be CE marked. Additionally, the part numbers that TE has identified as EU ELV compliant have a maximum concentration of 0.1% by weight in homogenous materials for lead, hexavalent chromium, and mercury, and 0.01% for cadmium, or qualify for an exemption to these limits as defined in the Annexes of Directive 2000/53/EC (ELV). Regarding the REACH Regulation, the information TE provides on SVHC in articles for this part number is based on the latest European Chemicals Agency (ECHA) 'Guidance on requirements for substances in articles' posted at this URL: <https://echa.europa.eu/guidance-documents/guidance-on-reach>

Compatible Parts

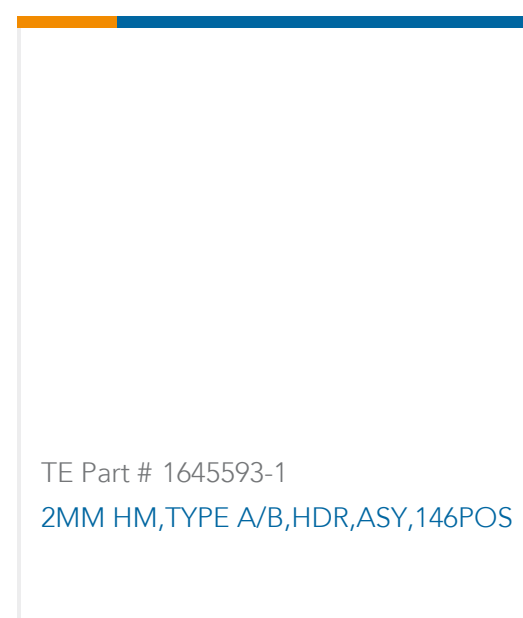

Also in the Series | [Z-PACK 2mm HM](#)

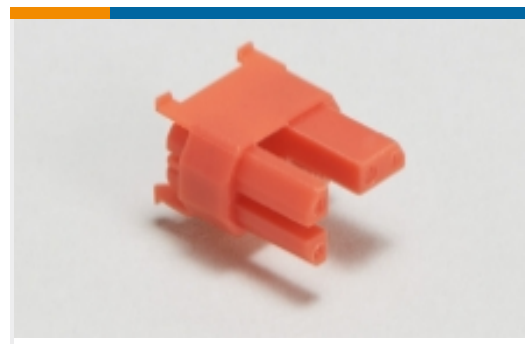

Backplane Coding Keys(60)

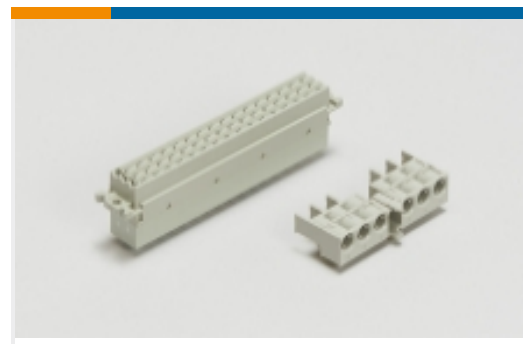

Backplane Connector Housings(4)



Backplane Guide Hardware(37)

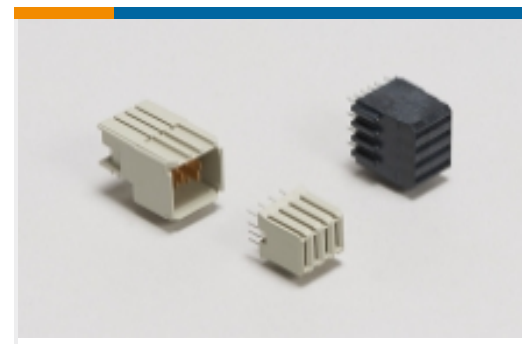

Backplane Power Connectors(6)



Board-to-Board Connector Contacts(2)

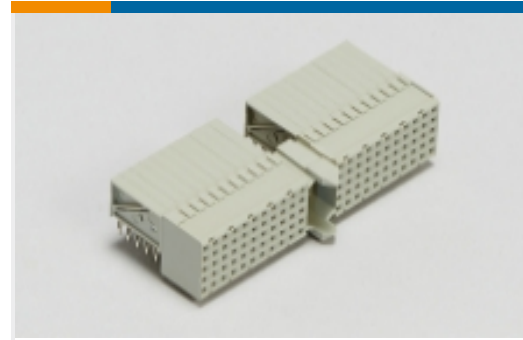

Hard Metric Backplane Connectors (269)

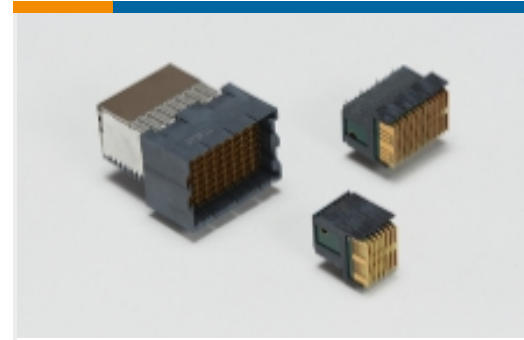

High Speed Backplane Connectors(1)



Insertion & Extraction Tools(2)

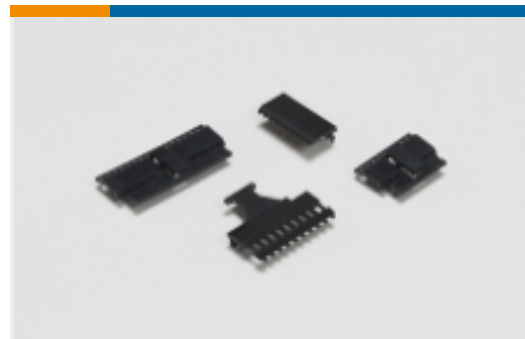

PCB Connector Covers(4)



PCB Connector Shrouds(39)



PCB Ferrules & Shields(19)



Rectangular Power Connectors(87)

Customers Also Bought



TE Part #5749621-5
50 50S CABLE PLUG CONN/COV KIT

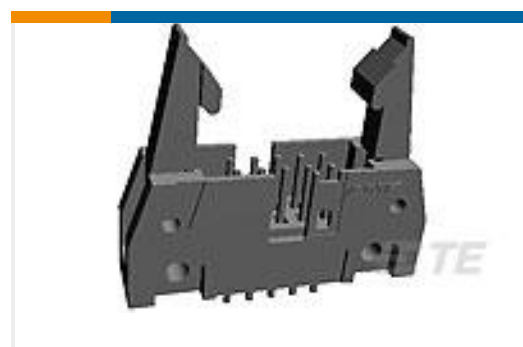

TE Part #5102321-3
A/L UNIV HDR 16P VERT LG LAT



TE Part #1-6609987-4
15SRB8-W=F8220D



TE Part #3-1879071-2
THS50 39R 5%



TE Part #1982295-2
ELCON MINI 2P RA HEADER,W/O CODING

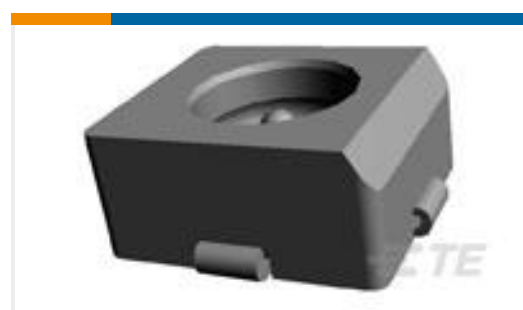

TE Part #1055687-1
2367 0000 54, VERT PLUG



TE Part #4-1415535-9
PE034012

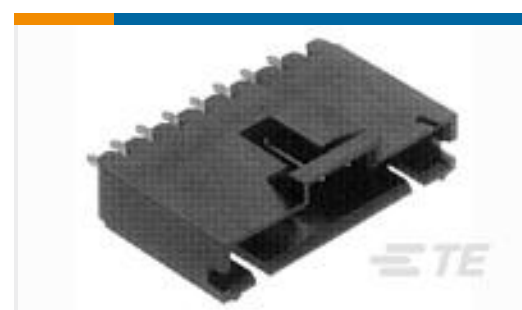

TE Part #5-103639-9
10 MTE HDR SRST LATCH .100CL



Documents

Product Drawings

[2MM H.M. A/B-22 RECEPT. ASSY.](#)

English

CAD Files

[3D PDF](#)

3D

Customer View Model

[ENG_CVM_CVM_5646489-1_A.2d_dxf.zip](#)

English

Customer View Model

[ENG_CVM_CVM_5646489-1_A.3d_igs.zip](#)

English

Customer View Model

[ENG_CVM_CVM_5646489-1_A.3d_stp.zip](#)

English

By downloading the CAD file I accept and agree to the [Terms and Conditions](#) of use.

Product Specifications

[Application Specification](#)

English

Product Environmental Compliance

[MD_5646489-1_10132017428_dmtec](#)

English

[MD_5646489-1_10132017428_dmtec](#)

English