

5535032-5 ✓ ACTIVE

EUROCARD

TE Internal #: 5535032-5

Eurocard Connectors, Receptacle, Board-to-Board, 96 Position, .1 in [2.54 mm] Centerline, Printed Circuit Board, 3 Row, Vertical, 32 Column

[View on TE.com >](#)



Connectors > PCB Connectors > Backplane Connectors > Eurocard Connectors

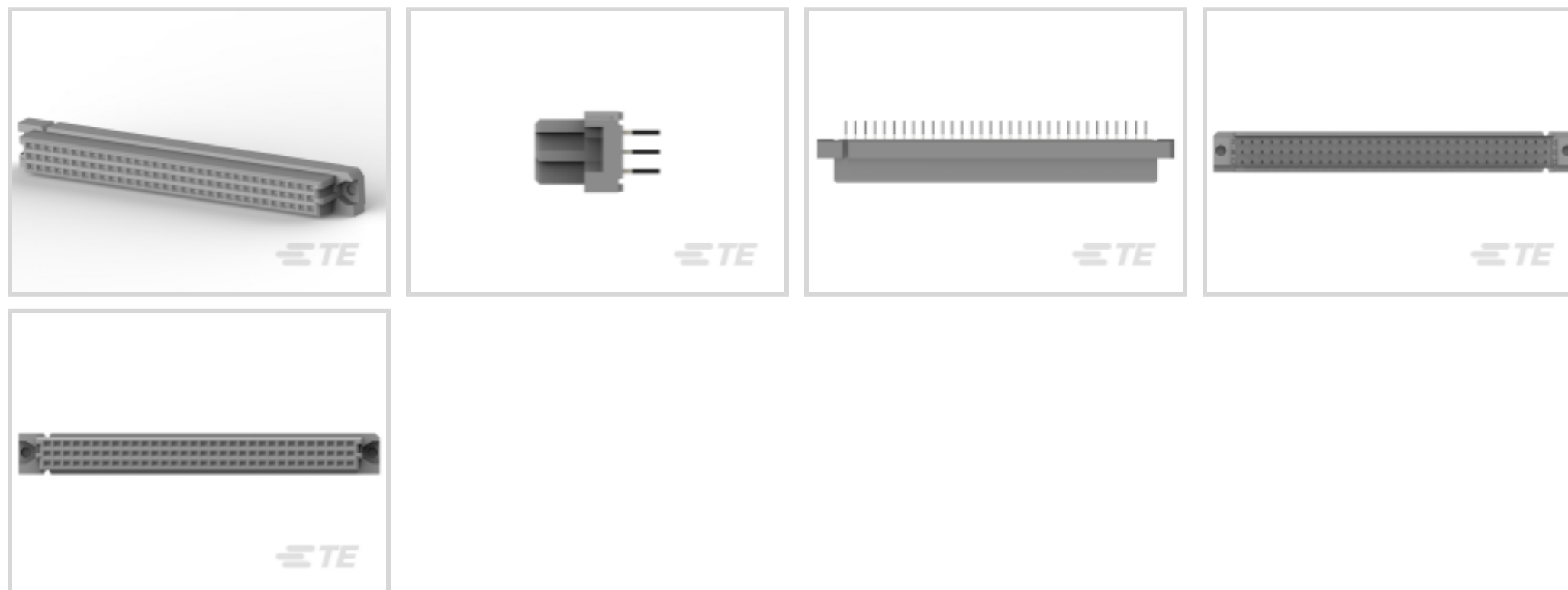

Connector & Housing Type: **Receptacle**

Connector System: **Board-to-Board**

Termination Post & Tail Length: **4.83 mm [.19 in]**

Number of Positions: **96**

Centerline (Pitch): **2.54 mm [.1 in]**

Features

Product Type Features

Connector & Housing Type	Receptacle
Connector System	Board-to-Board
Connector & Contact Terminates To	Printed Circuit Board
DIN Size	Standard
DIN Level	II

Configuration Features

Number of Positions	96
Number of Rows	3
PCB Mount Orientation	Vertical
Number of Columns	32
Number of Signal Positions	96
Rows Loaded	A, B, C

Contact Features

PCB Contact Termination Area Plating Material	Tin
---	-----



Termination Features

Termination Post & Tail Length	4.83 mm[.19 in]
--------------------------------	-----------------

Mechanical Attachment

Connector Mounting Type	Board Mount
-------------------------	-------------

Housing Features

Centerline (Pitch)	2.54 mm[.1 in]
--------------------	----------------

Dimensions

Row-to-Row Spacing	2.54 mm[.1 in]
--------------------	----------------

Usage Conditions

Operating Temperature Range	-55 – 105 °C[-67 – 221 °F]
-----------------------------	----------------------------

Operation/Application

Circuit Application	Signal
---------------------	--------

Product Compliance

[For compliance documentation, visit the product page on TE.com>](#)

EU RoHS Directive 2011/65/EU	Compliant
EU ELV Directive 2000/53/EC	Compliant
China RoHS 2 Directive MIIT Order No 32, 2016	No Restricted Materials Above Threshold
EU REACH Regulation (EC) No. 1907/2006	Current ECHA Candidate List: JUNE 2023 (235) Candidate List Declared Against: JUNE 2023 (235) Does not contain REACH SVHC
Halogen Content	Not Low Halogen - contains Br or Cl > 900 ppm.
Solder Process Capability	Not applicable for solder process capability

Product Compliance Disclaimer

This information is provided based on reasonable inquiry of our suppliers and represents our current actual knowledge based on the information they provided. This information is subject to change. The part numbers that TE has identified as EU RoHS compliant have a maximum concentration of 0.1% by weight in homogenous materials for lead, hexavalent chromium, mercury, PBB, PBDE, DBP, BBP, DEHP, DIBP, and 0.01% for cadmium, or qualify for an exemption to these limits as defined in the Annexes of Directive 2011/65/EU (RoHS2). Finished electrical and electronic equipment products will be CE marked as required by Directive 2011/65/EU. Components may not be CE marked. Additionally, the part numbers that TE has identified as EU ELV compliant have a maximum concentration of 0.1% by weight in homogenous materials for lead, hexavalent chromium, and mercury, and 0.01% for cadmium, or qualify for an exemption to these limits as defined in the Annexes of Directive 2000/53/EC (ELV). Regarding the REACH Regulation, the information TE provides on SVHC in articles for this part number is based on the latest European Chemicals Agency (ECHA) 'Guidance on requirements for substances in articles' posted at this URL: <https://echa.europa.eu/guidance-documents/guidance-on-reach>

Compatible Parts

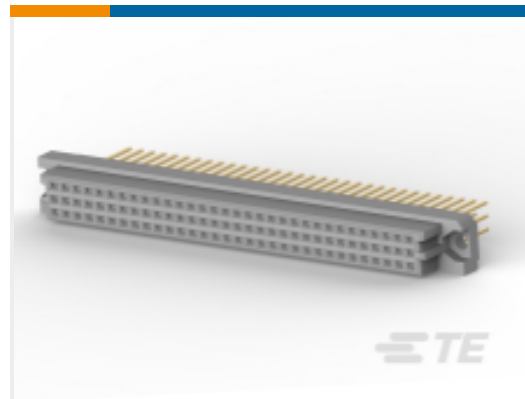

TE Part # 1-148057-5
096 EURO TYP C RECP 13MM ASSY



TE Part # 5535089-5
ASSEMBLY,RECEPTACLE,EUROCARD, T



TE Part # 650473-5
096 EURO TYPE C PIN ST ASSY

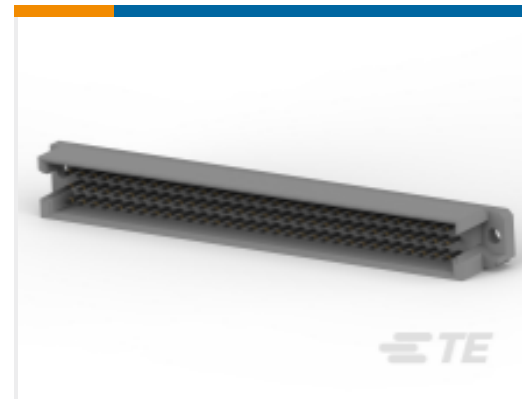

TE Part # 5650908-5
ASSY,PIN,EUROCARD,TYPE R,LEAD-

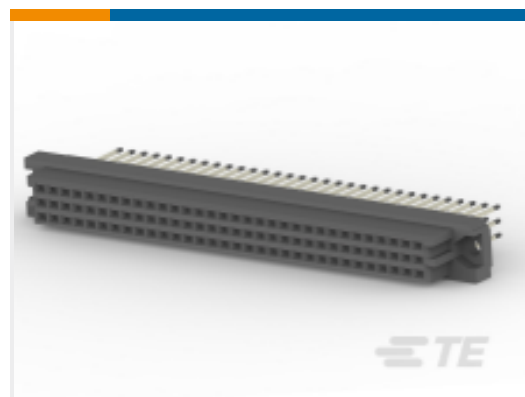

TE Part # 5148057-5
ASSY,RECEPTACLE,EUROCARD,TYPE C,LEAD-FRE

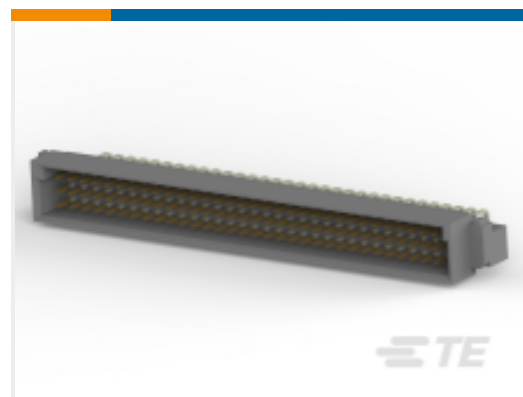

TE Part # 5650473-5
ASSY,PIN,EUROCARD,TYPE C,LEAD-



TE Part # 650947-5
096 EURO TYPE C PIN ST ASSY

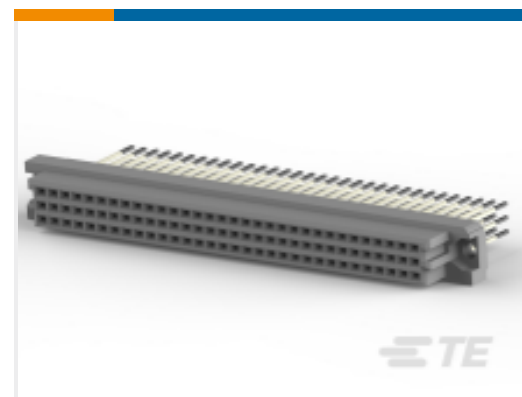

TE Part # 5148059-5
ASSY,RECEPTACLE,EUROCARD,TYPE C,LEAD-FRE

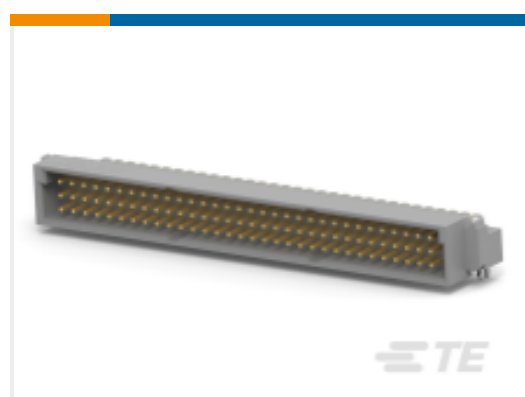

TE Part # 5536405-5
ASSY,PIN,EUROCARD,TYPE C,LEAD-



TE Part # 9-1393644-1
V42254B1200C960=PC612 MESSERLE

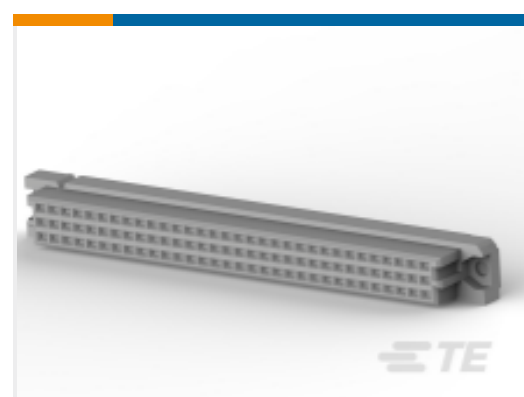

TE Part # 5535090-5
ASSEMBLY,RECEPTACLE,EUROCARD, T



TE Part # 1-1393644-6
V42254B1100C960=PC612 MESSERLE



TE Part # 650913-5
096 EURO TYPE C PIN BL ASSY

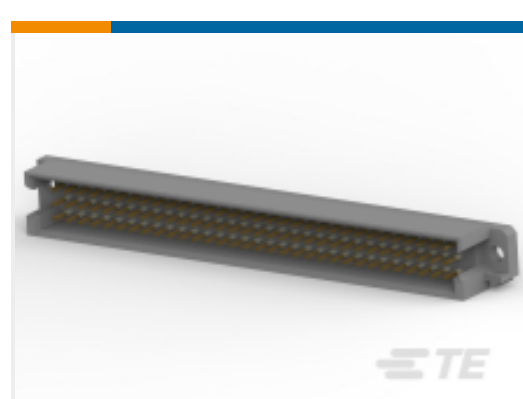

TE Part # 5650470-5
ASSY,PIN,EUROCARD,TYPE R,LEAD-

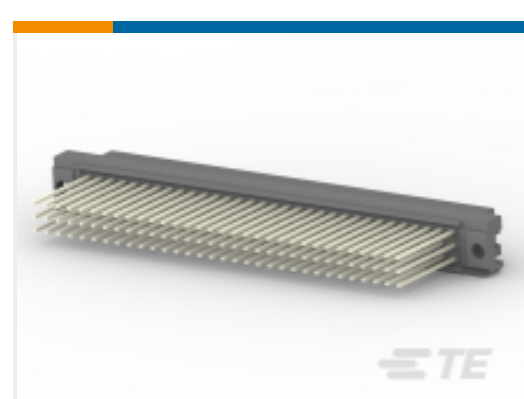

TE Part # 1-148059-5
096 EURO TYP C RECP 17MM ASSY

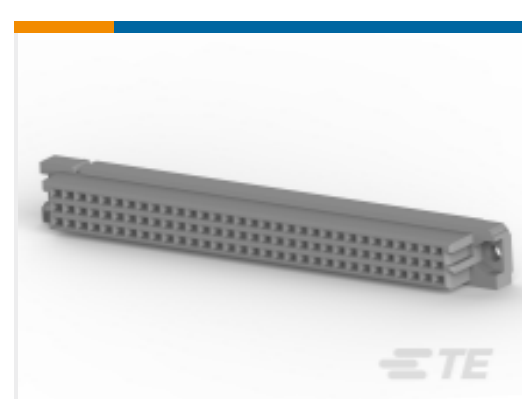

TE Part # 535032-4
096 EURO TYPE C RECEPT AP ASSY

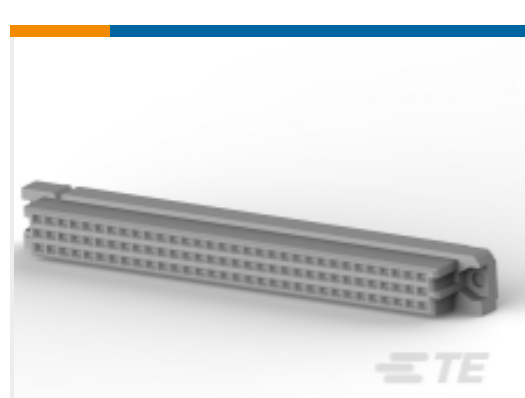

TE Part # 5535032-4
ASSY,RECEPTACLE,EUROCARD,TYPE

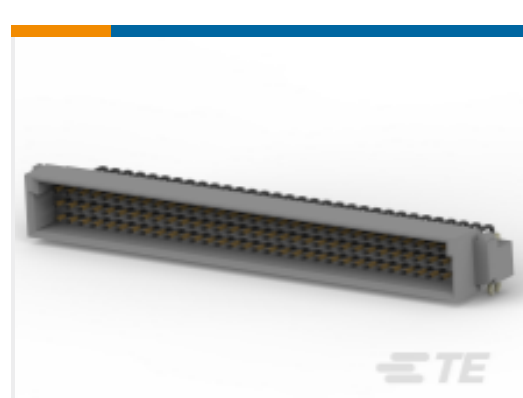

TE Part # 5650913-5
ASSY,PIN,EUROCARD,TYPE C,LEAD-

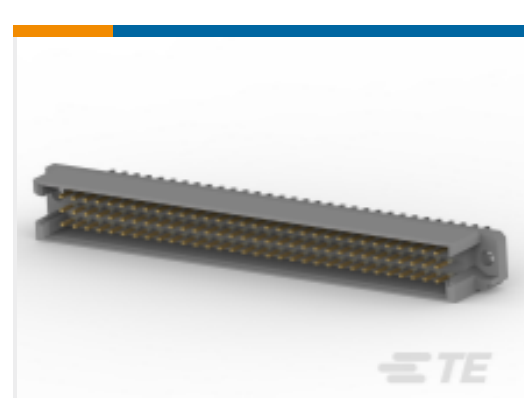

TE Part # 5650889-5
ASSY,PIN,EUROCARD,TYPE R,LEAD-

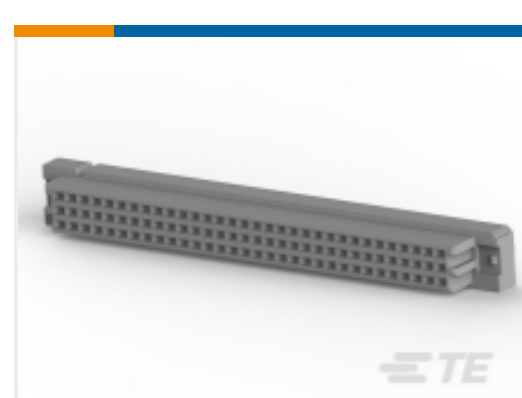

TE Part # 5650963-5
ASSY,RECEPTACLE,EUROCARD,TYPE

Customers Also Bought

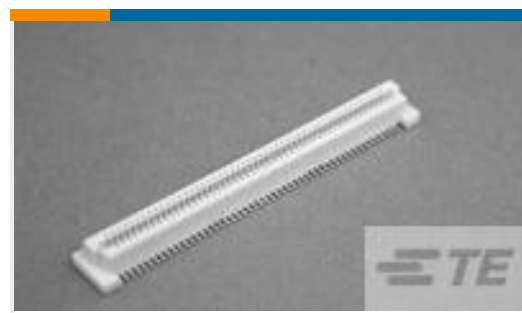

TE Part #1735482-1
0.8FH,R17H.5,040,08/Sn,TR,SC

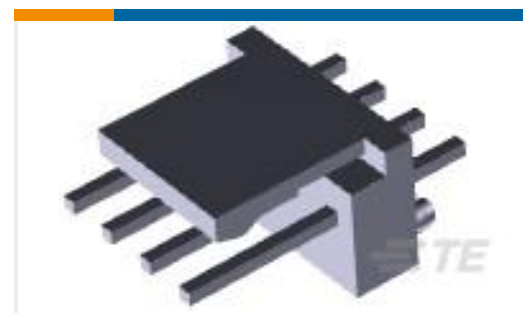

TE Part #3-647609-4
04P MTA100 HDR ASSY F/L LF

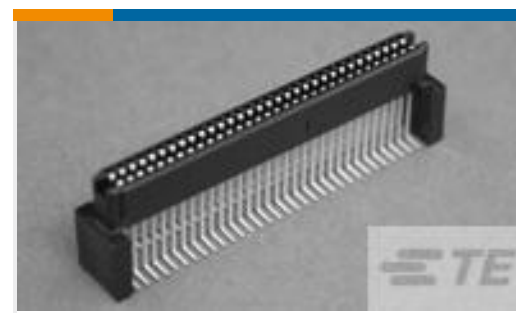

TE Part #120524-1
1FHR,64,30A/P,S,N,S14,15



TE Part #5747843-3
37 MSFL PLUG RA 318 (IN,FM,BL)



TE Part #1-770170-1
03P MINI UMNL ASSY VO SNAU LF

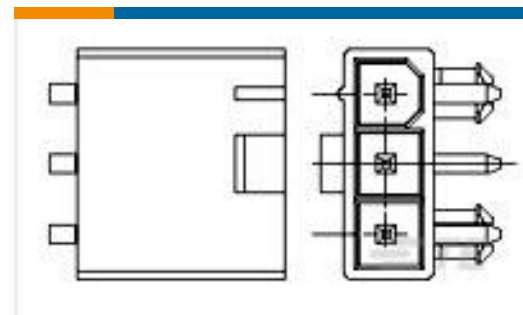

TE Part #2029150-5
5P R/A HDR VAL-U-LOK V2 W/P



TE Part #650983-5
064 EURO TYPE C RECEPT BL ASSY

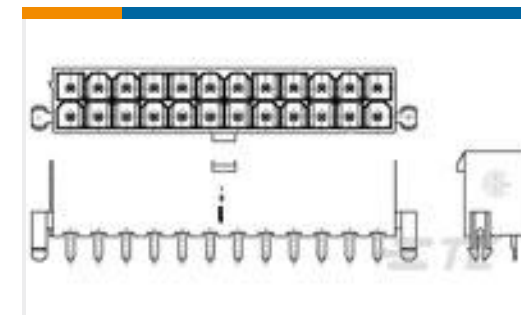

TE Part #1586040-8
8P VAL-U-LOK VRT HDR W/P V0

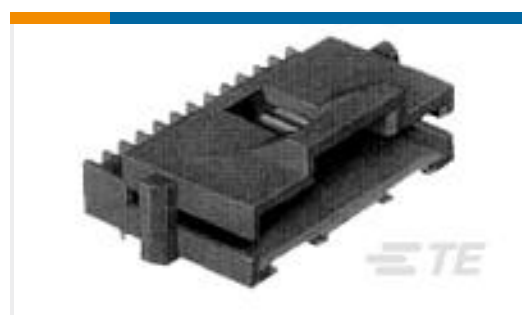

TE Part #104074-4
20 SYSTEM 50 HDR SRRA SHRD



TE Part #650963-5
096 EURO TYPE C RECEPT BL ASSY

Documents

Product Drawings

ASSY,RECEPTACLE,EUROCARD,TYPE C,LEAD-FRE

English

CAD Files

3D PDF

3D

Customer View Model

[ENG_CVM_CVM_5535032-5_A.2d_dxf.zip](#)

English

Customer View Model

[ENG_CVM_CVM_5535032-5_A.3d_igs.zip](#)

English

Customer View Model

[ENG_CVM_CVM_5535032-5_A.3d_stp.zip](#)

English

By downloading the CAD file I accept and agree to the [Terms and Conditions](#) of use.

Product Specifications



Application Specification

English

Product Environmental Compliance

TE Material Declaration

English