

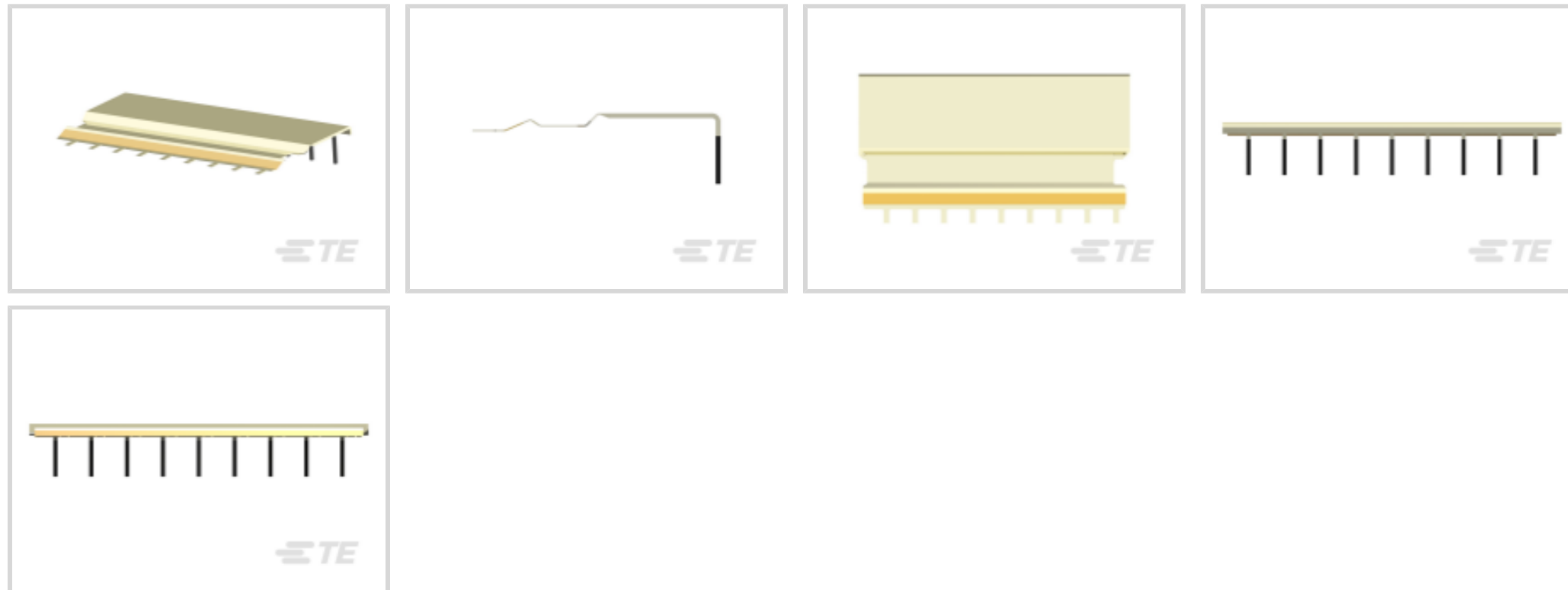

Connectors > Connector Accessories > Connector Caps & Covers



Connector Cover Type: **Shield (Lower)**

Features

Product Type Features

Ground Feature Type	Ground Return Shielding
Connector Cover Type	Shield (Lower)

Packaging Features

Packaging Quantity	30
--------------------	----

Other

Connector Accessory Comment	For use with Right Angle Female Connectors, 5 Row, Type B 19 Col., Shields are supplied and fitted separately as required.
-----------------------------	--

Product Compliance

[For compliance documentation, visit the product page on TE.com>](#)

EU RoHS Directive 2011/65/EU	Compliant
EU ELV Directive 2000/53/EC	Compliant
China RoHS 2 Directive MIIT Order No 32, 2016	No Restricted Materials Above Threshold
EU REACH Regulation (EC) No. 1907/2006	Current ECHA Candidate List: JUNE 2023 (235) Candidate List Declared Against: JUNE 2023 (235) Does not contain REACH SVHC
Halogen Content	Low Halogen - Br, Cl, F, I < 900 ppm per

homogenous material. Also BFR/CFR/PVC Free

Solder Process Capability

Not applicable for solder process capability

Product Compliance Disclaimer

This information is provided based on reasonable inquiry of our suppliers and represents our current actual knowledge based on the information they provided. This information is subject to change. The part numbers that TE has identified as EU RoHS compliant have a maximum concentration of 0.1% by weight in homogenous materials for lead, hexavalent chromium, mercury, PBB, PBDE, DBP, BBP, DEHP, DIBP, and 0.01% for cadmium, or qualify for an exemption to these limits as defined in the Annexes of Directive 2011/65/EU (RoHS2). Finished electrical and electronic equipment products will be CE marked as required by Directive 2011/65/EU. Components may not be CE marked. Additionally, the part numbers that TE has identified as EU ELV compliant have a maximum concentration of 0.1% by weight in homogenous materials for lead, hexavalent chromium, and mercury, and 0.01% for cadmium, or qualify for an exemption to these limits as defined in the Annexes of Directive 2000/53/EC (ELV). Regarding the REACH Regulation, the information TE provides on SVHC in articles for this part number is based on the latest European Chemicals Agency (ECHA) 'Guidance on requirements for substances in articles' posted at this URL: <https://echa.europa.eu/guidance-documents/guidance-on-reach>

Compatible Parts

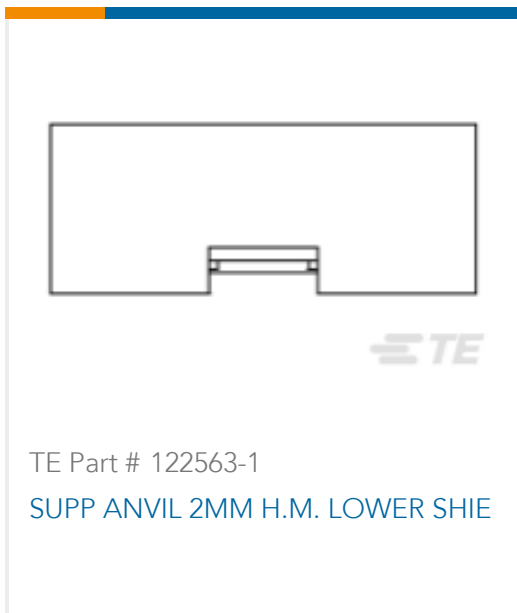

Also in the Series | Z-PACK 2mm HM

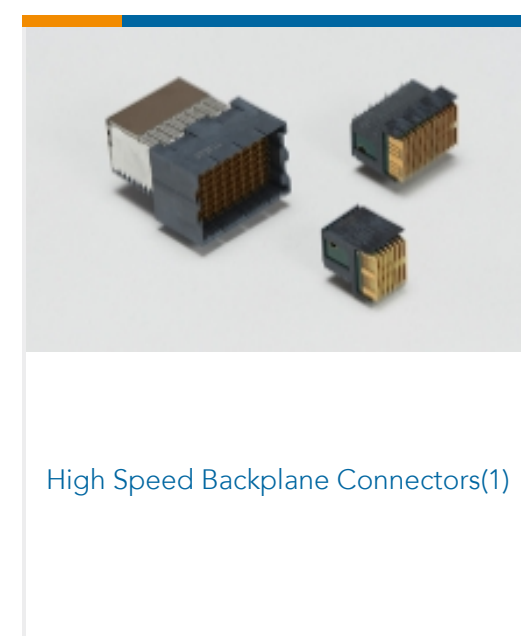
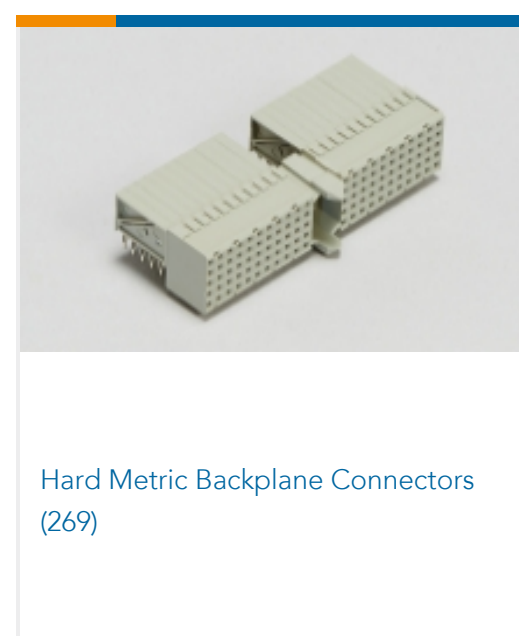
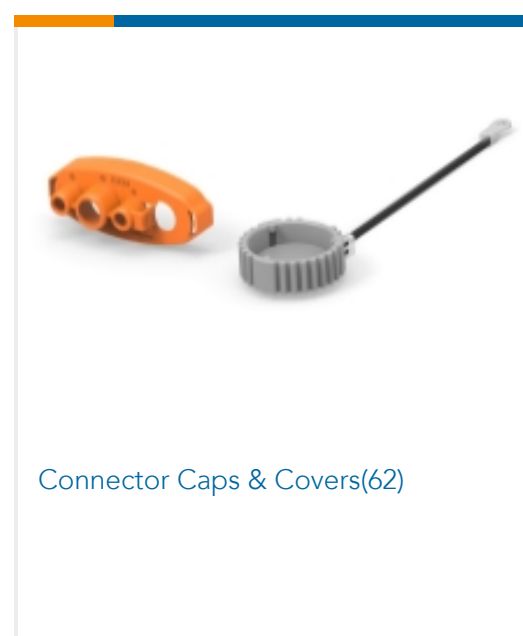
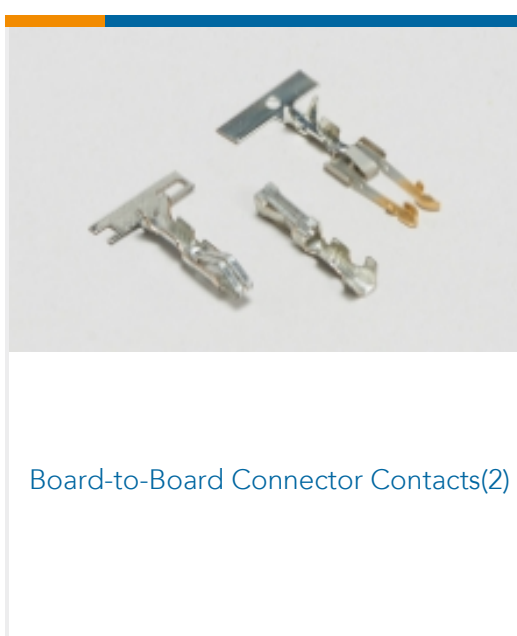
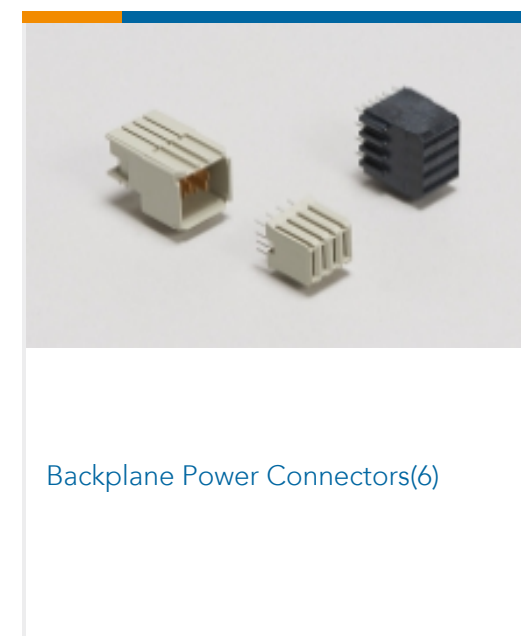
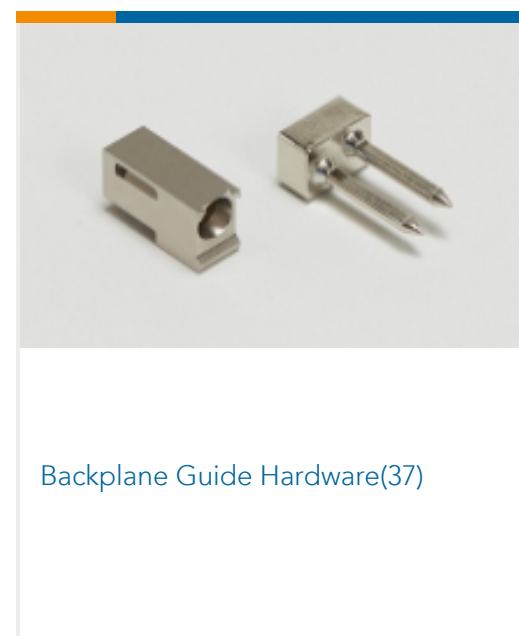
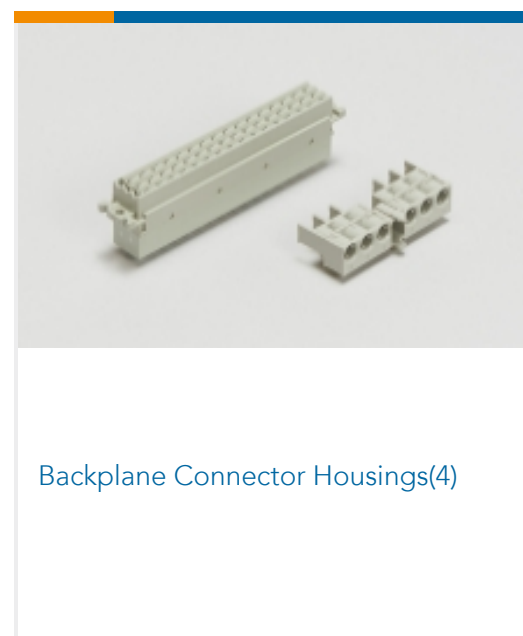
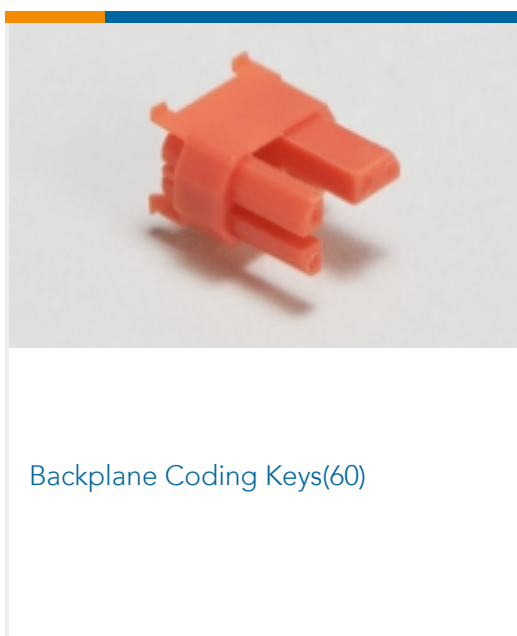



Insertion & Extraction Tools(2)



Rectangular Power Connectors(87)

Customers Also Bought



TE Part #2-320861-1
TERMINAL,PIDG SPD FLG 16-14 6



TE Part #5557484-1
MJ,TE,8P,SHLD,LOW PNL STR



TE Part #53126-1
TERMINAL,SOLIS SPR SPD 12-10 6



TE Part #5-1393117-3
KUP-11D35-24=KU



TE Part #292801-000
RNF-100-1-BK-FSP



TE Part #66405-4
III+ SKT,30-26,30AU/FL,LP



TE Part #1-794616-8
FREE HANG DBL ROW HSG 18 POS



TE Part #1776293-8
TSB23008DS=EUROPA TERM BLK, 8MM



TE Part #5053034137
RNF-100-1/8-WH-SP

Documents

[Product Drawings](#)
[Z-PACK SHLD LOWER B](#)

English

CAD Files

[3D PDF](#)

3D

[Customer View Model](#)

[ENG_CVM_CVM_5352029-2_B.2d_dxf.zip](#)



English

Customer View Model

[ENG_CVM_CVM_5352029-2_B.3d_igs.zip](#)

English

Customer View Model

[ENG_CVM_CVM_5352029-2_B.3d_stp.zip](#)

English

By downloading the CAD file I accept and agree to the [Terms and Conditions](#) of use.

Product Specifications

[Application Specification](#)

English

Product Environmental Compliance

[TE Material Declaration](#)

English