

53426-1 ✓ ACTIVE



PIDG

TE Internal #: 53426-1

Closed Ring Tongue Terminal, 12 – 10 AWG, 1/4 / M6 Stud Size, 6.73 mm [.265 in] Stud Diameter, Closed Barrel, Straight, Tin-Lead, PIDG

[View on TE.com >](#)

Terminals & Splices > Ring Terminals > PIDG Radiation Resistant C Rings/Spades

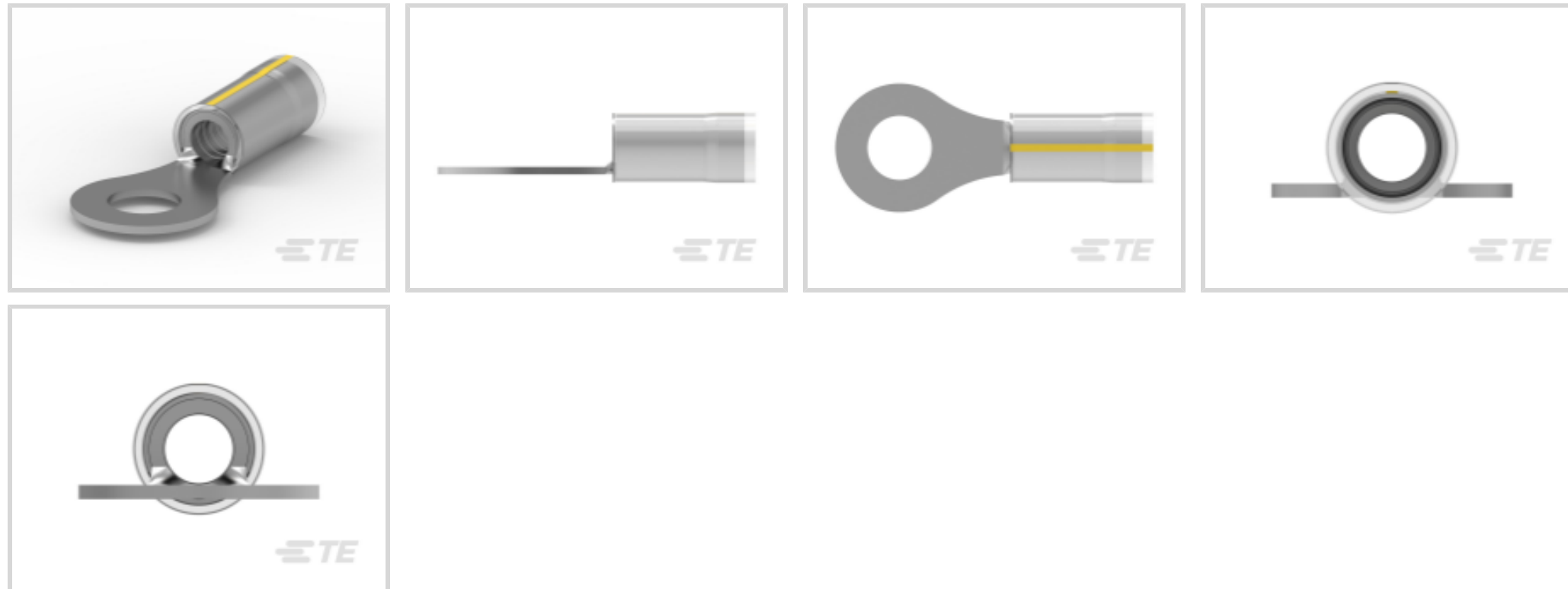

Ring Terminal Product Type: Closed Ring Tongue Terminal

Wire Size: 5180 – 13100 CMA

Stud Size: 1/4, M6

[All PIDG Radiation Resistant C Rings/Spades \(39\)](#)

Features

Product Type Features

Ring Terminal Product Type	Closed Ring Tongue Terminal
Stud Size	1/4, M6
Sealable	No
Wire Insulation Support Retention Type	Insulation Support

Configuration Features

Number of Holes	1
-----------------	---

Body Features

Insulation Sleeve Color	Natural
Stripe Color	Yellow

Contact Features

Military Part Class	Class I
Barrel Type	Closed
Terminal Orientation	Straight
Terminal Plating Material	Tin-Lead



Mechanical Attachment

Wire Insulation Support	With
-------------------------	------

Dimensions

Wire Size	5180 – 13100 CMA
Stud Diameter	6.73 mm [.265 in]
Tongue Thickness	1.04 mm [.041 in]
Product Length	33.58 mm [1.322 in]
Compatible Insulation Diameter (Max)	5.84 mm [.23 in]
Compatible Insulation Diameter Range	3.81 – 5.84 mm [.15 – .23 in]

Usage Conditions

Insulation Option	Partially Insulated
Operating Temperature Range	150 °C [302 °F]

Operation/Application

Compatible With Wire Base Material	Copper
Compatible With Wire Plating Material	Tin

Industry Standards

Government Qualified Terminal	Yes
-------------------------------	-----

Packaging Features

Packaging Quantity	500
Packaging Method	Loose Piece

Other

Terminals & Splices Comment	Brazed Body
-----------------------------	-------------

Product Compliance

[For compliance documentation, visit the product page on TE.com>](#)

EU RoHS Directive 2011/65/EU	Not Compliant
EU ELV Directive 2000/53/EC	Compliant with Exemptions
China RoHS 2 Directive MIIT Order No 32, 2016	Restricted Materials Above Threshold
EU REACH Regulation (EC) No. 1907/2006	Current ECHA Candidate List: JUNE 2023 (235) Candidate List Declared Against: JUNE 2023 (235) SVHC > Threshold:



Pb (13% in Component Part)

Article Safe Usage Statements:

Do not eat, drink or smoke when using this product. Wash thoroughly after handling. Recycle if possible and dispose of the article by following all applicable governmental regulations relevant to your geographic location.

Halogen Content

Not Low Halogen - contains Br or Cl > 900 ppm.

Solder Process Capability

Not applicable for solder process capability

Product Compliance Disclaimer

This information is provided based on reasonable inquiry of our suppliers and represents our current actual knowledge based on the information they provided. This information is subject to change. The part numbers that TE has identified as EU RoHS compliant have a maximum concentration of 0.1% by weight in homogenous materials for lead, hexavalent chromium, mercury, PBB, PBDE, DBP, BBP, DEHP, DIBP, and 0.01% for cadmium, or qualify for an exemption to these limits as defined in the Annexes of Directive 2011/65/EU (RoHS2). Finished electrical and electronic equipment products will be CE marked as required by Directive 2011/65/EU. Components may not be CE marked. Additionally, the part numbers that TE has identified as EU ELV compliant have a maximum concentration of 0.1% by weight in homogenous materials for lead, hexavalent chromium, and mercury, and 0.01% for cadmium, or qualify for an exemption to these limits as defined in the Annexes of Directive 2000/53/EC (ELV). Regarding the REACH Regulation, the information TE provides on SVHC in articles for this part number is based on the latest European Chemicals Agency (ECHA) 'Guidance on requirements for substances in articles' posted at this URL: <https://echa.europa.eu/guidance-documents/guidance-on-reach>

Compatible Parts



TE Part # 59824-1
TETRA-CRIMP PIDG PG FASTON 22-10 ASSY



TE Part # 59239-4
HHHT PIDG PG 12-10 ASSY



TE Part # 58423-1
DIE, RBY IS9252



TE Part # 58433-3
PRO CR ASSY, RBY IS9252



TE Part # 539691-2
ERGO DIE R.B.Y



TE Part # 132246-3
TERMINAL RING TONGUE PIDG 22 18



TE Part # 2063030-1
SDE DIESET, RBY, UL



TE Part # 47808-6
DIES PIDG 12-10 DIE SET

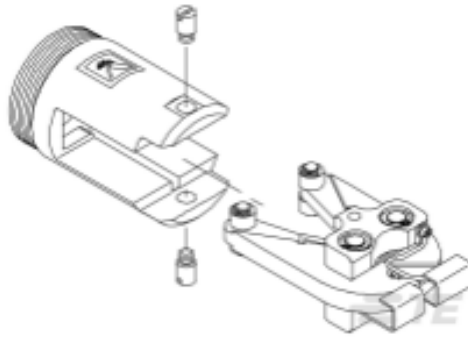

TE Part # 679300-1
1210 PIDG CRIMP HEAD



TE Part # 169400
CERTI-LOK FRAME W/O DIES



TE Part # 1-59239-4
HHHT PIDG 16-10 HEAD



TE Part # 1SET191001R0000
CRIMP-HT



Also in the Series | PIDG

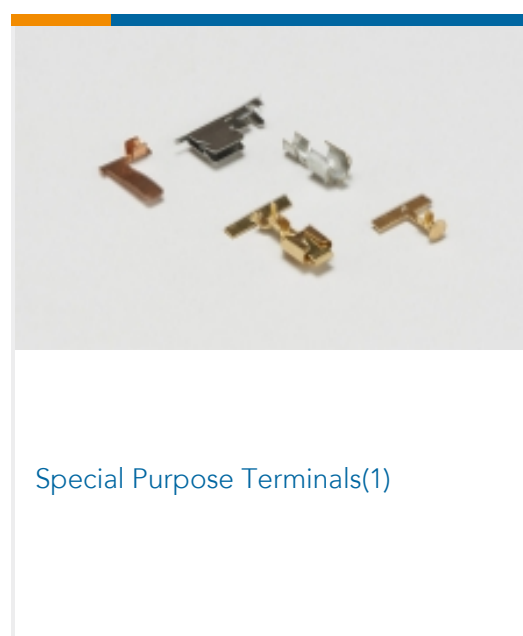
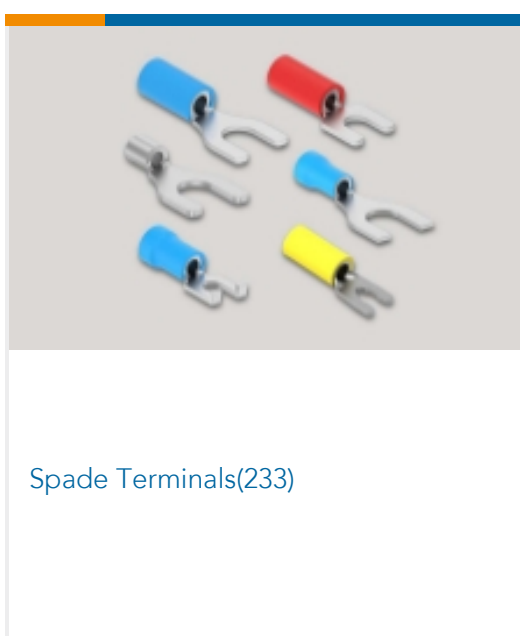
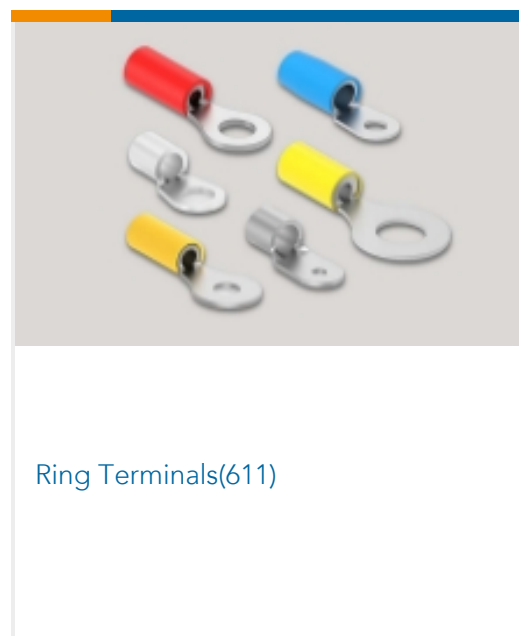
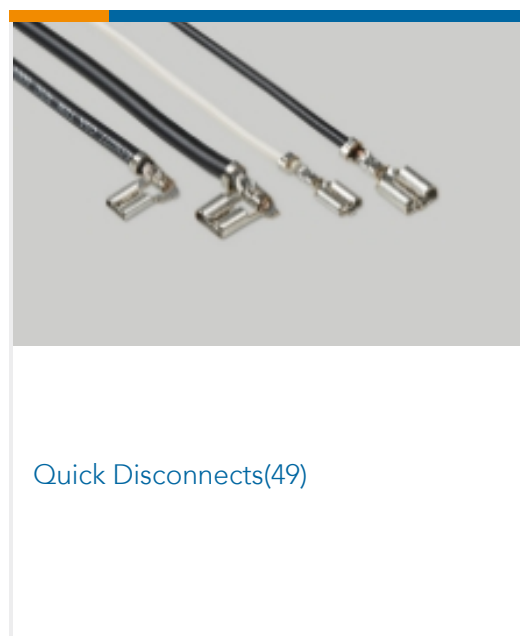
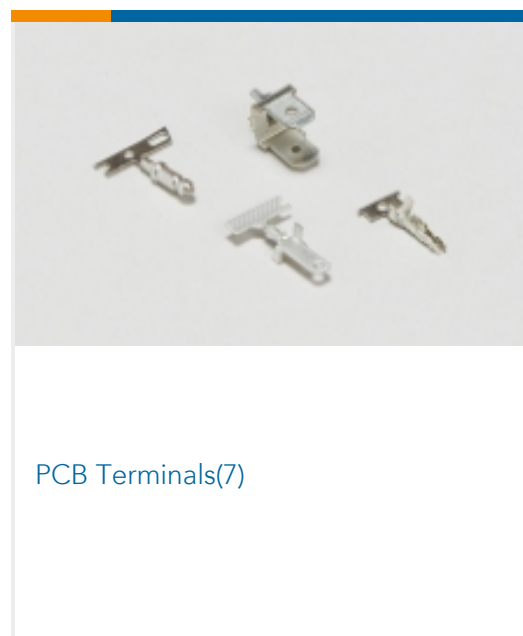
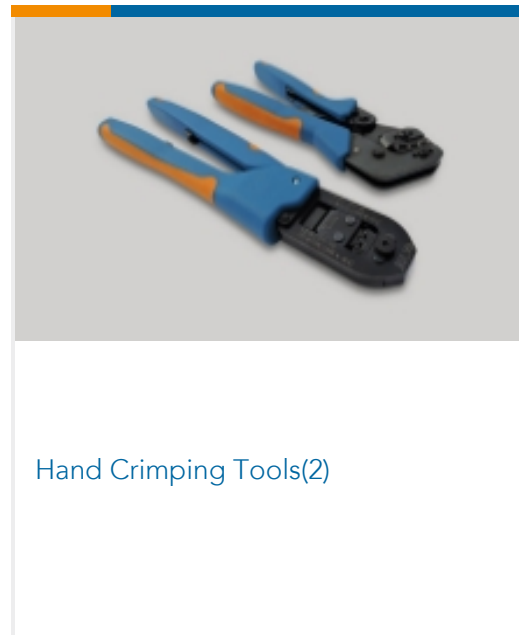
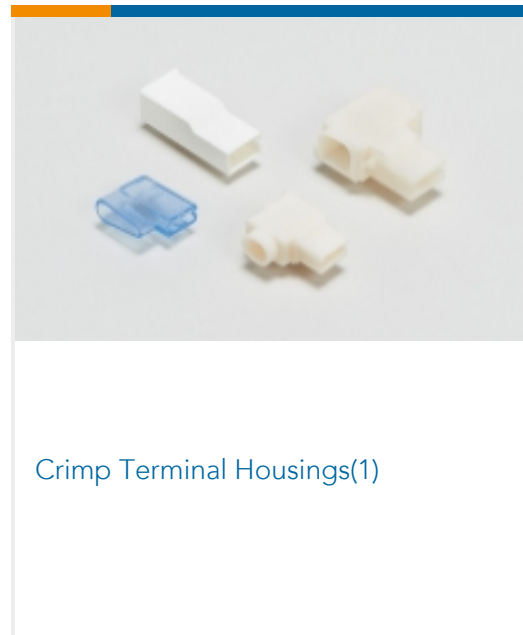
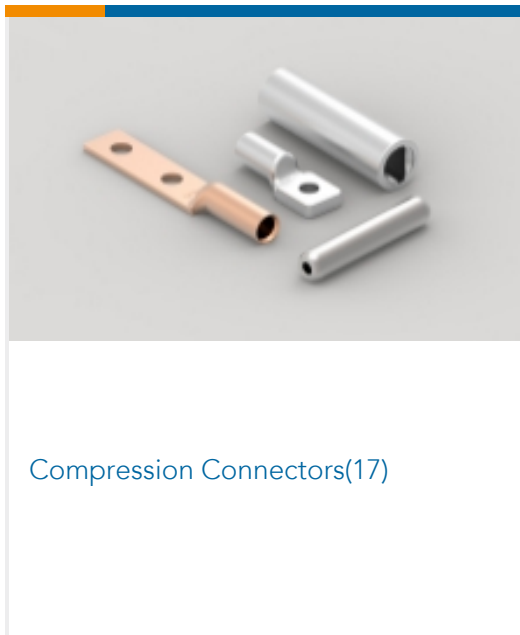

Customers Also Bought





TE Part #53408-1
PIDG PVF2 R 22-16COM22-18MIL 8



TE Part #CX2096-000
D-150-C-12



TE Part #A11769-000
D-150-C-12



TE Part #CX2097-000
D-150-C-13



TE Part #ZPF000000000039519
983-7SE 14-07 SN



TE Part #133104-3
KIT INSERT, REAR, B2TP1, ARINC 404

Documents

Product Drawings

[TERMINAL,PIDG PVF2 R 12-10 1/4](#)

English

CAD Files

Customer View Model

[ENG_CVM_53426-1_L1.3d_igs.zip](#)

English

Customer View Model

[ENG_CVM_53426-1_L1.3d_stp.zip](#)

English

Customer View Model

[ENG_CVM_53426-1_L1.2d_dxf.zip](#)

English

3D PDF

English

By downloading the CAD file I accept and agree to the [Terms and Conditions](#) of use.

Datasheets & Catalog Pages

[RADIATION_RESISTANT_PRE-INSULATED_TERMINALS_SPLICES](#)

English

Product Specifications

[Application Specification](#)

English