

53413-1 ✓ ACTIVE

PIDG

TE Internal #: 53413-1

Closed Ring Tongue Terminal, 22 AWG, M12 / 1/2 Stud Size, 13.08 mm [.515 in] Stud Diameter, Closed Barrel, Straight, Tin-Lead, PIDG

[View on TE.com >](#)



Terminals & Splices > Ring Terminals > PIDG Radiation Resistant C Rings/Spades

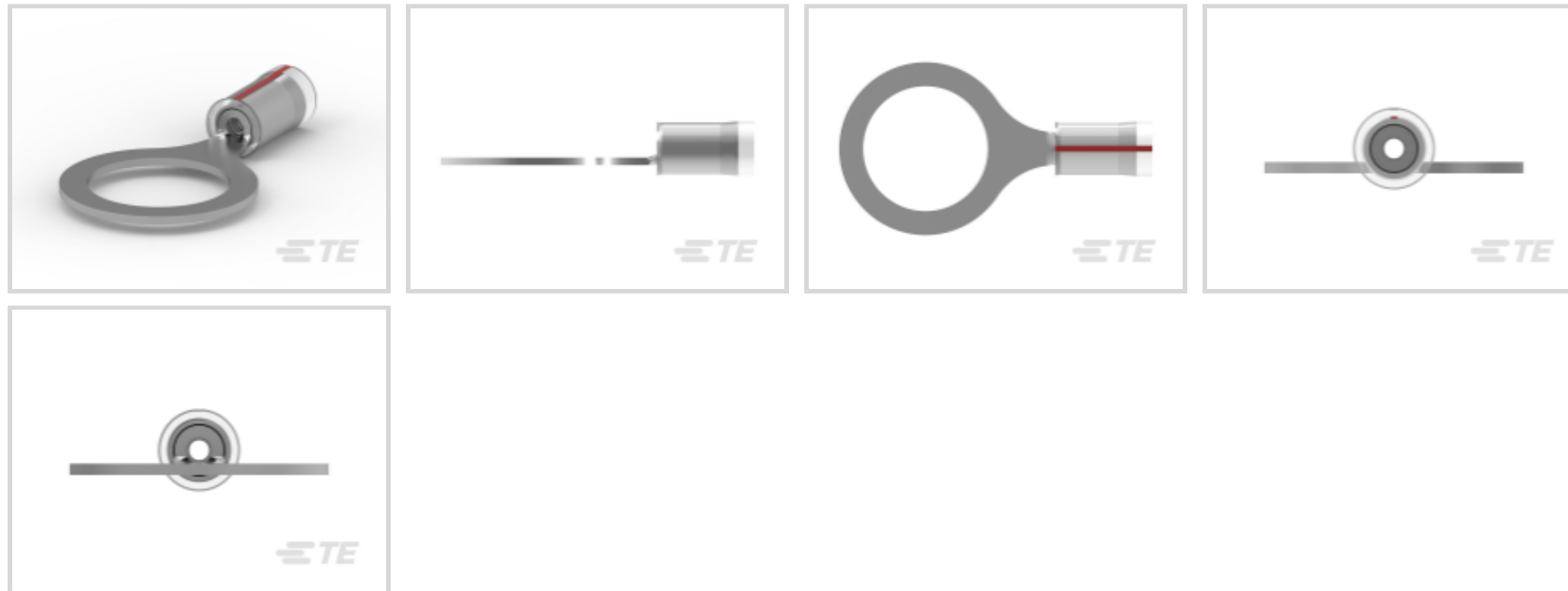

Ring Terminal Product Type: Closed Ring Tongue Terminal

Wire Size: 509 – 3260 CMA

Stud Size: 1/2, M12

[All PIDG Radiation Resistant C Rings/Spades \(39\)](#)

## Features

### Product Type Features

Ring Terminal Product Type	Closed Ring Tongue Terminal
Stud Size	1/2, M12
Sealable	No
Wire Insulation Support Retention Type	Insulation Support

### Configuration Features

Number of Holes	1
-----------------	---

### Body Features

Insulation Sleeve Color	Natural
Stripe Color	Red

### Contact Features

Military Part Class	Class I
Barrel Type	Closed
Terminal Orientation	Straight
Terminal Plating Material	Tin-Lead



### Mechanical Attachment

Wire Insulation Support	With
-------------------------	------

### Dimensions

Wire Size	509 – 3260 CMA
Stud Diameter	13.08 mm[.515 in]
Tongue Thickness	.79 mm[.031 in]
Product Length	32.84 mm[1.293 in]
Compatible Insulation Diameter (Max)	3.18 mm[.125 in]
Compatible Insulation Diameter Range	2.03 – 3.18 mm[.08 – .125 in]

### Usage Conditions

Insulation Option	Partially Insulated
Operating Temperature Range	150 °C[302 °F]

### Operation/Application

Compatible With Wire Base Material	Copper
Compatible With Wire Plating Material	Tin

### Industry Standards

Government Qualified Terminal	Yes
-------------------------------	-----

### Packaging Features

Packaging Quantity	1000
Packaging Method	Loose Piece

### Product Compliance

[For compliance documentation, visit the product page on TE.com>](#)

EU RoHS Directive 2011/65/EU	Not Compliant
EU ELV Directive 2000/53/EC	Compliant with Exemptions
China RoHS 2 Directive MIIT Order No 32, 2016	Restricted Materials Above Threshold
EU REACH Regulation (EC) No. 1907/2006	Current ECHA Candidate List: JUNE 2023 (235) Candidate List Declared Against: JUNE 2023 (235) SVHC > Threshold: Pb (13% in Component Part) <b>Article Safe Usage Statements:</b> Do not eat, drink or smoke when using this product. Wash thoroughly after handling. Recycle if possible and dispose of the article by following all applicable governmental regulations relevant to your geographic location.
Halogen Content	Not Low Halogen - contains Br or Cl > 900

ppm.

Solder Process Capability

Not applicable for solder process capability

Product Compliance Disclaimer

This information is provided based on reasonable inquiry of our suppliers and represents our current actual knowledge based on the information they provided. This information is subject to change. The part numbers that TE has identified as EU RoHS compliant have a maximum concentration of 0.1% by weight in homogenous materials for lead, hexavalent chromium, mercury, PBB, PBDE, DBP, BBP, DEHP, DIBP, and 0.01% for cadmium, or qualify for an exemption to these limits as defined in the Annexes of Directive 2011/65/EU (RoHS2). Finished electrical and electronic equipment products will be CE marked as required by Directive 2011/65/EU. Components may not be CE marked. Additionally, the part numbers that TE has identified as EU ELV compliant have a maximum concentration of 0.1% by weight in homogenous materials for lead, hexavalent chromium, and mercury, and 0.01% for cadmium, or qualify for an exemption to these limits as defined in the Annexes of Directive 2000/53/EC (ELV). Regarding the REACH Regulation, the information TE provides on SVHC in articles for this part number is based on the latest European Chemicals Agency (ECHA) 'Guidance on requirements for substances in articles' posted at this URL: <https://echa.europa.eu/guidance-documents/guidance-on-reach>

### Compatible Parts



TE Part # 59824-1  
TETRA-CRIMP PIDG PG FASTON 22-10 ASSY



REPRESENTATION ONLY

TE Part # 47386  
DAHT PG PIDG 26-16 ASSY



REPRESENTATION ONLY

TE Part # 47386-4  
DAHT PG PIDG 26-16 ASSY



TE Part # 59250  
T-HEAD PIDG 26-14 ASSY



TE Part # 58423-1  
DIE, RBY IS9252



TE Part # 58433-3  
PRO CR ASSY, RBY IS9252



REPRESENTATION ONLY

TE Part # 525690  
DAHT PG PIDG 20-18 ASSY



TE Part # 539691-2  
ERGO DIE R.B.Y



TE Part # 132246-3  
TERMINAL RING TONGUE PIDG 22 18



TE Part # 2063030-1  
SDE DIESET, RBY, UL



TE Part # 47806-2  
DIES PIDG 22-16 DIE SET



TE Part # 59300  
T-HEAD PIDG PG 26-16 ASSY

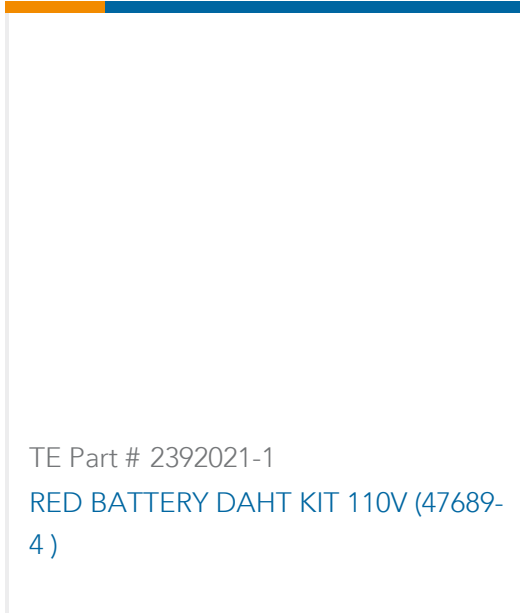
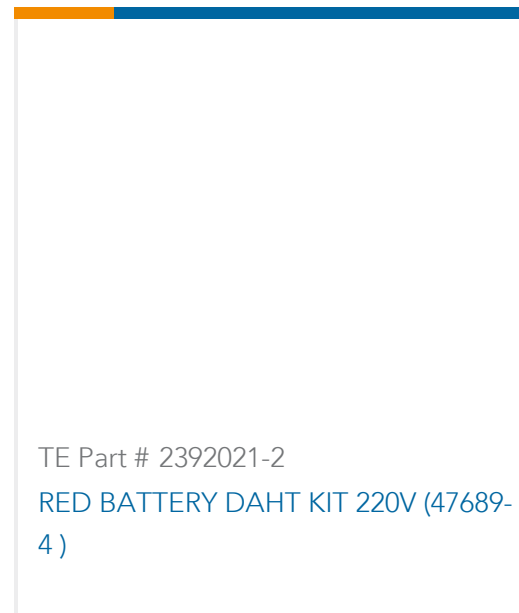

Also in the Series | PIDG

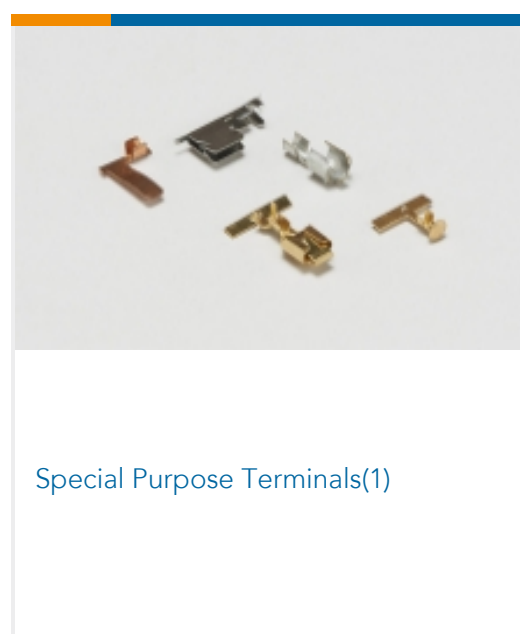
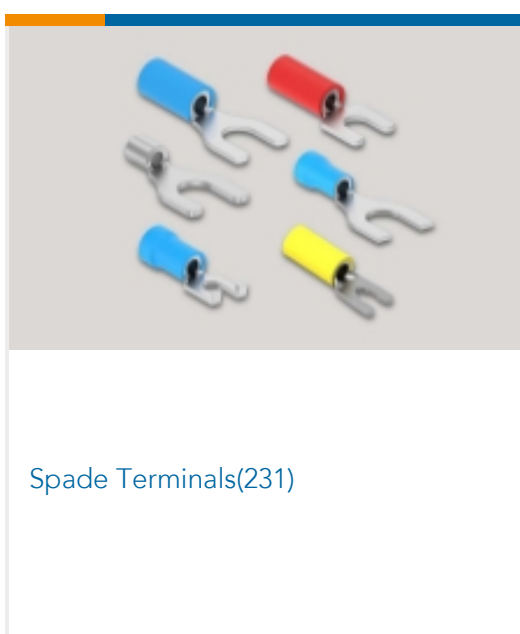
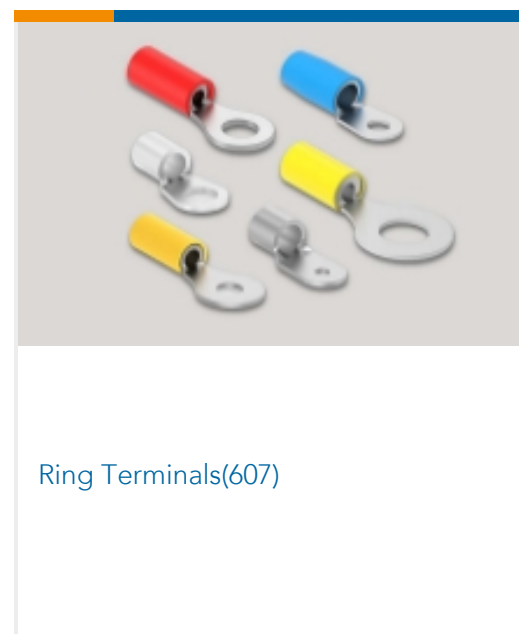
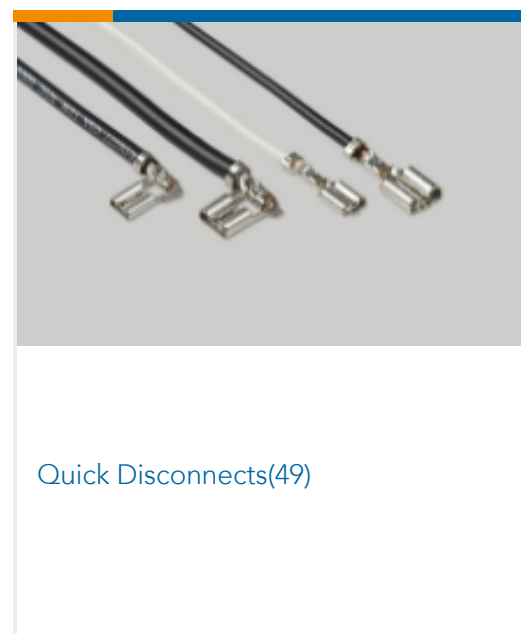
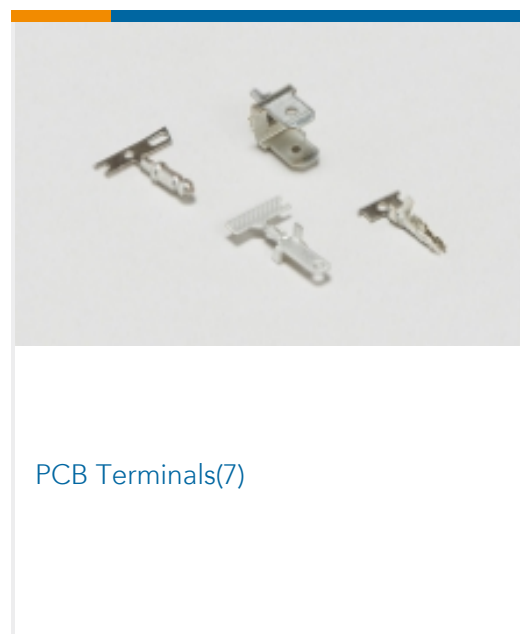
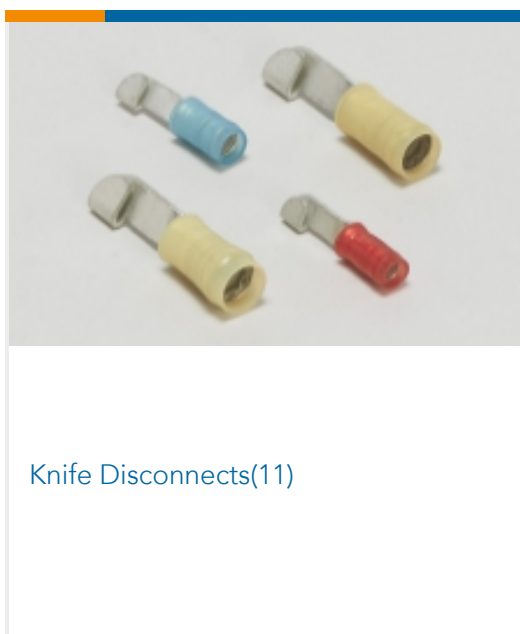
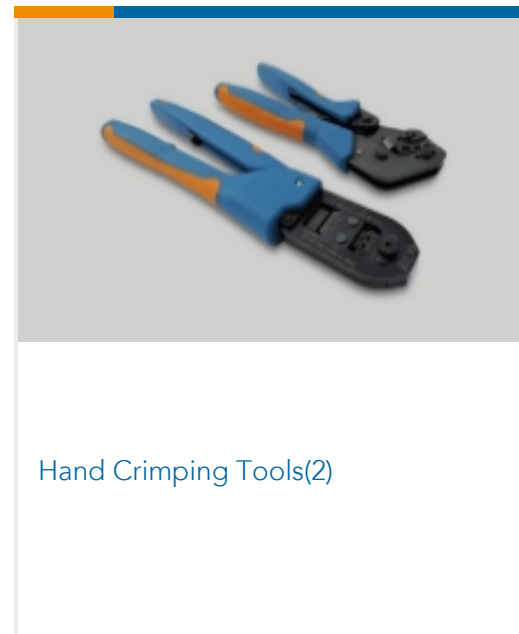
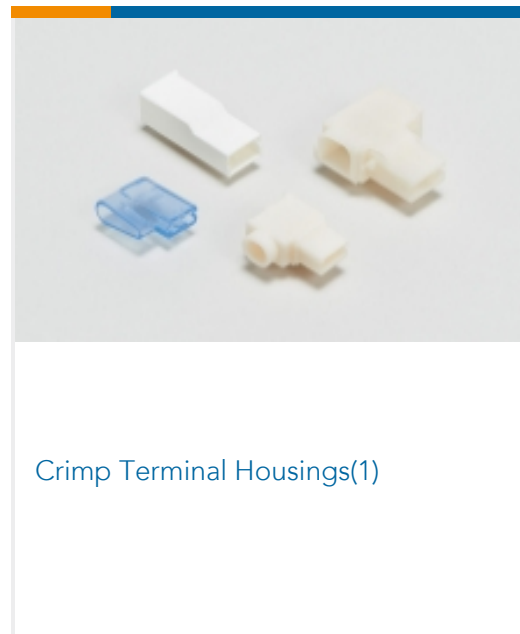

Customers Also Bought



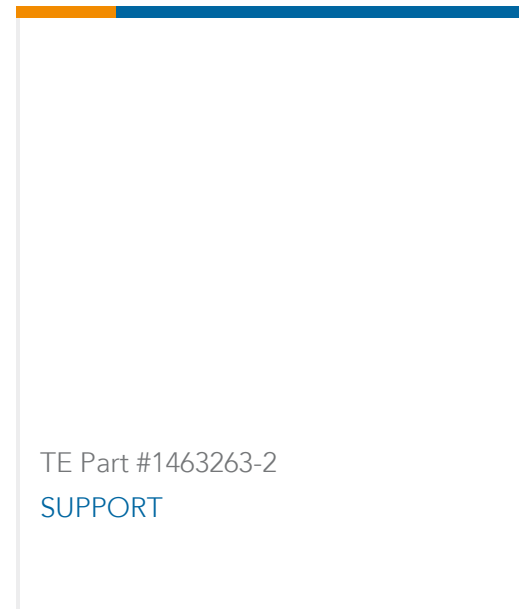
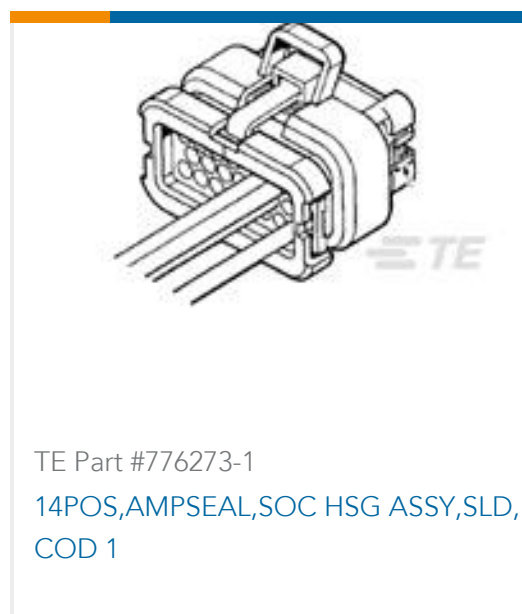

## Documents

### Product Drawings

[PIDG PVF2 22-16COM22-18MIL 1/2](#)

English

### CAD Files

[3D PDF](#)

3D

Customer View Model

[ENG\\_CVM\\_CVM\\_53413-1\\_D.2d\\_dxf.zip](#)

English

Customer View Model

[ENG\\_CVM\\_CVM\\_53413-1\\_D.3d\\_igs.zip](#)

English

Customer View Model

[ENG\\_CVM\\_CVM\\_53413-1\\_D.3d\\_stp.zip](#)

English

By downloading the CAD file I accept and agree to the [Terms and Conditions](#) of use.

### Datasheets & Catalog Pages



## RADIATION\_RESISTANT\_PRE-INSULATED\_TERMINALS\_SPLICES

English

---

### Product Specifications

### Application Specification

English