

53245-2 ✓ ACTIVE

PLASTI-GRIP

TE Internal #: 53245-2

Spring Spade Terminal, 16 AWG, #10 Stud Size, 4.82 mm [.19 in] Stud Diameter, Closed Barrel, Straight, Tin, Partially Insulated, PLASTI-GRIP

[View on TE.com >](#)



Terminals & Splices > Spade Terminals

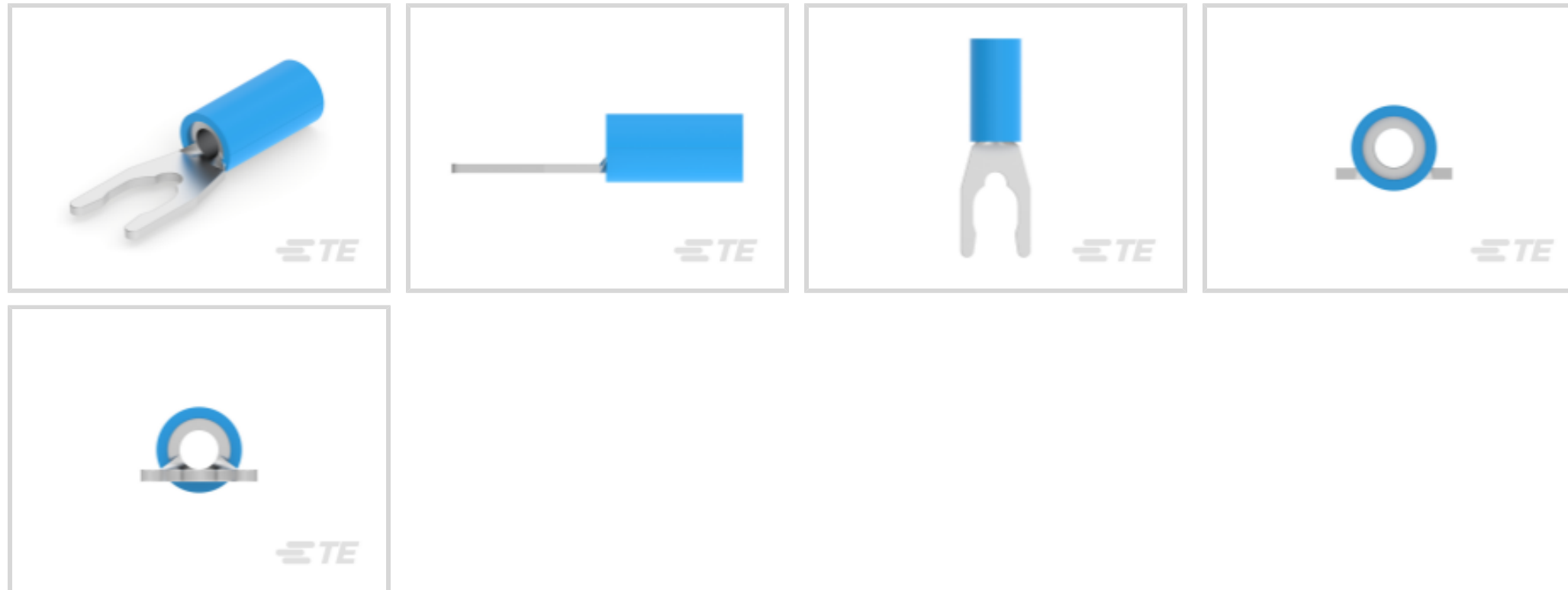

Spade Terminal Type: **Spring Spade Terminal**

Wire Size: **2050 – 5180 CMA**

Stud Size: **#10**

**Features**

**Product Type Features**

Stud Size	#10
Sealable	No
Wire Insulation Support Retention Type	Insulation Support

**Electrical Characteristics**

Voltage Rating	600 V
----------------	-------

**Body Features**

Insulation Sleeve Color	Blue
Stripe Color	Blue

**Contact Features**

Spade Terminal Type	Spring Spade Terminal
Barrel Type	Closed
Terminal Orientation	Straight
Terminal Plating Material	Tin

**Mechanical Attachment**

Wire Insulation Support	With
-------------------------	------



### Dimensions

Wire Size	2050 – 5180 CMA
Stud Diameter	4.82 mm [.19 in]
Tongue Thickness	.79 mm [.031 in]
Product Length	23.37 mm [.92 in]
Compatible Insulation Diameter (Max)	4.9 mm [.193 in]
Compatible Insulation Diameter Range	3 – 4.9 mm [.118 – .193 in]

### Usage Conditions

Insulation Option	Partially Insulated
Operating Temperature Range	105 °C [221 °F]

### Operation/Application

Compatible With Wire Base Material	Copper
Compatible With Wire Plating Material	Tin

### Industry Standards

Government Qualified Terminal	No
-------------------------------	----

### Packaging Features

Packaging Quantity	5000
Packaging Method	Tape Mounted

### Product Compliance

[For compliance documentation, visit the product page on TE.com>](#)

EU RoHS Directive 2011/65/EU	Compliant
EU ELV Directive 2000/53/EC	Compliant
China RoHS 2 Directive MIIT Order No 32, 2016	No Restricted Materials Above Threshold
EU REACH Regulation (EC) No. 1907/2006	Current ECHA Candidate List: JUNE 2023 (235) Candidate List Declared Against: JUNE 2023 (235) Does not contain REACH SVHC
Halogen Content	Not Low Halogen - contains Br or Cl > 900 ppm.
Solder Process Capability	Not applicable for solder process capability

Product Compliance Disclaimer

This information is provided based on reasonable inquiry of our suppliers and represents our current actual knowledge based on the information they provided. This information is subject to change. The part numbers that TE has identified as EU RoHS compliant have a maximum concentration of 0.1% by weight in homogenous materials for lead, hexavalent chromium, mercury, PBB, PBDE, DBP, BBP, DEHP, DIBP, and 0.01% for cadmium, or qualify for an exemption to these limits as defined in the Annexes of Directive 2011/65/EU (RoHS2). Finished electrical and electronic equipment products will be CE marked as required by Directive 2011/65/EU. Components may not be CE marked. Additionally, the part numbers that TE has identified as EU ELV compliant have a maximum concentration of 0.1% by weight in homogenous materials for lead, hexavalent chromium, and mercury, and 0.01% for cadmium, or qualify for an exemption to these limits as defined in the Annexes of Directive 2000/53/EC (ELV). Regarding the REACH Regulation, the information TE provides on SVHC in articles for this part number is based on the latest European Chemicals Agency (ECHA) 'Guidance on requirements for substances in articles' posted at this URL: <https://echa.europa.eu/guidance-documents/guidance-on-reach>

## Compatible Parts

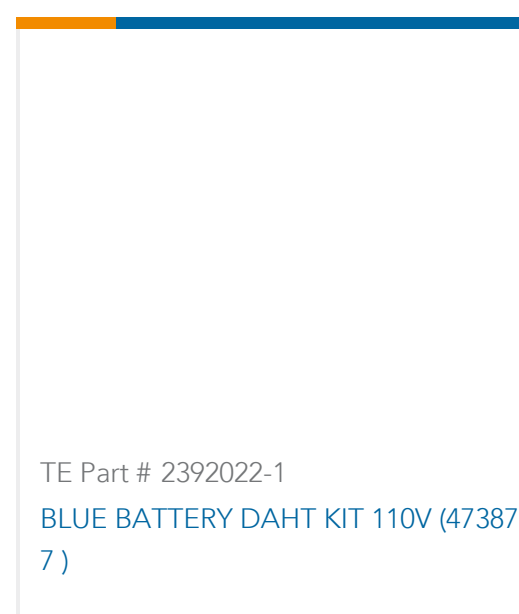
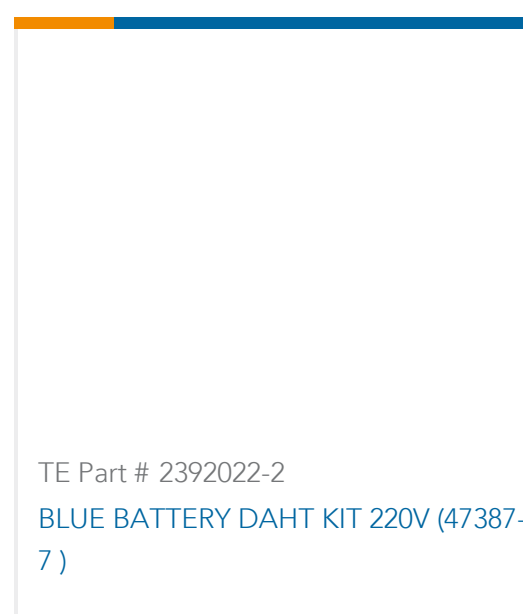

## Also in the Series | PLASTI-GRIP



Compression Connectors(3)



Crimp Wire Pins, Tabs & Ferrules(25)

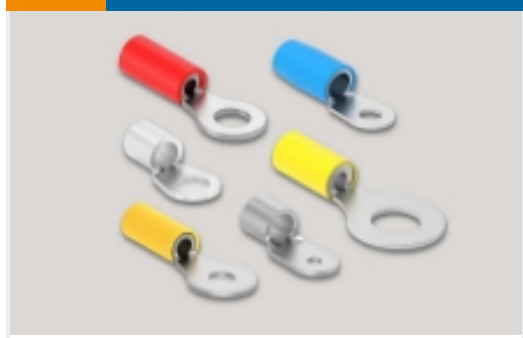

Ring Terminals(333)

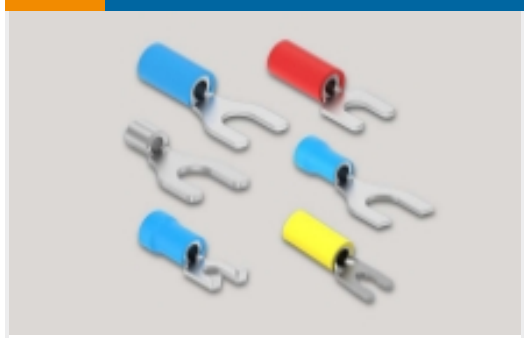

Spade Terminals(195)



Splices(50)

## Customers Also Bought

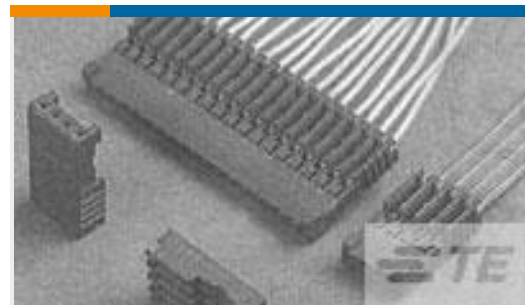

TE Part #281784-4  
PLUG HE13 IDC 180 4 P AWG 26-24



TE Part #1971783-1  
PTL RECEPTACLE CONTACT, 16-19 AWG, 2X22

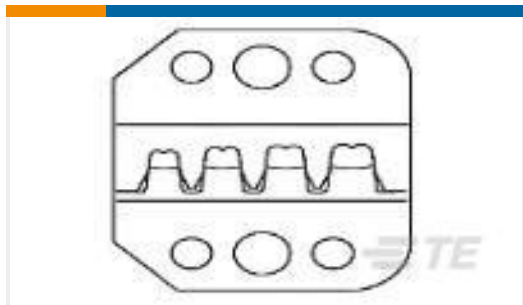

TE Part #58628-2  
PROCRMP DIESET 26-14 ULTRAFast



TE Part #2-34120-1  
TERMINAL, SOLIS R 16-14 6

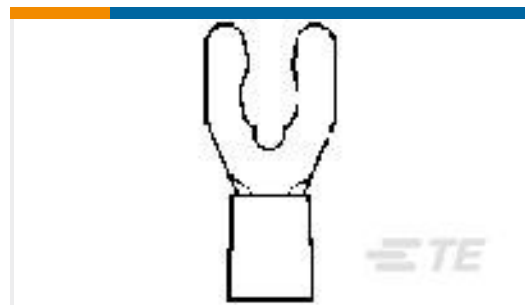

TE Part #52951-3  
PG SPR SPD 22-16COM22-18MIL 10



TE Part #40523  
RING TERMINAL 12-10 AWG TPBR



TE Part #3-1971776-3  
PTL 2X3 PLUG HSG STD TEMP KEY C BLU



TE Part #3-640429-6  
06P MTA156 CONN ASSY 24AWG WHT



TE Part #2329908-1  
Power Versa-Lock SEAL TAB, 18-20 AWG



## Documents

### Product Drawings

[TERMINAL,PG SPR SPD 16-14 10](#)

English

---

### CAD Files

[3D PDF](#)

3D

Customer View Model

[ENG\\_CVM\\_CVM\\_53245-2\\_L.2d\\_dxf.zip](#)

English

Customer View Model

[ENG\\_CVM\\_CVM\\_53245-2\\_L.3d\\_igs.zip](#)

English

Customer View Model

[ENG\\_CVM\\_CVM\\_53245-2\\_L.3d\\_stp.zip](#)

English

Customer View Model

[ENG\\_CVM\\_53245-2\\_L1.3d\\_igs.zip](#)

English

Customer View Model

[ENG\\_CVM\\_53245-2\\_L1.3d\\_stp.zip](#)

English

Customer View Model

[ENG\\_CVM\\_53245-2\\_L1.2d\\_dxf.zip](#)

English

[3D PDF](#)

English

By downloading the CAD file I accept and agree to the [Terms and Conditions](#) of use.

---

### Product Specifications

[Application Specification](#)

English

---

### Product Environmental Compliance

[Product Compliance](#)

English

[Product Compliance](#)

English

---

### Agency Approvals

[UL Report](#)

English