

52955 ✓ ACTIVE

PLASTI-GRIP

TE Internal #: 52955

Spring Spade Terminal, 16 – 14 AWG, #6 / M3.5 Stud Size, 3.56 mm [.14 in] Stud Diameter, Closed Barrel, Straight, Tin, PLASTI-GRIP

[View on TE.com >](#)



Terminals & Splices > Spade Terminals

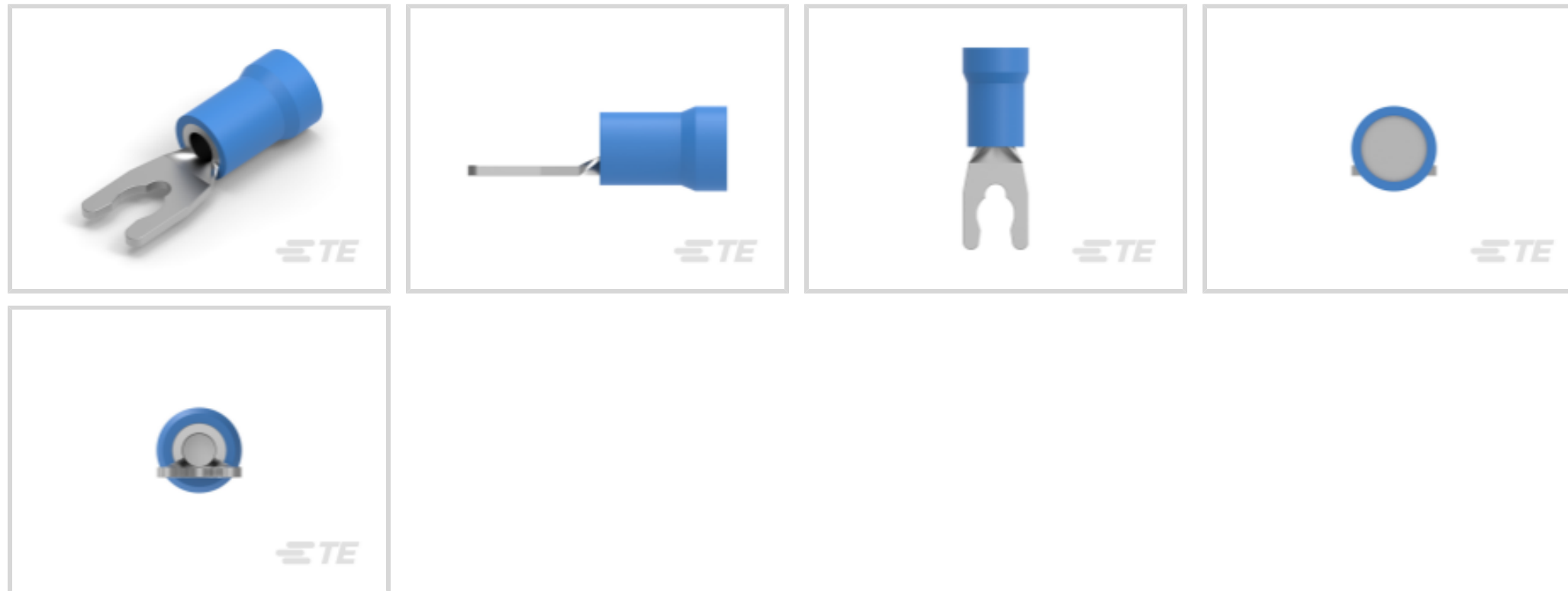

Spade Terminal Type: **Spring Spade Terminal**

Wire Size: **2050 – 5180 CMA**

Stud Size: **#6, M3.5**

Features

Product Type Features

Stud Size	#6, M3.5
Sealable	No
Wire Insulation Support Retention Type	Insulation Support

Electrical Characteristics

Voltage Rating	600 V
----------------	-------

Body Features

Insulation Sleeve Color	Blue
Stripe Color	Red

Contact Features

Spade Terminal Type	Spring Spade Terminal
Barrel Type	Closed
Terminal Orientation	Straight
Terminal Plating Material	Tin

Mechanical Attachment

Wire Insulation Support	With
-------------------------	------



Dimensions

Wire Size	2050 – 5180 CMA
Stud Diameter	3.56 mm [.14 in]
Tongue Thickness	.79 mm [.031 in]
Product Length	20.6 mm [.811 in]
Compatible Insulation Diameter (Max)	4.9 mm [.193 in]
Compatible Insulation Diameter Range	3 – 4.9 mm [.118 – .193 in]

Usage Conditions

Insulation Option	Partially Insulated
Operating Temperature Range	105 °C [221 °F]

Operation/Application

Compatible With Wire Base Material	Copper
Compatible With Wire Plating Material	Tin

Industry Standards

Government Qualified Terminal	No
-------------------------------	----

Packaging Features

Packaging Quantity	1000
Packaging Method	Loose Piece

Product Compliance

[For compliance documentation, visit the product page on TE.com>](#)

EU RoHS Directive 2011/65/EU	Compliant
EU ELV Directive 2000/53/EC	Compliant
China RoHS 2 Directive MIIT Order No 32, 2016	No Restricted Materials Above Threshold
EU REACH Regulation (EC) No. 1907/2006	Current ECHA Candidate List: JUNE 2023 (235) Candidate List Declared Against: JUNE 2023 (235) Does not contain REACH SVHC
Halogen Content	Not Low Halogen - contains Br or Cl > 900 ppm.
Solder Process Capability	Not applicable for solder process capability

Product Compliance Disclaimer

This information is provided based on reasonable inquiry of our suppliers and represents our current actual knowledge based on the information they provided. This information is subject to change. The part numbers that TE has identified as EU RoHS compliant have a maximum concentration of 0.1% by weight in homogenous materials for lead, hexavalent chromium, mercury, PBB, PBDE, DBP, BBP, DEHP, DIBP, and 0.01% for cadmium, or qualify for an exemption to these limits as defined in the Annexes of Directive 2011/65/EU (RoHS2). Finished electrical and electronic equipment products will be CE marked as required by Directive 2011/65/EU. Components may not be CE marked. Additionally, the part numbers that TE has identified as EU ELV compliant have a maximum concentration of 0.1% by weight in homogenous materials for lead, hexavalent chromium, and mercury, and 0.01% for cadmium, or qualify for an exemption to these limits as defined in the Annexes of Directive 2000/53/EC (ELV). Regarding the REACH Regulation, the information TE provides on SVHC in articles for this part number is based on the latest European Chemicals Agency (ECHA) 'Guidance on requirements for substances in articles' posted at this URL: <https://echa.europa.eu/guidance-documents/guidance-on-reach>

Compatible Parts

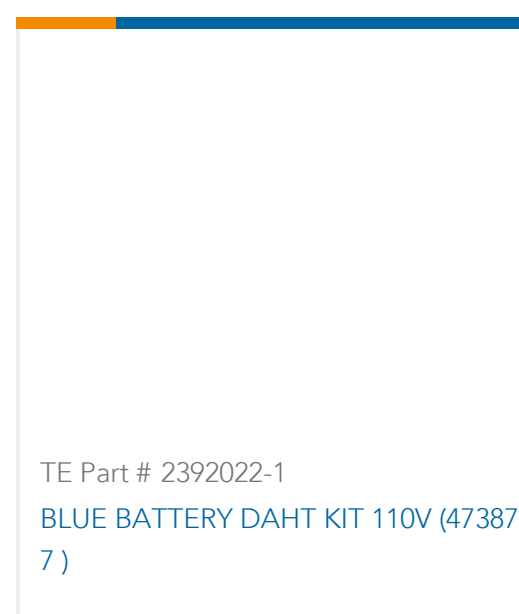
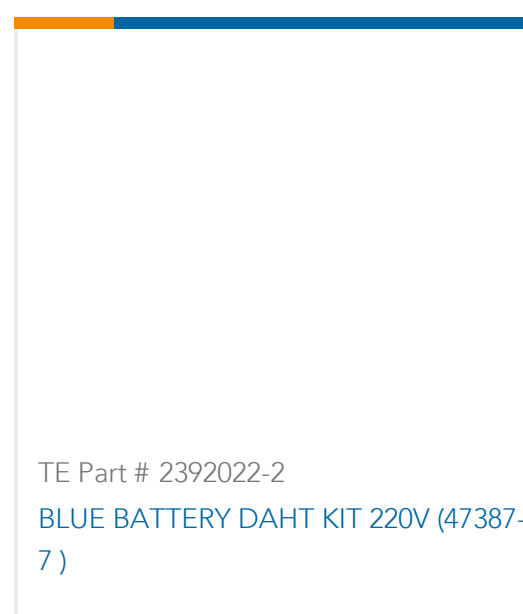

Also in the Series | PLASTI-GRIP



Compression Connectors(3)



Crimp Wire Pins, Tabs & Ferrules(25)



Ring Terminals(333)

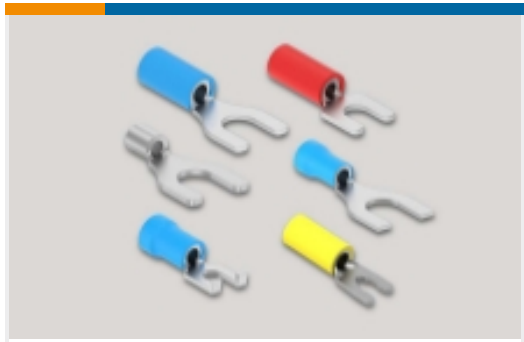

Spade Terminals(195)



Splices(50)

Customers Also Bought



TE Part #52937
TERMINAL,PIDG SPR SPD 16-14 10



TE Part #6609047-3
15VT1=F7334 S0



TE Part #59824-1
TETRA-CRIMP PIDG PG FASTON 22-10 ASSY



TE Part #321165
TERMINAL,SOLIS R 16-14HD 1/2

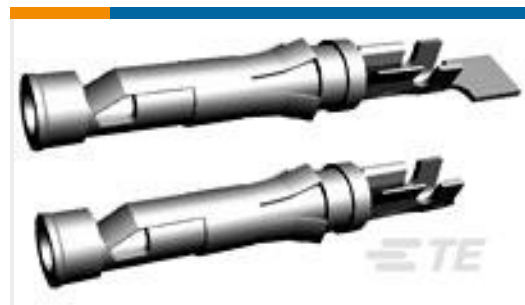

TE Part #66601-1
III+ SKT,18-14,TIN-LEAD,LP



TE Part #1-350777-9
02P UMNL V0 PLUG HSG BLACK

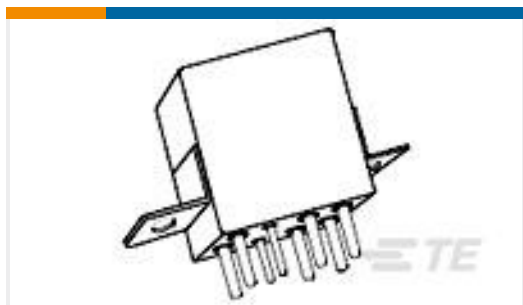

TE Part #9-1617748-2
FCA-210-0919M=M83536/9-019M

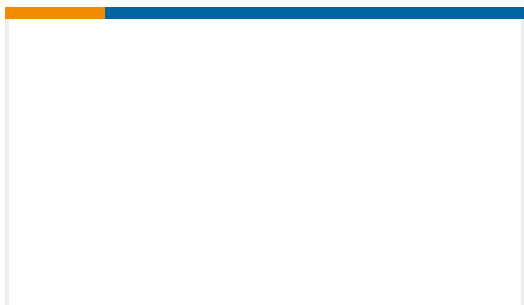

TE Part #662903-2
ANVIL, TETRA-CRIMP



TE Part #20010725-09
PRESS XDCR U535D-000005-150PG



Documents

Product Drawings

[TERMINAL,PG SPR SPD 16-14 6](#)

English

CAD Files

3D PDF

3D

Customer View Model

[ENG_CVM_CVM_52955_U.2d_dxf.zip](#)

English

Customer View Model

[ENG_CVM_CVM_52955_U.3d_igs.zip](#)

English

Customer View Model

[ENG_CVM_CVM_52955_U.3d_stp.zip](#)

English

3D PDF

English

Customer View Model

[ENG_CVM_52955_N1.3d_igs.zip](#)

English

Customer View Model

[ENG_CVM_52955_N1.3d_stp.zip](#)

English

Customer View Model

[ENG_CVM_52955_N1.2d_dxf.zip](#)

English

By downloading the CAD file I accept and agree to the [Terms and Conditions](#) of use.

Product Specifications

[Application Specification](#)

English

Product Environmental Compliance

[MD_52955_03012011527](#)

English

[MD_52955_03012011527](#)

English

[TE Material Declaration](#)

English

Instruction Sheets

[AMP* PIDG* \(VINYL\) & PLASTI-GRIP* SHORT SPRING SPADE TERMINALS FOR BAR](#)

English



[Instruction Sheet \(U.S.\)](#)

English

[Agency Approvals](#)

[UL Report](#)

English

[UL Report](#)

English