

52421-1 ✓ ACTIVE



## PIDG

TE Internal #: 52421-1

Spring Spade Terminal, 16 – 14 AWG, #8 / M4 Stud Size, 4.17 mm [.164 in] Stud Diameter, Closed Barrel, Straight, Tin, Partially Insulated, PIDG

[View on TE.com >](#)

Terminals & Splices > Spade Terminals > PIDG Long Spring Spade Tongue Terminals

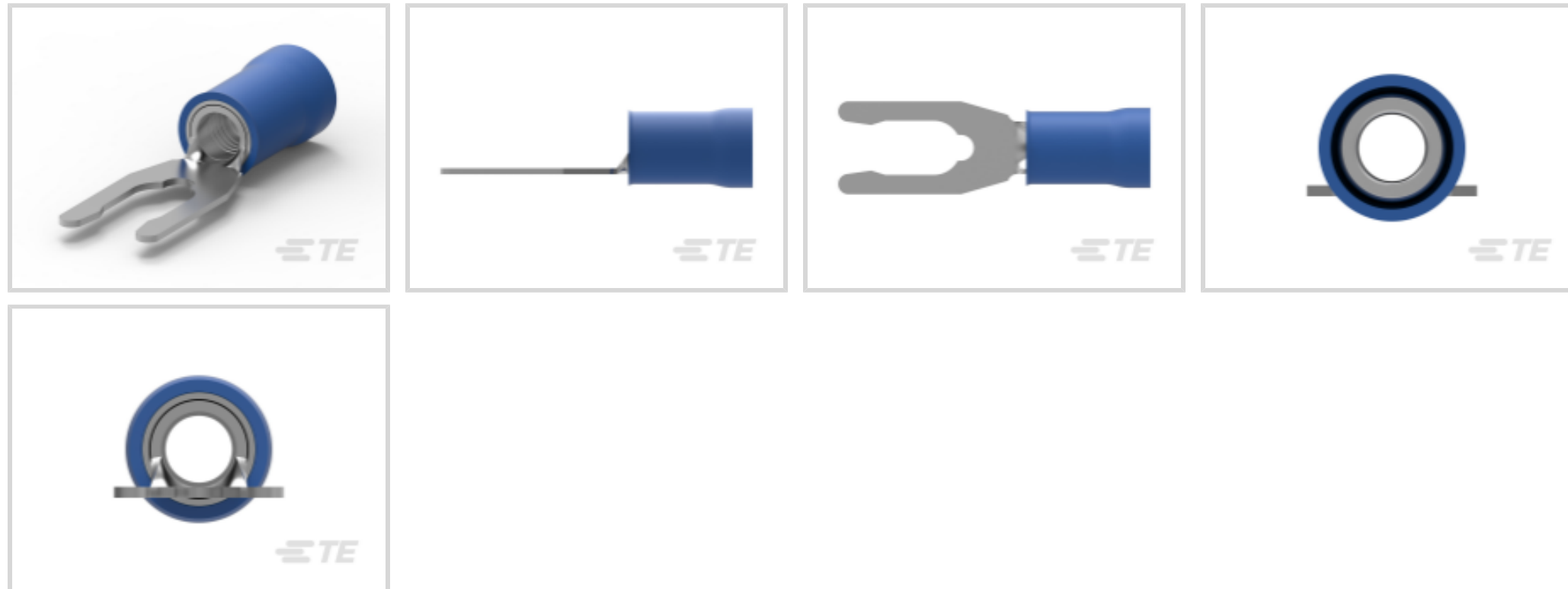

Spade Terminal Type: **Spring Spade Terminal**

Wire Size: **2050 – 5180 CMA**

Stud Size: **#8, M4**

[All PIDG Long Spring Spade Tongue Terminals \(50\)](#)

## Features

### Product Type Features

Stud Size	#8, M4
Sealable	No
Wire Insulation Support Retention Type	Insulation Support

### Electrical Characteristics

Voltage Rating	300 V
----------------	-------

### Body Features

Insulation Sleeve Color	Blue
Stripe Color	Blue

### Contact Features

Spade Terminal Type	Spring Spade Terminal
Barrel Type	Closed
Terminal Orientation	Straight
Terminal Plating Material	Tin

### Mechanical Attachment



Wire Insulation Support	With
-------------------------	------

### Dimensions

Wire Size	2050 – 5180 CMA
Stud Diameter	4.17 mm [.164 in]
Tongue Thickness	.79 mm [.031 in]
Product Length	24.9 mm [.979 in]
Compatible Insulation Diameter (Max)	4.32 mm [.17 in]
Compatible Insulation Diameter Range	2.92 – 4.31 mm [.115 – .17 in]

### Usage Conditions

Insulation Option	Partially Insulated
Operating Temperature Range	105 °C [221 °F]

### Operation/Application

Compatible With Wire Base Material	Copper
Compatible With Wire Plating Material	Tin

### Industry Standards

Government Qualified Terminal	No
-------------------------------	----

### Packaging Features

Packaging Quantity	1000
Packaging Method	Loose Piece

### Product Compliance

[For compliance documentation, visit the product page on TE.com>](#)

EU RoHS Directive 2011/65/EU	Compliant
EU ELV Directive 2000/53/EC	Compliant
China RoHS 2 Directive MIIT Order No 32, 2016	No Restricted Materials Above Threshold
EU REACH Regulation (EC) No. 1907/2006	Current ECHA Candidate List: JUNE 2023 (235) Candidate List Declared Against: JUNE 2023 (235) Does not contain REACH SVHC
Halogen Content	Low Halogen - Br, Cl, F, I < 900 ppm per homogenous material. Also BFR/CFR/PVC Free
Solder Process Capability	Not applicable for solder process capability

### Product Compliance Disclaimer

This information is provided based on reasonable inquiry of our suppliers and represents our current actual knowledge based on the information they provided. This information is subject to change. The part numbers that TE has identified as EU RoHS compliant have a maximum concentration of 0.1% by weight in homogenous materials for lead, hexavalent chromium, mercury, PBB, PBDE, DBP, BBP, DEHP, DIBP, and 0.01% for cadmium, or qualify for an exemption to these limits as defined in the Annexes of Directive 2011/65/EU (RoHS2). Finished electrical and electronic equipment products will be CE marked as required by Directive 2011/65/EU. Components may not be CE marked. Additionally, the part numbers that TE has identified as EU ELV compliant have a maximum concentration of 0.1% by weight in homogenous materials for lead, hexavalent chromium, and mercury, and 0.01% for cadmium, or qualify for an exemption to these limits as defined in the Annexes of Directive 2000/53/EC (ELV). Regarding the REACH Regulation, the information TE provides on SVHC in articles for this part number is based on the latest European Chemicals Agency (ECHA) 'Guidance on requirements for substances in articles' posted at this URL: <https://echa.europa.eu/guidance-documents/guidance-on-reach>

## Compatible Parts



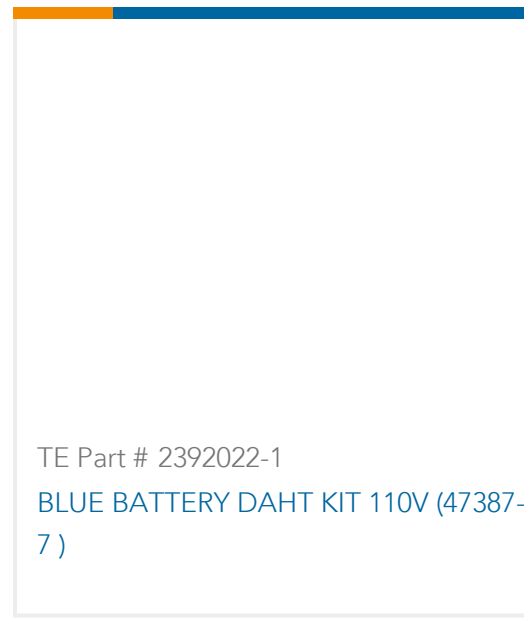
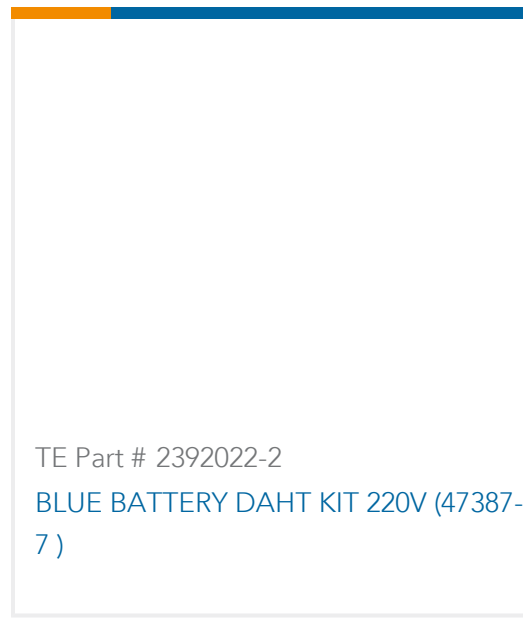

## Also in the Series | PIDG

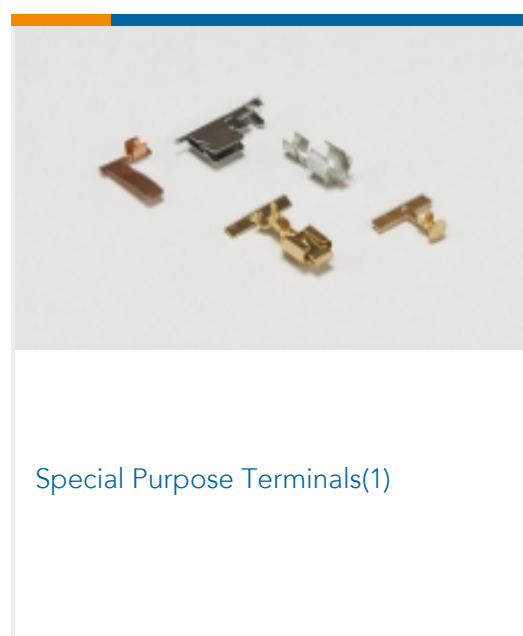
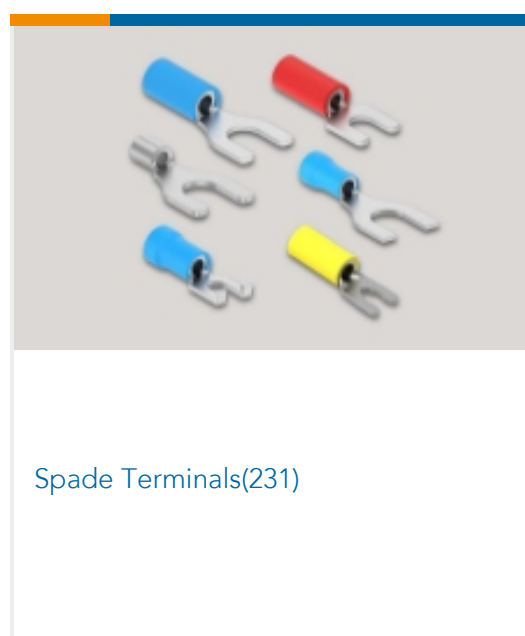
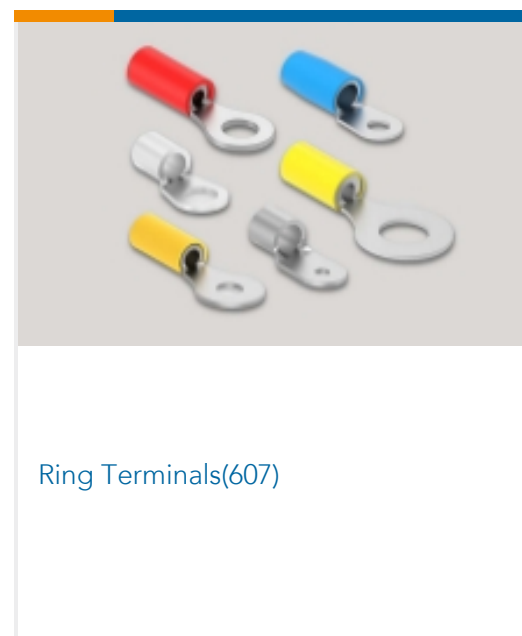
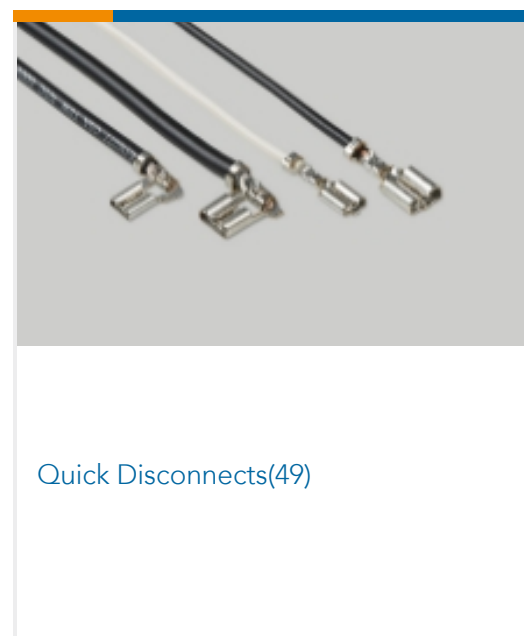
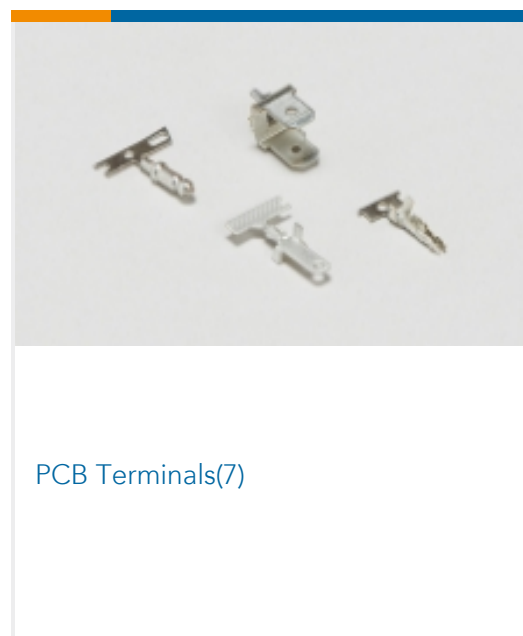
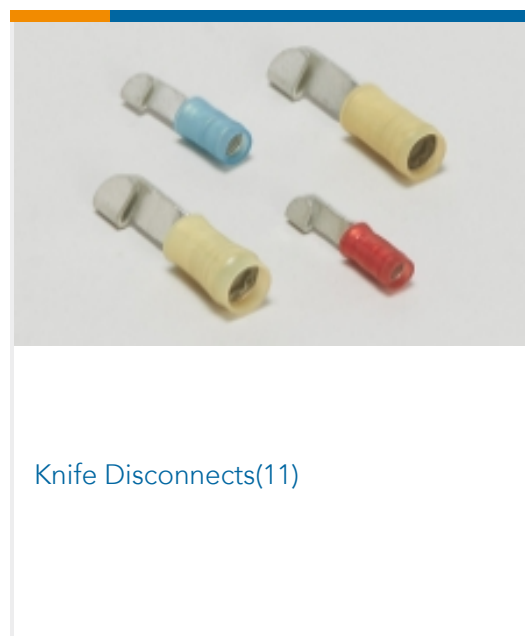
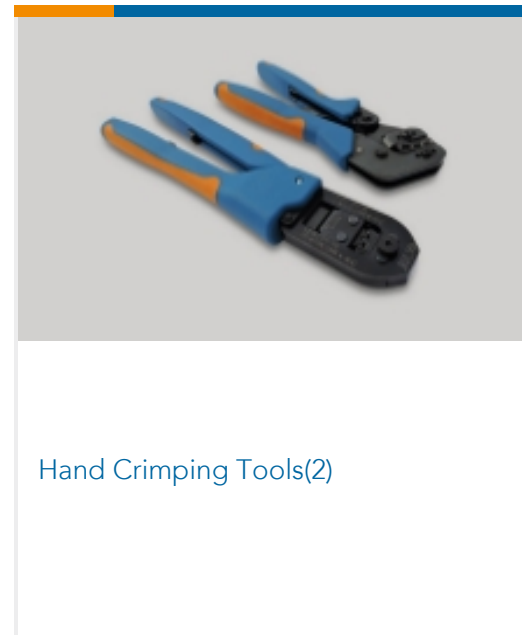
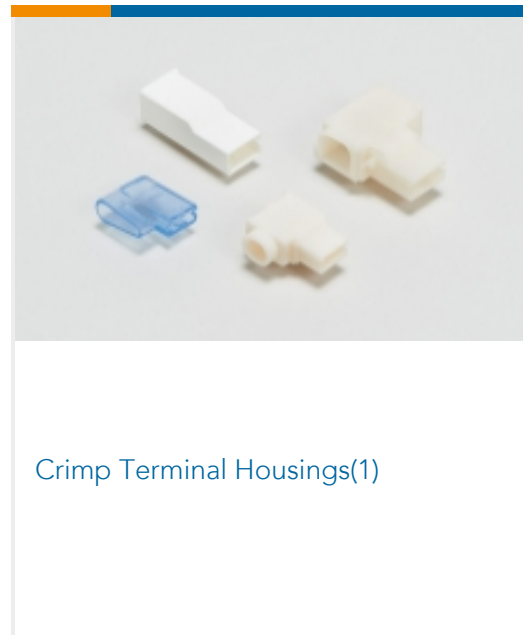
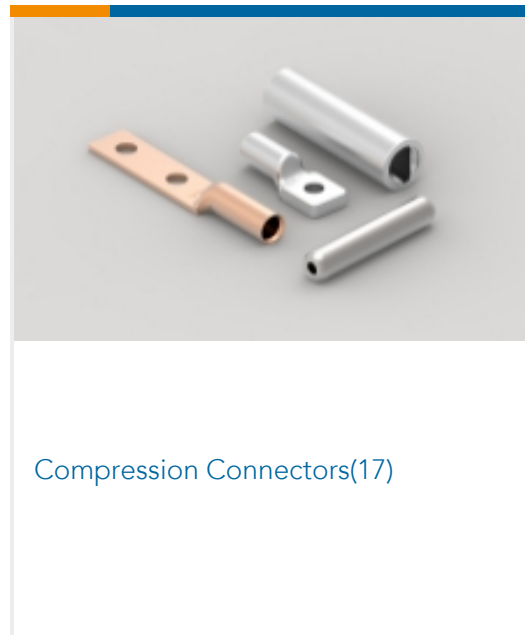

## Customers Also Bought



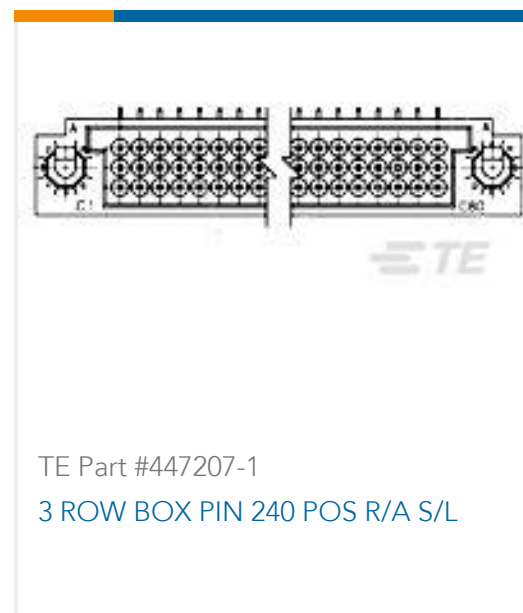

## Documents

### Product Drawings

[TERMINAL,PIDG SPR SPD 16-14 8](#)

English

### CAD Files

Customer View Model

[ENG\\_CVM\\_52421-1\\_H.3d\\_igs.zip](#)

English

Customer View Model

[ENG\\_CVM\\_52421-1\\_H.3d\\_stp.zip](#)

English

Customer View Model

[ENG\\_CVM\\_52421-1\\_H.2d\\_dxf.zip](#)

English

**3D PDF**

English

**3D PDF**

3D

Customer View Model

[ENG\\_CVM\\_CVM\\_52421-1\\_J.2d\\_dxf.zip](#)

English

Customer View Model

[ENG\\_CVM\\_CVM\\_52421-1\\_J.3d\\_igs.zip](#)

English

Customer View Model

[ENG\\_CVM\\_CVM\\_52421-1\\_J.3d\\_stp.zip](#)

English



By downloading the CAD file I accept and agree to the [Terms and Conditions](#) of use.

---

### Datasheets & Catalog Pages

[PIDG TERMINALS & SPLICES Quick Reference Guide](#)

English

---

### Product Specifications

[Application Specification](#)

English

---

### Product Environmental Compliance

[MD\\_52421-1\\_07292015926\\_dmtec](#)

English

[MD\\_52421-1\\_07292015926\\_dmtec](#)

English

---

### Agency Approvals

[UL Report](#)

English