

52409 ✓ ACTIVE



PIDG

TE Internal #: 52409

Spring Spade Terminal, 22 – 16 AWG, M3.5 / #6 Stud Size, 3.51 mm [.138 in] Stud Diameter, Closed Barrel, Straight, Tin, Partially Insulated, PIDG

[View on TE.com >](#)

Terminals & Splices > Spade Terminals > PIDG Long Spring Spade Tongue Terminals

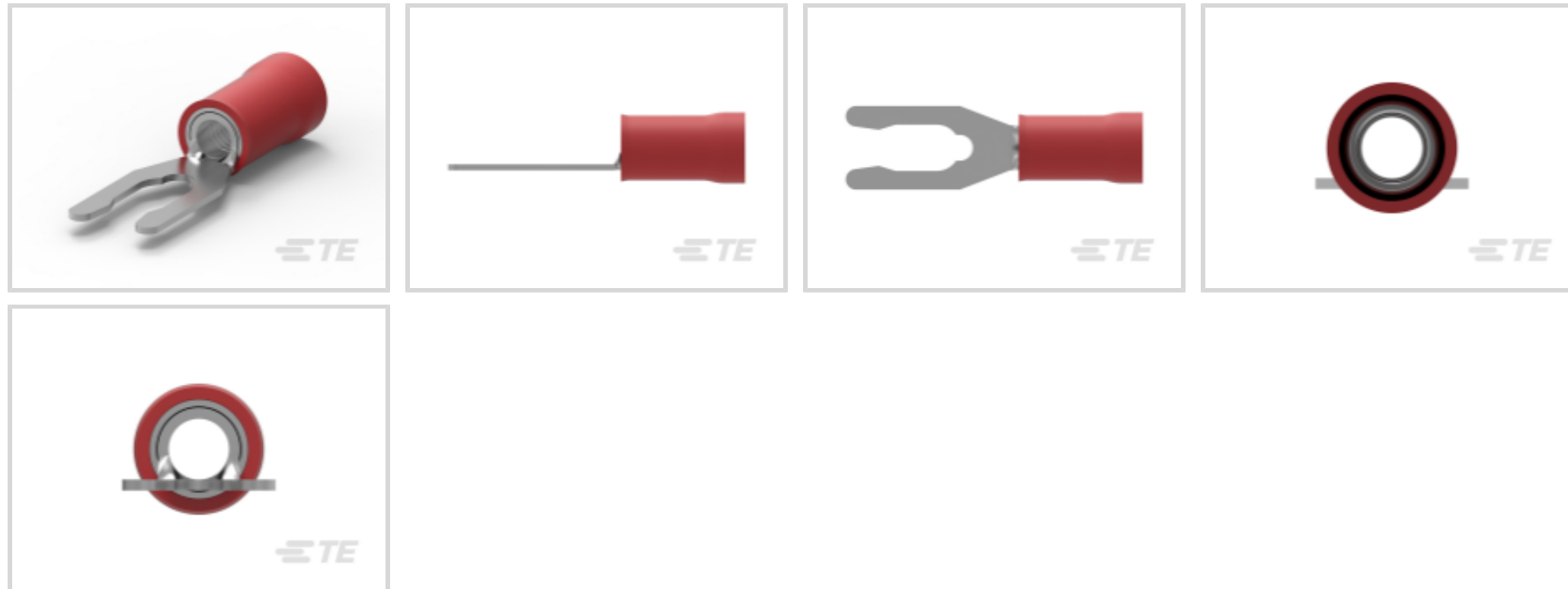

Spade Terminal Type: **Spring Spade Terminal**

Wire Size: **509 – 3260 CMA**

Stud Size: **#6, M3.5**

[All PIDG Long Spring Spade Tongue Terminals \(50\)](#)

Features

Product Type Features

Stud Size	#6, M3.5
Sealable	No
Wire Insulation Support Retention Type	Insulation Support

Electrical Characteristics

Voltage Rating	300 V
----------------	-------

Body Features

Insulation Sleeve Color	Red
Stripe Color	Red

Contact Features

Spade Terminal Type	Spring Spade Terminal
Barrel Type	Closed
Terminal Orientation	Straight
Terminal Plating Material	Tin

Mechanical Attachment



Wire Insulation Support	With
-------------------------	------

Dimensions

Wire Size	509 – 3260 CMA
Stud Diameter	3.51 mm [.138 in]
Tongue Thickness	.79 mm [.031 in]
Product Length	23.7 mm [.933 in]
Compatible Insulation Diameter (Max)	3.18 mm [.125 in]
Compatible Insulation Diameter Range	2.03 – 3.18 mm [.08 – .125 in]

Usage Conditions

Insulation Option	Partially Insulated
Operating Temperature Range	105 °C [221 °F]

Operation/Application

Compatible With Wire Base Material	Copper
Compatible With Wire Plating Material	Tin

Industry Standards

Government Qualified Terminal	No
-------------------------------	----

Packaging Features

Packaging Quantity	1000
Packaging Method	Loose Piece

Other

Terminals & Splices Comment	Marking: Commercial 22-16- Military 22-18 in accordance with MIL-T-7928.
-----------------------------	--

Product Compliance

[For compliance documentation, visit the product page on TE.com>](#)

EU RoHS Directive 2011/65/EU	Compliant
EU ELV Directive 2000/53/EC	Compliant
China RoHS 2 Directive MIIT Order No 32, 2016	No Restricted Materials Above Threshold
EU REACH Regulation (EC) No. 1907/2006	Current ECHA Candidate List: JUNE 2023 (235) Candidate List Declared Against: JUNE 2023 (235) Does not contain REACH SVHC













Halogen Content	Low Halogen - Br, Cl, F, I < 900 ppm per homogenous material. Also BFR/CFR/PVC Free
Solder Process Capability	Not applicable for solder process capability

Product Compliance Disclaimer

This information is provided based on reasonable inquiry of our suppliers and represents our current actual knowledge based on the information they provided. This information is subject to change. The part numbers that TE has identified as EU RoHS compliant have a maximum concentration of 0.1% by weight in homogenous materials for lead, hexavalent chromium, mercury, PBB, PBDE, DBP, BBP, DEHP, DIBP, and 0.01% for cadmium, or qualify for an exemption to these limits as defined in the Annexes of Directive 2011/65/EU (RoHS2). Finished electrical and electronic equipment products will be CE marked as required by Directive 2011/65/EU. Components may not be CE marked. Additionally, the part numbers that TE has identified as EU ELV compliant have a maximum concentration of 0.1% by weight in homogenous materials for lead, hexavalent chromium, and mercury, and 0.01% for cadmium, or qualify for an exemption to these limits as defined in the Annexes of Directive 2000/53/EC (ELV). Regarding the REACH Regulation, the information TE provides on SVHC in articles for this part number is based on the latest European Chemicals Agency (ECHA) 'Guidance on requirements for substances in articles' posted at this URL: <https://echa.europa.eu/guidance-documents/guidance-on-reach>

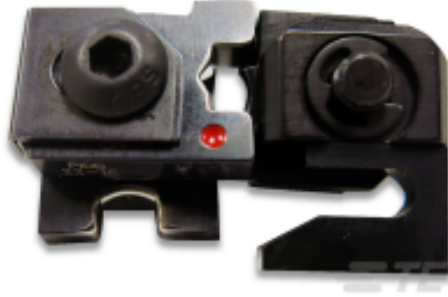
Compatible Parts

 <p>TE Part # 59824-1 TETRA-CRIMP PIDG PG FASTON 22-10 ASSY</p>	 <p>REPRESENTATION ONLY</p> <p>TE Part # 47386 DAHT PG PIDG 26-16 ASSY</p>	 <p>REPRESENTATION ONLY</p> <p>TE Part # 47386-4 DAHT PG PIDG 26-16 ASSY</p>	 <p>TE Part # 59250 T-HEAD PIDG 26-14 ASSY</p>
 <p>TE Part # 58423-1 DIE, RBY IS9252</p>	 <p>TE Part # 58433-3 PRO CR ASSY, RBY IS9252</p>	 <p>REPRESENTATION ONLY</p> <p>TE Part # 525690 DAHT PG PIDG 20-18 ASSY</p>	 <p>TE Part # 539691-2 ERGO DIE R.B.Y</p>
 <p>TE Part # 2063030-1 SDE DIESET, RBY, UL</p>	 <p>TE Part # 47806-2 DIES PIDG 22-16 DIE SET</p>	 <p>TE Part # 59300 T-HEAD PIDG PG 26-16 ASSY</p>	 <p>TE Part # 169400 CERTI-LOK FRAME W/O DIES</p>

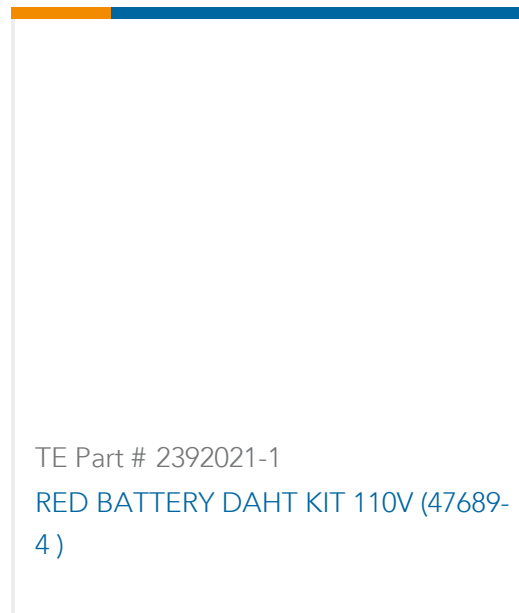
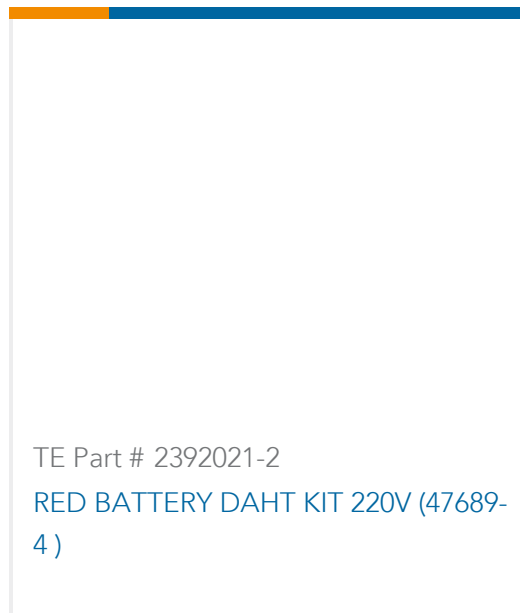

Also in the Series | PIDG

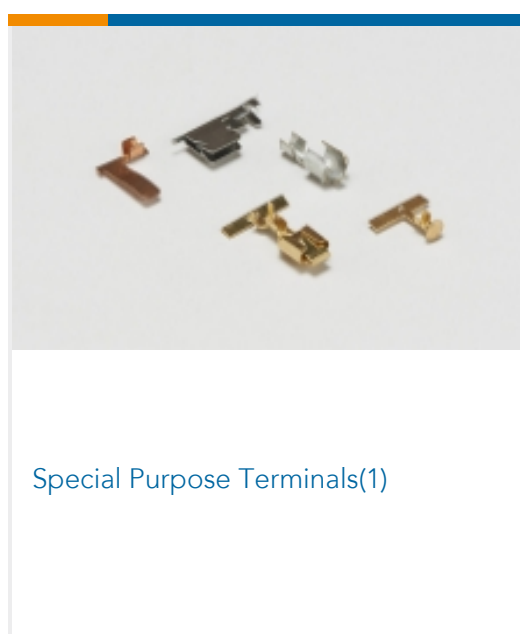
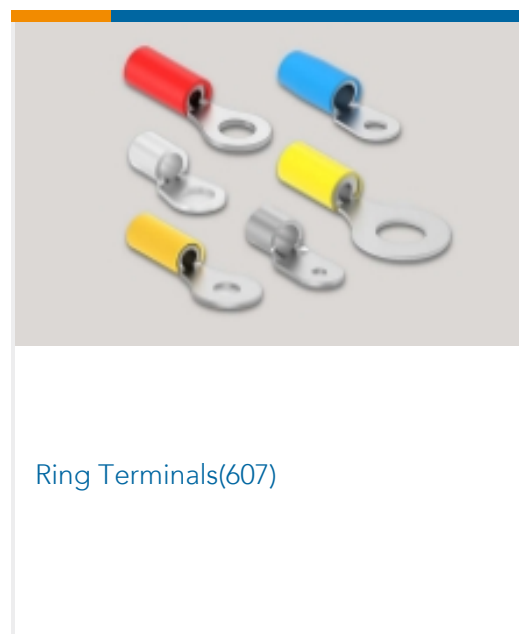
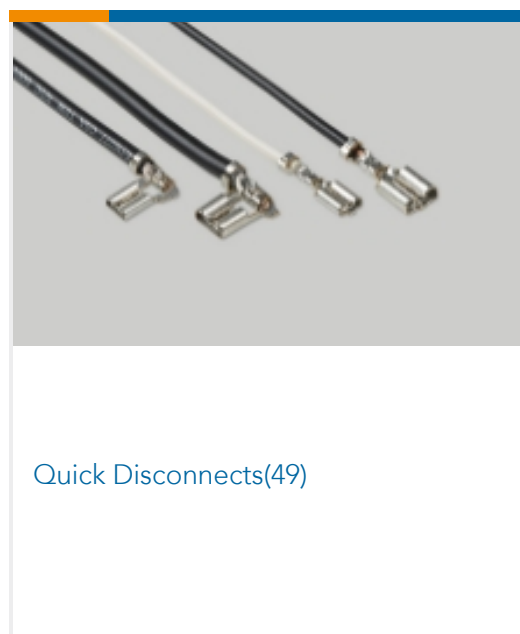
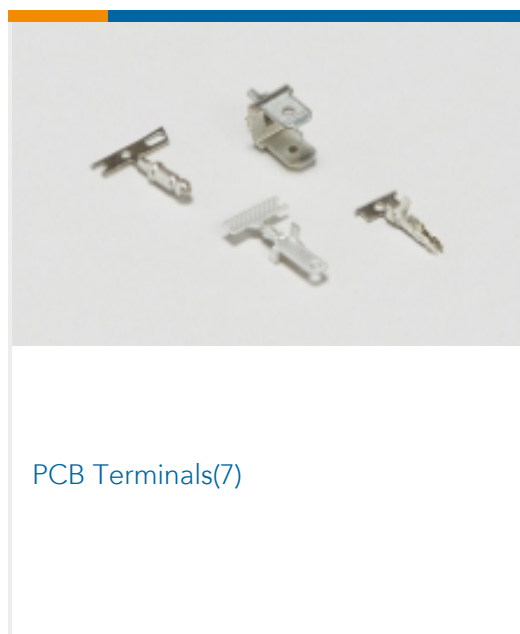
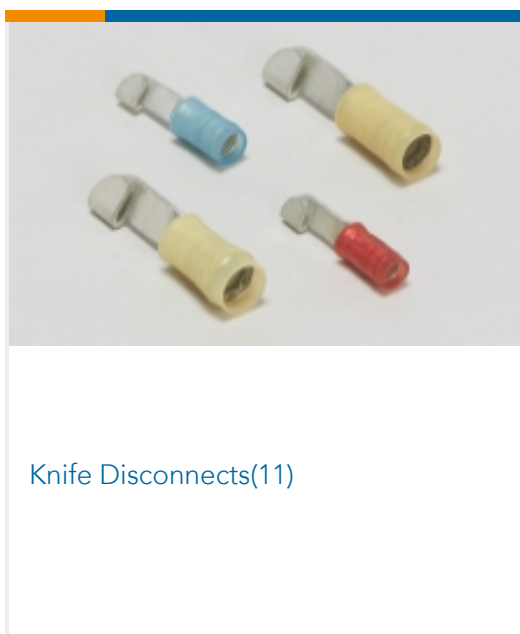
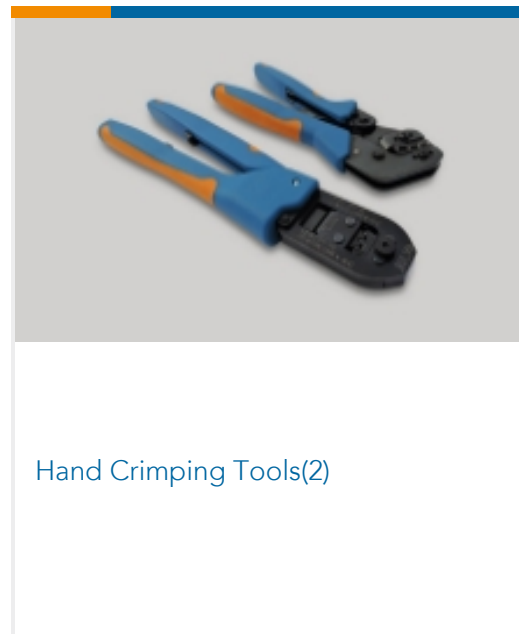
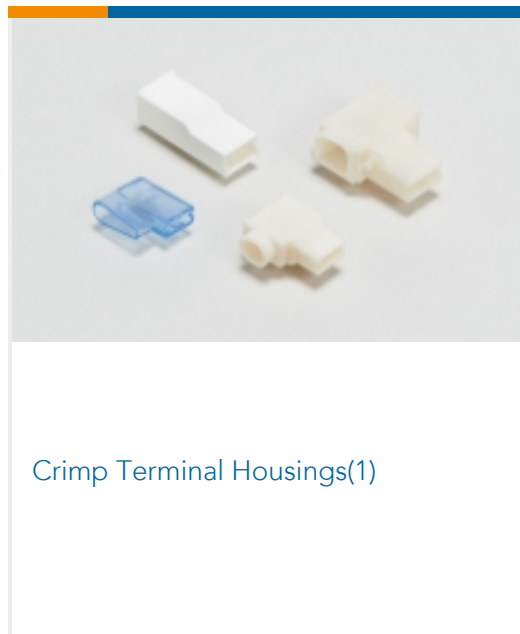
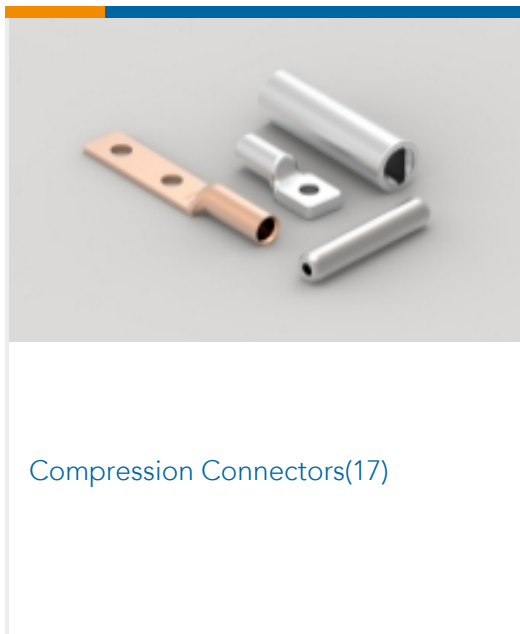

Customers Also Bought



TE Part #52928
PIDG SPRSPD 22-16COM22-18MIL 5



TE Part #350923-6
UMNLSOK 12-10 AUNI/PHBZ



TE Part #2-36195-3
SOLIS SPD 22-16COMM 22-18MIL 6



TE Part #YDTS24W11-05PNV001
RECP ASSY

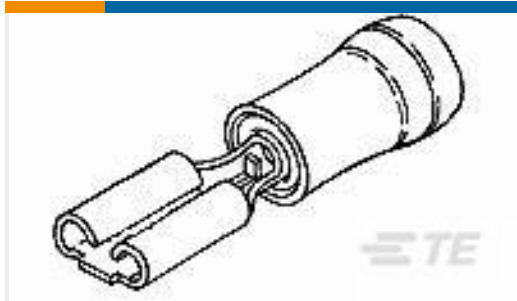

TE Part #165566-2
110 PIDG FASTON REC



TE Part #ABC06N-12P-4048
IN-LINE PLUG

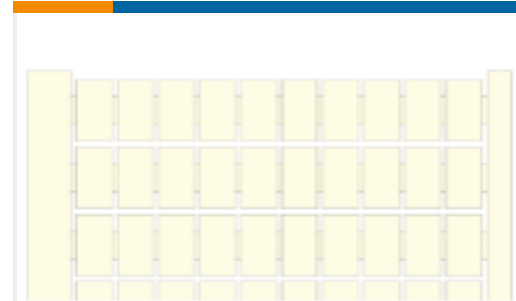

TE Part #1SNA231000R0700
RC510



TE Part #NB15272001
CRN-1/4-0-STK

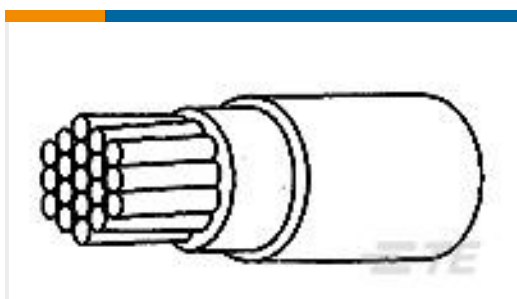

TE Part #7699133001
FLT0111-1.00-6



TE Part #5327193001
FLT0111-1.50-6

Documents

Product Drawings

[TERMINAL,PIDG SPR SPD 22-16 6](#)

English

CAD Files

[3D PDF](#)

3D

Customer View Model

[ENG_CVM_CVM_52409_J.2d_dxf.zip](#)

English

Customer View Model

[ENG_CVM_CVM_52409_J.3d_igs.zip](#)

English

Customer View Model

[ENG_CVM_CVM_52409_J.3d_stp.zip](#)

English

By downloading the CAD file I accept and agree to the [Terms and Conditions](#) of use.

Datasheets & Catalog Pages



PIDG TERMINALS & SPLICES Quick Reference Guide

English

Product Specifications

Application Specification

English

Agency Approvals

UL Report

English