



**PIDG**

TE Internal #: 52409-2

Spring Spade Terminal, 22 – 16 AWG, #6 / M3.5 Stud Size, 3.51 mm

[.138 in] Stud Diameter, Closed Barrel, Straight, Tin, Partially

Insulated, PIDG

[View on TE.com >](#)

Terminals & Splices > Spade Terminals > PIDG Long Spring Spade Tongue Terminals

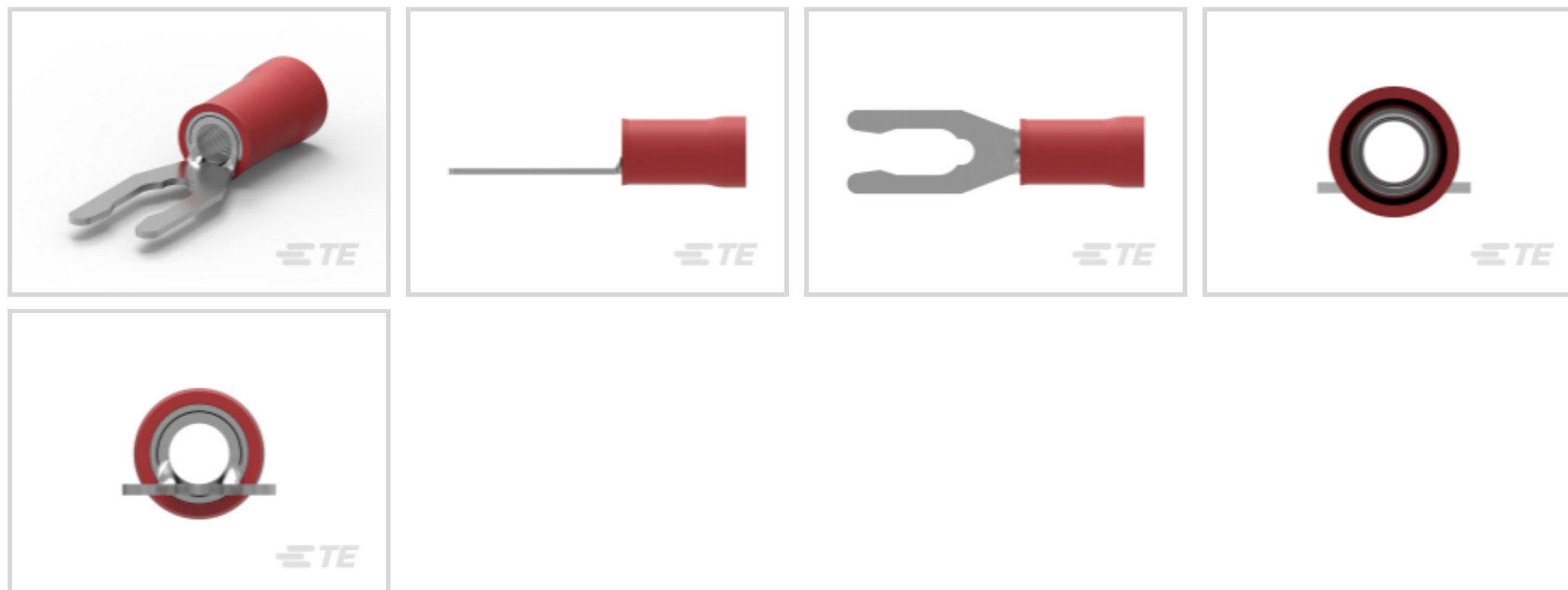

Spade Terminal Type: **Spring Spade Terminal**

Wire Size: **509 – 3260 CMA**

Stud Size: **#6, M3.5**

[All PIDG Long Spring Spade Tongue Terminals \(51\)](#)

**Features**

**Product Type Features**

Stud Size	#6, M3.5
Sealable	No
Wire Insulation Support Retention Type	Insulation Support

**Electrical Characteristics**

Voltage Rating	300 V
----------------	-------

**Body Features**

Insulation Sleeve Color	Red
Stripe Color	Red

**Contact Features**

Spade Terminal Type	Spring Spade Terminal
Barrel Type	Closed
Terminal Orientation	Straight
Terminal Plating Material	Tin

**Mechanical Attachment**



Wire Insulation Support	With
-------------------------	------

### Dimensions

Wire Size	509 – 3260 CMA
Stud Diameter	3.51 mm [.138 in]
Tongue Thickness	.79 mm [.031 in]
Product Length	23.7 mm [.933 in]
Compatible Insulation Diameter (Max)	3.56 mm [.14 in]
Compatible Insulation Diameter Range	2.67 – 3.56 mm [.105 – .14 in]

### Usage Conditions

Insulation Option	Partially Insulated
Operating Temperature Range	105 °C [221 °F]

### Operation/Application

Compatible With Wire Base Material	Copper
Compatible With Wire Plating Material	Tin

### Industry Standards

Government Qualified Terminal	No
-------------------------------	----

### Packaging Features

Packaging Quantity	5000
Packaging Method	Loose Piece

### Product Compliance

[For compliance documentation, visit the product page on TE.com>](#)

EU RoHS Directive 2011/65/EU	Compliant
EU ELV Directive 2000/53/EC	Compliant
China RoHS 2 Directive MIIT Order No 32, 2016	No Restricted Materials Above Threshold
EU REACH Regulation (EC) No. 1907/2006	Current ECHA Candidate List: JUNE 2023 (235) Candidate List Declared Against: JUNE 2023 (235) Does not contain REACH SVHC
Halogen Content	Low Halogen - Br, Cl, F, I < 900 ppm per homogenous material. Also BFR/CFR/PVC Free
Solder Process Capability	Not applicable for solder process capability

### Product Compliance Disclaimer

This information is provided based on reasonable inquiry of our suppliers and represents our current actual knowledge based on the information they provided. This information is subject to change. The part numbers that TE has identified as EU RoHS compliant have a maximum concentration of 0.1% by weight in homogenous materials for lead, hexavalent chromium, mercury, PBB, PBDE, DBP, BBP, DEHP, DIBP, and 0.01% for cadmium, or qualify for an exemption to these limits as defined in the Annexes of Directive 2011/65/EU (RoHS2). Finished electrical and electronic equipment products will be CE marked as required by Directive 2011/65/EU. Components may not be CE marked. Additionally, the part numbers that TE has identified as EU ELV compliant have a maximum concentration of 0.1% by weight in homogenous materials for lead, hexavalent chromium, and mercury, and 0.01% for cadmium, or qualify for an exemption to these limits as defined in the Annexes of Directive 2000/53/EC (ELV). Regarding the REACH Regulation, the information TE provides on SVHC in articles for this part number is based on the latest European Chemicals Agency (ECHA) 'Guidance on requirements for substances in articles' posted at this URL: <https://echa.europa.eu/guidance-documents/guidance-on-reach>

## Compatible Parts



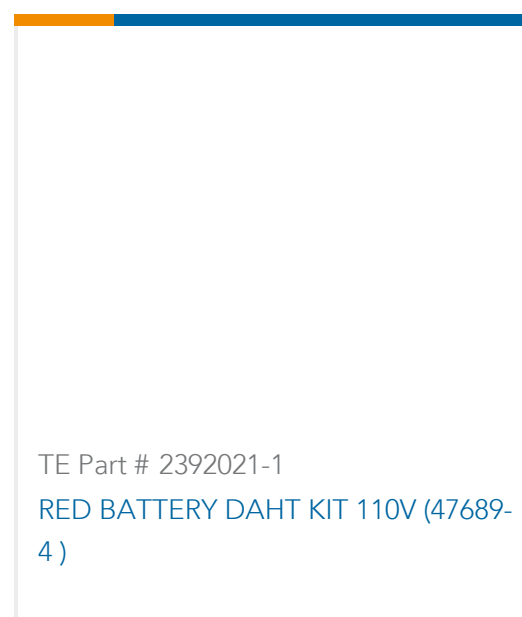
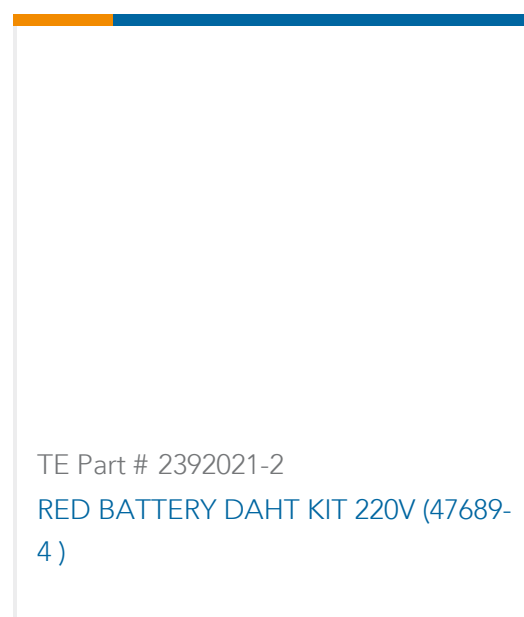

Also in the Series | PIDG

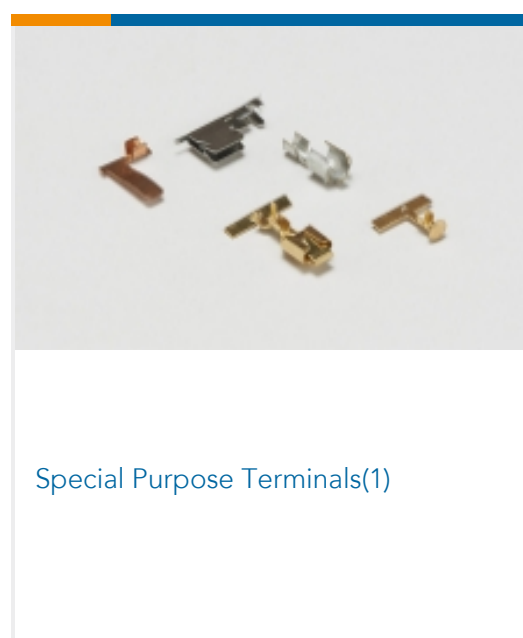
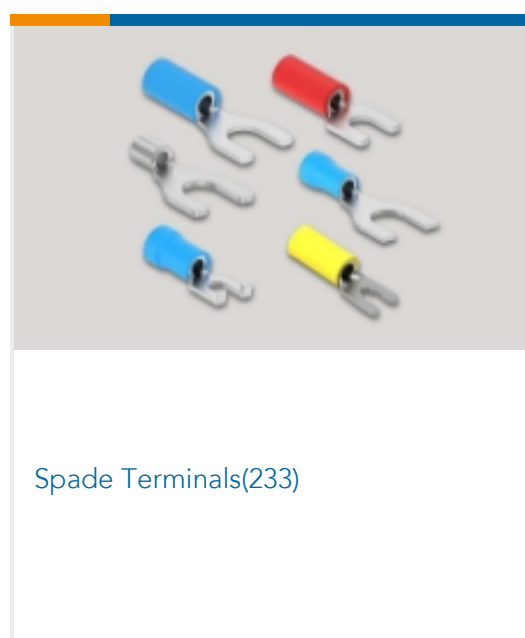
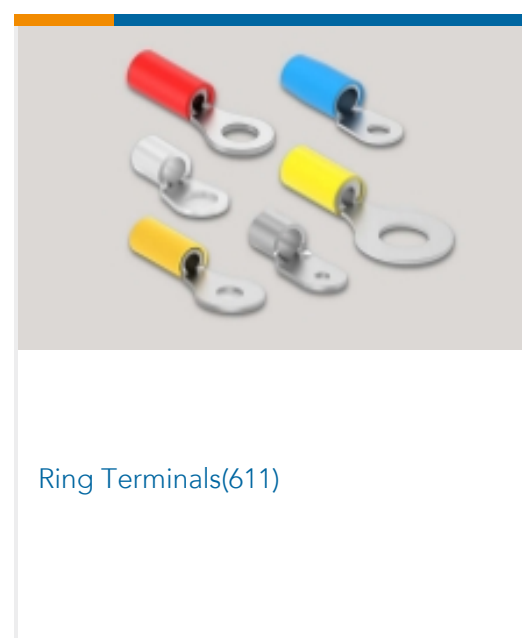
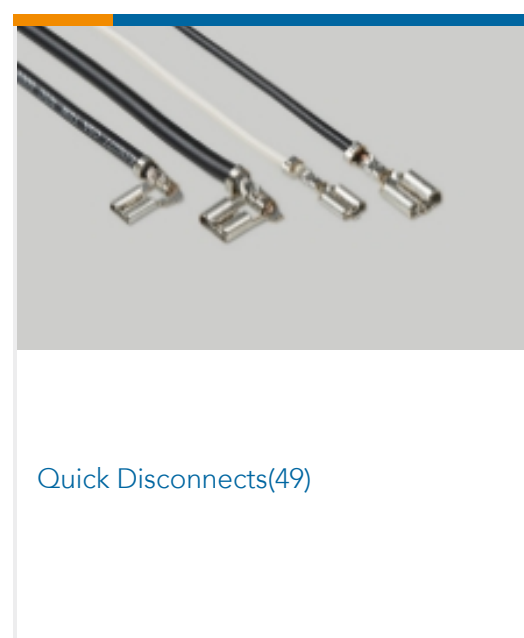
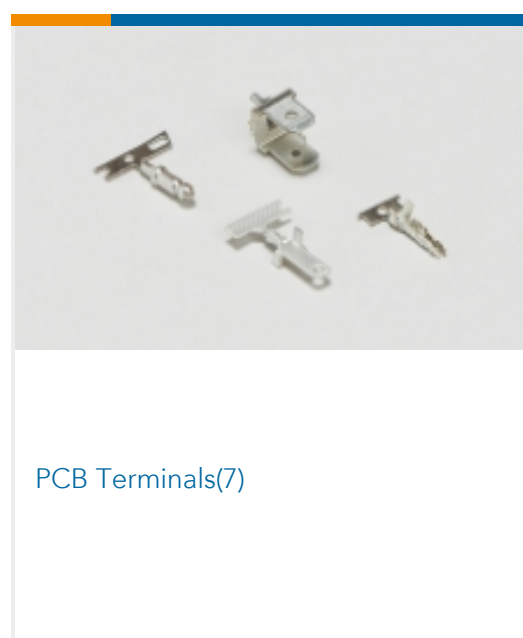
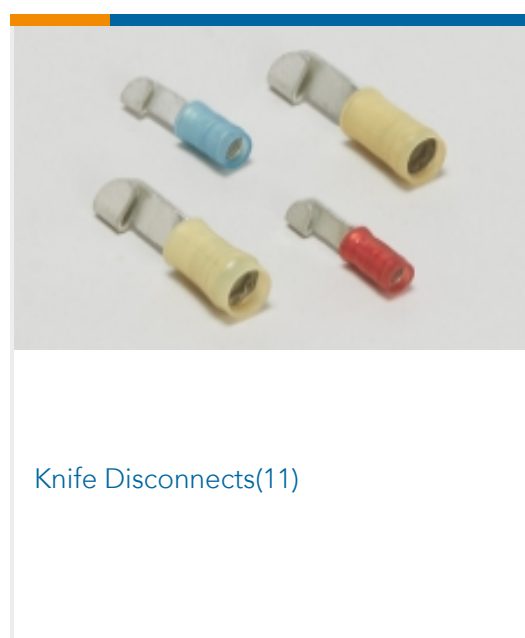
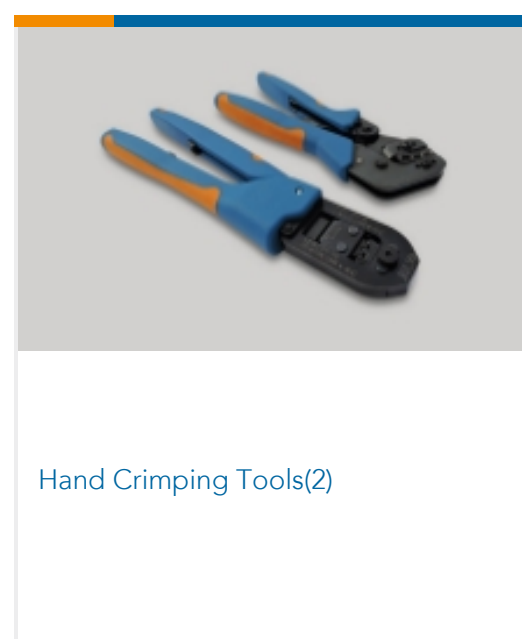
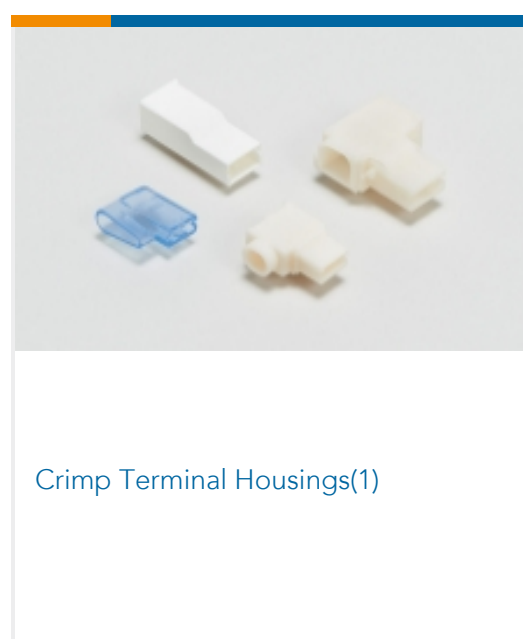
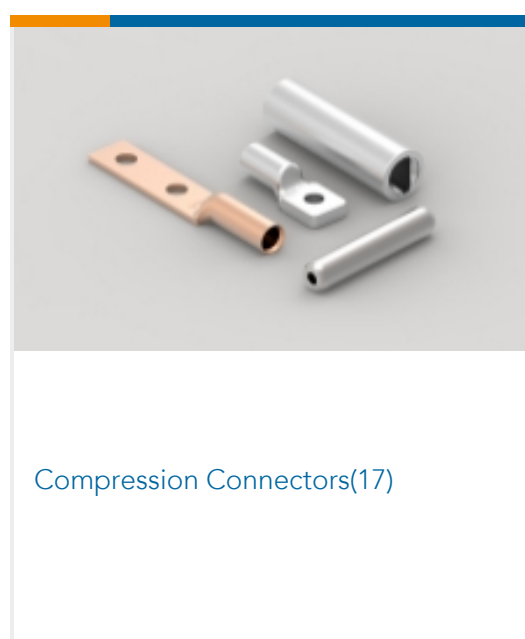

Customers Also Bought





TE Part #205210-8  
PLUG ASSY SIZE 4

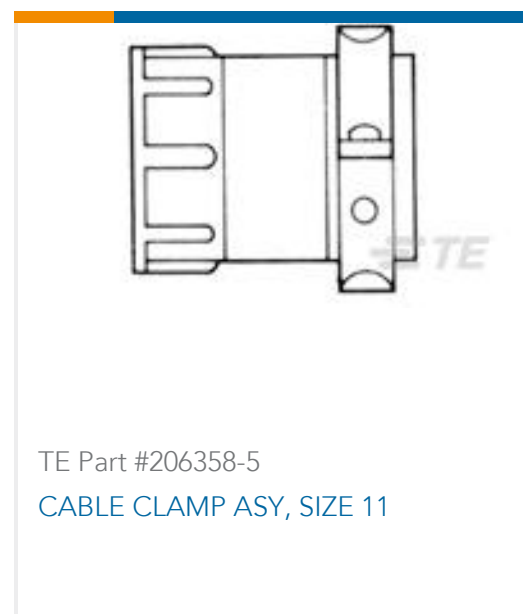

TE Part #206358-5  
CABLE CLAMP ASY, SIZE 11

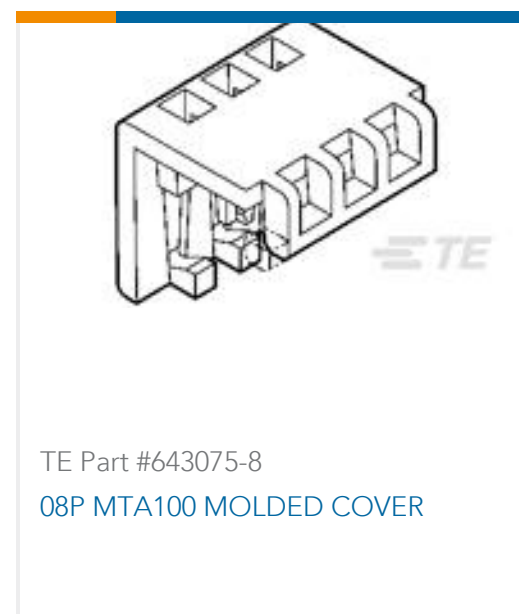

TE Part #643075-8  
08P MTA100 MOLDED COVER



TE Part #36254  
PIDG Ring Tongue Terminals



TE Part #66506-4  
HD 20 DF PIN PLTD



TE Part #52922  
PIDG Long Spring Spade Tongue  
Terminals



TE Part #6-1879209-3  
CPF 0402 49R9 0.1% 25PPM 5K RL

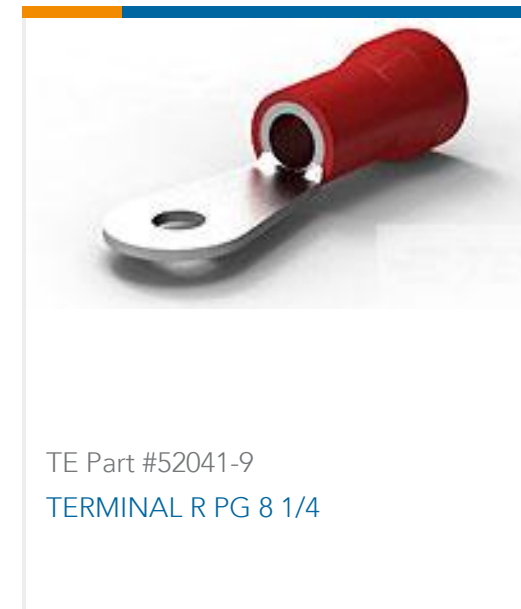

TE Part #52041-9  
TERMINAL R PG 8 1/4

## Documents

### Product Drawings

[PIDG SP SPD 22-16COM22-18MIL 6](#)

English

### CAD Files

[3D PDF](#)

3D

Customer View Model

[ENG\\_CVM\\_CVM\\_52409-2\\_J.2d\\_dxf.zip](#)

English

Customer View Model

[ENG\\_CVM\\_CVM\\_52409-2\\_J.3d\\_igs.zip](#)

English

Customer View Model

[ENG\\_CVM\\_CVM\\_52409-2\\_J.3d\\_stp.zip](#)

English

By downloading the CAD file I accept and agree to the [Terms and Conditions](#) of use.

### Product Specifications

[Application Specification](#)

English