

52266-1 ✓ ACTIVE

PLASTI-GRIP

TE Internal #: 52266-1

Closed Ring Tongue Terminal, 4 AWG, 3/8 Stud Size, 9.53 mm / 9.91 mm [.39 in] Stud Diameter, Closed Barrel, Straight, Tin, PLASTI-GRIP

[View on TE.com >](#)



Terminals & Splices > Ring Terminals

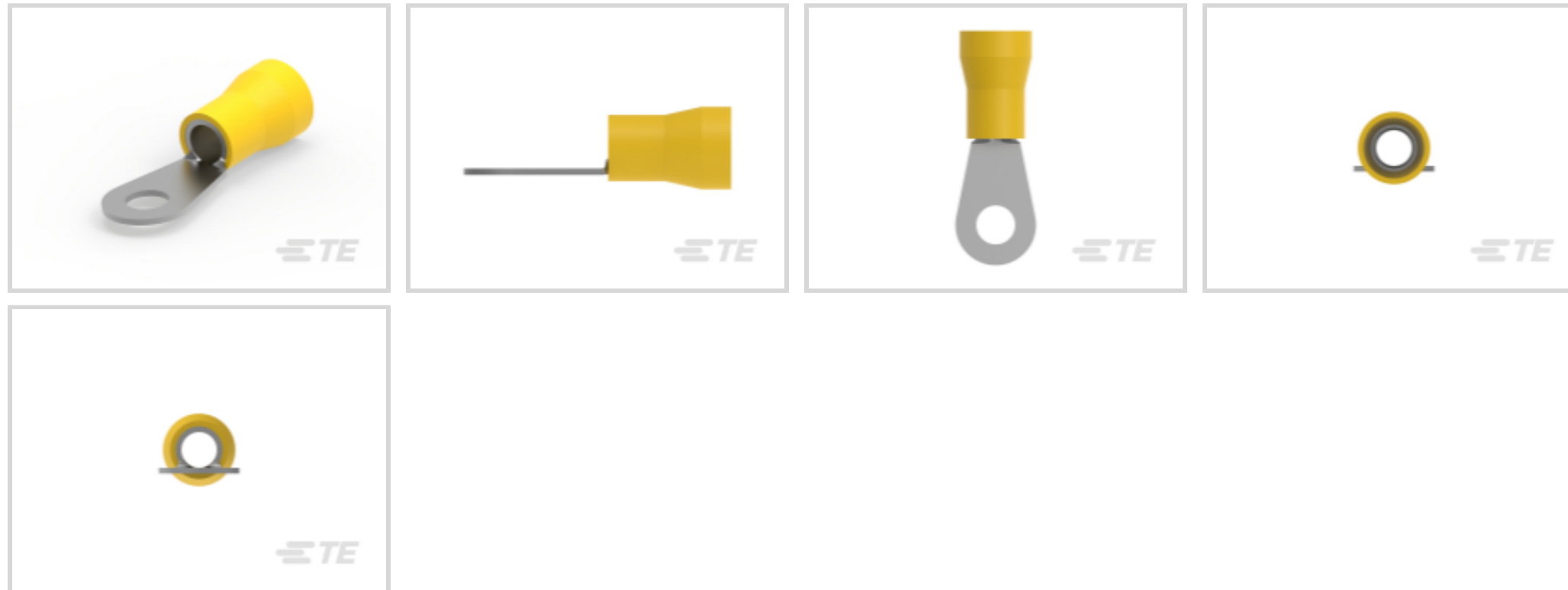

Ring Terminal Product Type: Closed Ring Tongue Terminal

Wire Size: 33100 – 52600 CMA

Stud Size: 3/8

### Features

#### Product Type Features

Ring Terminal Product Type	Closed Ring Tongue Terminal
Stud Size	3/8
Sealable	No
Wire Insulation Support Retention Type	Insulation Support

#### Configuration Features

Number of Holes	1
-----------------	---

#### Electrical Characteristics

Voltage Rating	600 V
----------------	-------

#### Body Features

Insulation Sleeve Color	Yellow
Stripe Color	Yellow

#### Contact Features

Barrel Type	Closed
Terminal Orientation	Straight
Terminal Plating Material	Tin



### Mechanical Attachment

Wire Insulation Support	With
-------------------------	------

### Dimensions

Wire Size	33100 – 52600 CMA
Stud Diameter	9.53 mm, 9.91 mm [.39 in]
Tongue Thickness	.79 mm [.031 in]
Product Length	51.2 mm [2.014 in]
Compatible Insulation Diameter (Max)	13.08 mm [.515 in]
Compatible Insulation Diameter Range	13.08 mm [.515 in]

### Usage Conditions

Insulation Option	Partially Insulated
Operating Temperature Range	90 °C [194 °F]

### Operation/Application

Compatible With Wire Base Material	Copper
Compatible With Wire Plating Material	Tin

### Industry Standards

Government Qualified Terminal	No
-------------------------------	----

### Packaging Features

Packaging Quantity	100
Packaging Method	Loose Piece

### Product Compliance

[For compliance documentation, visit the product page on TE.com>](#)

EU RoHS Directive 2011/65/EU	Compliant
EU ELV Directive 2000/53/EC	Compliant
China RoHS 2 Directive MIIT Order No 32, 2016	No Restricted Materials Above Threshold
EU REACH Regulation (EC) No. 1907/2006	Current ECHA Candidate List: JUNE 2023 (235) Candidate List Declared Against: JUNE 2023 (235) Does not contain REACH SVHC
Halogen Content	Not Low Halogen - contains Br or Cl > 900 ppm.
Solder Process Capability	Not applicable for solder process capability

## Product Compliance Disclaimer

This information is provided based on reasonable inquiry of our suppliers and represents our current actual knowledge based on the information they provided. This information is subject to change. The part numbers that TE has identified as EU RoHS compliant have a maximum concentration of 0.1% by weight in homogenous materials for lead, hexavalent chromium, mercury, PBB, PBDE, DBP, BBP, DEHP, DIBP, and 0.01% for cadmium, or qualify for an exemption to these limits as defined in the Annexes of Directive 2011/65/EU (RoHS2). Finished electrical and electronic equipment products will be CE marked as required by Directive 2011/65/EU. Components may not be CE marked. Additionally, the part numbers that TE has identified as EU ELV compliant have a maximum concentration of 0.1% by weight in homogenous materials for lead, hexavalent chromium, and mercury, and 0.01% for cadmium, or qualify for an exemption to these limits as defined in the Annexes of Directive 2000/53/EC (ELV). Regarding the REACH Regulation, the information TE provides on SVHC in articles for this part number is based on the latest European Chemicals Agency (ECHA) 'Guidance on requirements for substances in articles' posted at this URL: <https://echa.europa.eu/guidance-documents/guidance-on-reach>

## Compatible Parts

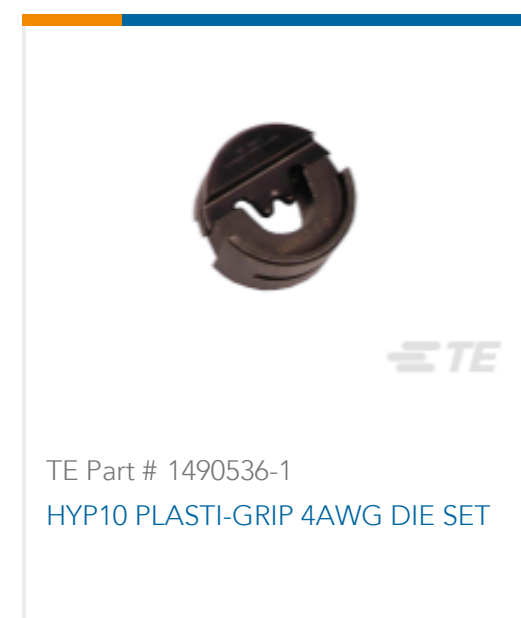

## Also in the Series | PLASTI-GRIP

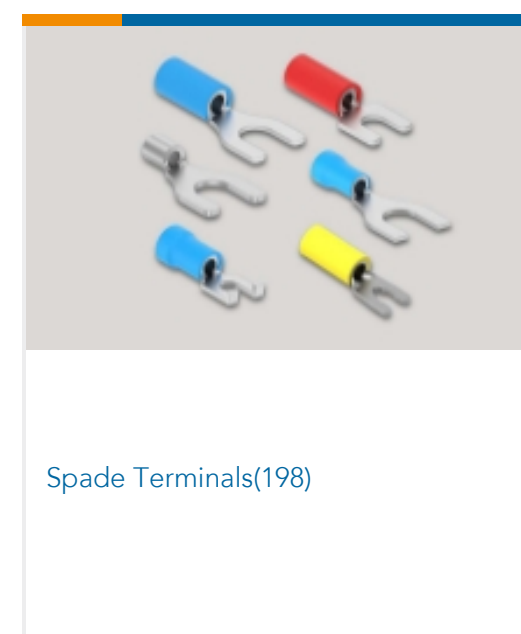
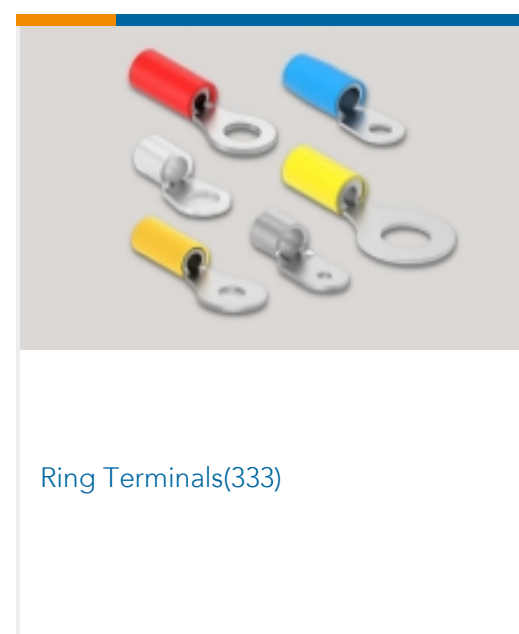
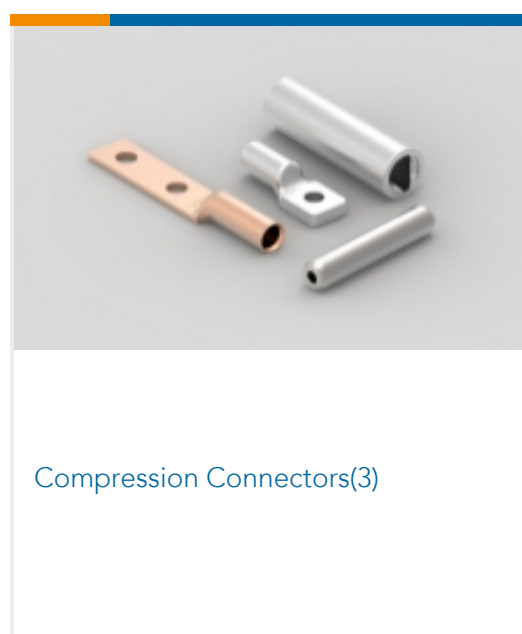



Splices(50)

## Customers Also Bought

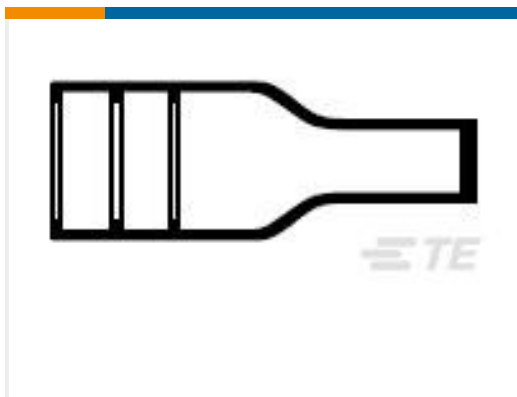
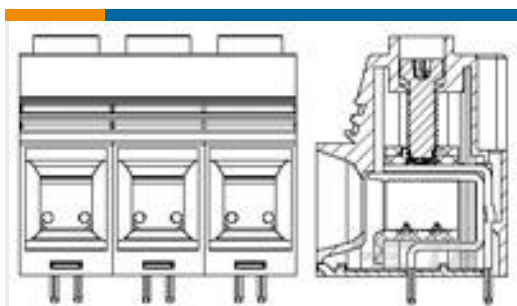
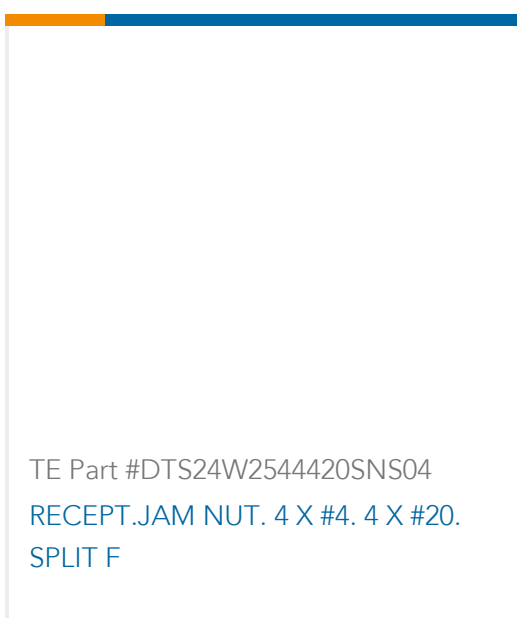
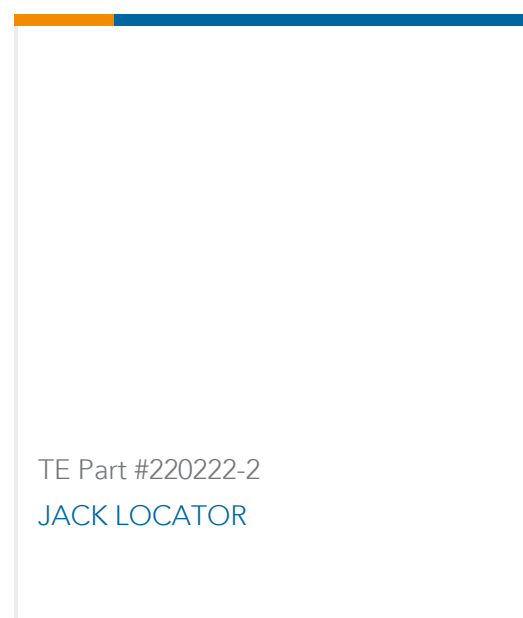
TE Part #808980-000  
202D132-3/42-0TE Part #2-1879215-1  
CPF 0402 6K49 0.1% 25PPM 1K RLTE Part #YDTS24W17-35PNV001  
RECP ASSYTE Part #YD369-P33-AS300000  
369 3 WAY PLUG, 20/22 CONTACTS,  
SKTTE Part #1986242-4  
Power Connector, 15.0mm, Green, 4  
posnTE Part #YDTS26W2544420PN04  
PLUG ASSY.HIGH CURRENT.TE Part #YDTS32Z15NV0010000  
CAP ASSEMBLYTE Part #ZPF000000000167207  
DTS 20 B 11-99 PNTE Part #DTS24W2544420SNS04  
RECEPT.JAM NUT. 4 X #4. 4 X #20.  
SPLIT FTE Part #220222-2  
JACK LOCATOR

## Documents

### Product Drawings

[TERMINAL R PG 4 3/8](#)

English

### CAD Files

[3D PDF](#)

3D

[Customer View Model](#)

[ENG\\_CVM\\_CVM\\_52266-1\\_V.2d\\_dxf.zip](#)



English

**Customer View Model**

[ENG\\_CVM\\_CVM\\_52266-1\\_V.3d\\_igs.zip](#)

English

**Customer View Model**

[ENG\\_CVM\\_CVM\\_52266-1\\_V.3d\\_stp.zip](#)

English

By downloading the CAD file I accept and agree to the [Terms and Conditions](#) of use.

---

**Product Specifications**

[Application Specification](#)

English

---

**Instruction Sheets**

[Instruction Sheet \(U.S.\)](#)

English

---

**Agency Approvals**

[UL Report](#)

English

[UL Report](#)

English