

52263 ✓ ACTIVE

PLASTI-GRIP

TE Internal #: 52263

Closed Ring Tongue Terminal, 8 AWG, #10 Stud Size, 5 mm [.197 in] Stud Diameter, Closed Barrel, Straight, Tin, Partially Insulated, PLASTI-GRIP

[View on TE.com >](#)



Terminals & Splices > Ring Terminals

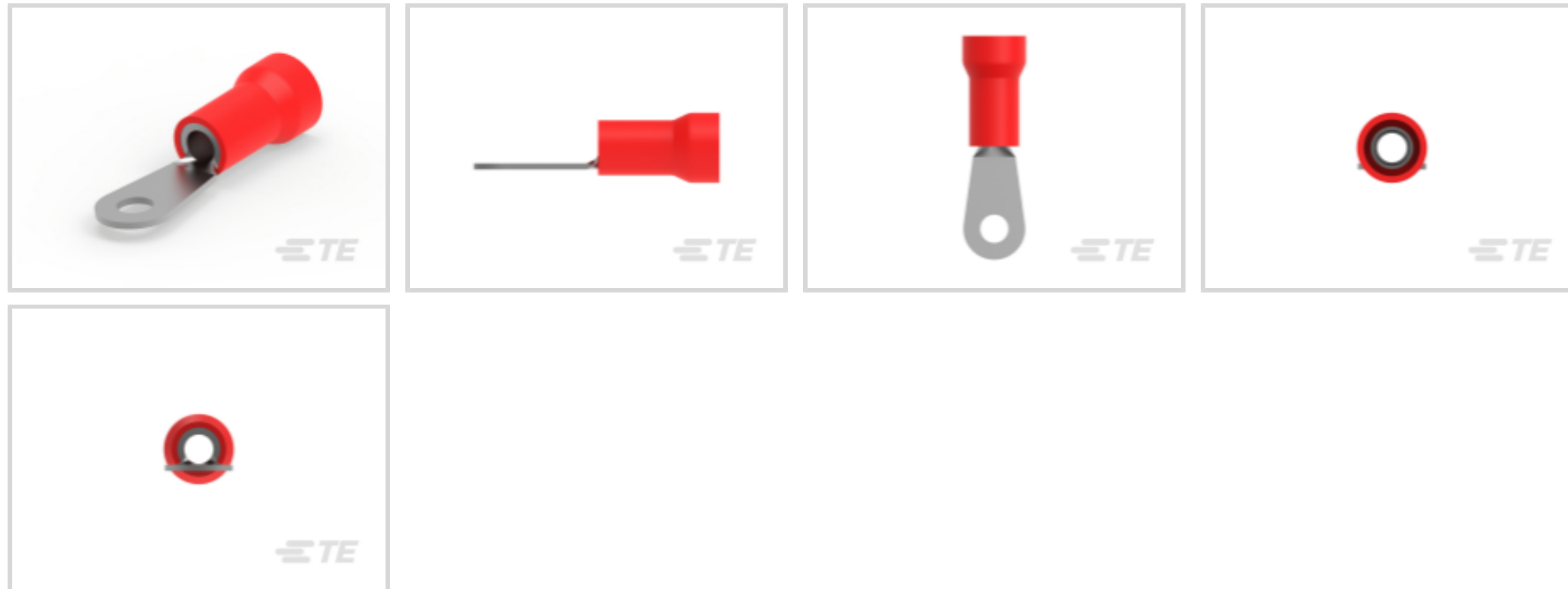

Ring Terminal Product Type: Closed Ring Tongue Terminal

Wire Size: 13100 – 20800 CMA

Stud Size: #10

Features

Product Type Features

Ring Terminal Product Type	Closed Ring Tongue Terminal
Stud Size	#10
Sealable	No
Wire Insulation Support Retention Type	Insulation Support

Configuration Features

Number of Holes	1
-----------------	---

Electrical Characteristics

Voltage Rating	600 V
----------------	-------

Contact Features

Barrel Type	Closed
Terminal Orientation	Straight
Terminal Plating Material	Tin

Mechanical Attachment

Wire Insulation Support	With
-------------------------	------

Dimensions



Wire Size	13100 – 20800 CMA
Stud Diameter	5 mm [.197 in]
Tongue Thickness	1.02 mm [.04 in]
Product Length	4.75 mm [.187 in]
Compatible Insulation Diameter (Max)	9.14 mm [.36 in]
Compatible Insulation Diameter Range	9.14 mm [.36 in]

Usage Conditions

Insulation Option	Partially Insulated
Operating Temperature Range	105 °C [221 °F]

Operation/Application

Compatible With Wire Base Material	Copper
Compatible With Wire Plating Material	Tin

Industry Standards

Government Qualified Terminal	No
-------------------------------	----

Packaging Features

Packaging Quantity	100
Packaging Method	Loose Piece

Product Compliance

[For compliance documentation, visit the product page on TE.com>](#)

EU RoHS Directive 2011/65/EU	Compliant
EU ELV Directive 2000/53/EC	Compliant
China RoHS 2 Directive MIIT Order No 32, 2016	No Restricted Materials Above Threshold
EU REACH Regulation (EC) No. 1907/2006	Current ECHA Candidate List: JUNE 2023 (235) Candidate List Declared Against: JUNE 2023 (235) Does not contain REACH SVHC
Halogen Content	Not Low Halogen - contains Br or Cl > 900 ppm.
Solder Process Capability	Not applicable for solder process capability

Product Compliance Disclaimer

This information is provided based on reasonable inquiry of our suppliers and represents our current actual knowledge based on the information they provided. This information is subject to change. The part numbers that TE has identified as EU RoHS compliant have a maximum concentration of 0.1% by weight in homogenous materials for lead, hexavalent

chromium, mercury, PBB, PBDE, DBP, BBP, DEHP, DIBP, and 0.01% for cadmium, or qualify for an exemption to these limits as defined in the Annexes of Directive 2011/65/EU (RoHS2). Finished electrical and electronic equipment products will be CE marked as required by Directive 2011/65/EU. Components may not be CE marked. Additionally, the part numbers that TE has identified as EU ELV compliant have a maximum concentration of 0.1% by weight in homogenous materials for lead, hexavalent chromium, and mercury, and 0.01% for cadmium, or qualify for an exemption to these limits as defined in the Annexes of Directive 2000/53/EC (ELV). Regarding the REACH Regulation, the information TE provides on SVHC in articles for this part number is based on the latest European Chemicals Agency (ECHA) 'Guidance on requirements for substances in articles' posted at this URL: <https://echa.europa.eu/guidance-documents/guidance-on-reach>

Compatible Parts



TE Part # 59974-1
HYP8 8-2AWG MANUAL TOOL-No Dies



TE Part # 47820
HYP8 TERMINYL 8AWG DIE SET



TE Part # 1490597-1
HYP10 TERMINYL 8AWG DIE SET



TE Part # 1490534-1
HYP10 PLASTI-GRIP 8AWG DIE SET

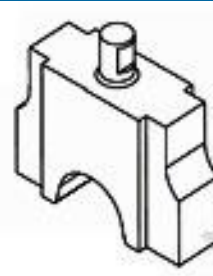

TE Part # 1901006-1
ASSEMBLY, TERMINYL DIE #8



TE Part # 48752-1
HYP8 PLASTI-GRIP 8AWG 69051 DIE SET



TE Part # 48858-1
HYP8/10 PLASTI-GRIP/10 8AWG DIE SET

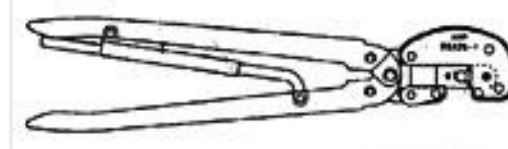

TE Part # 69959
HHHT AMPLI-BOND PG 8 ASSY SET

Also in the Series | PLASTI-GRIP



Compression Connectors(3)



Crimp Wire Pins, Tabs & Ferrules(25)



Ring Terminals(333)

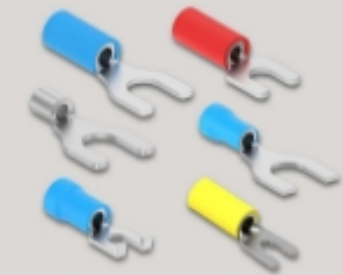

Spade Terminals(198)



Splices(50)

Customers Also Bought



TE Part #552319-1
ASSY, PLUG, 50 POS, C SLOT



TE Part #52044-1
TERMINAL R PG 2 5/16

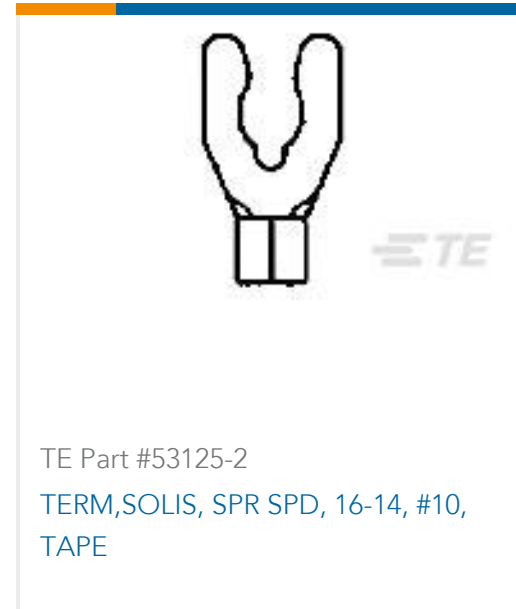

TE Part #53125-2
TERM,SOLIS, SPR SPD, 16-14, #10,
TAPE



TE Part #569336-3
COVER KIT,120DEG.,CHAMP SYS 5



TE Part #1-6600132-5
MBXL R/A HDR DB 2ACP + 12S + 1P



TE Part #1546310-5
5P .563" DR BARRIER STRIP

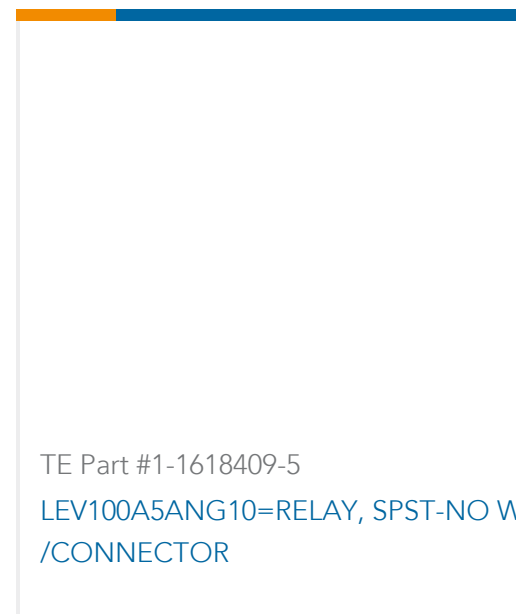

TE Part #1-1618409-5
LEV100A5ANG10=RELAY, SPST-NO W
/CONNECTOR

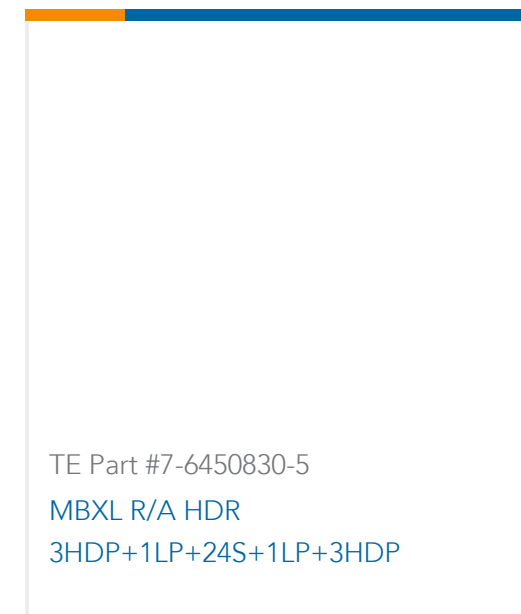

TE Part #7-6450830-5
MBXL R/A HDR
3HDP+1LP+24S+1LP+3HDP

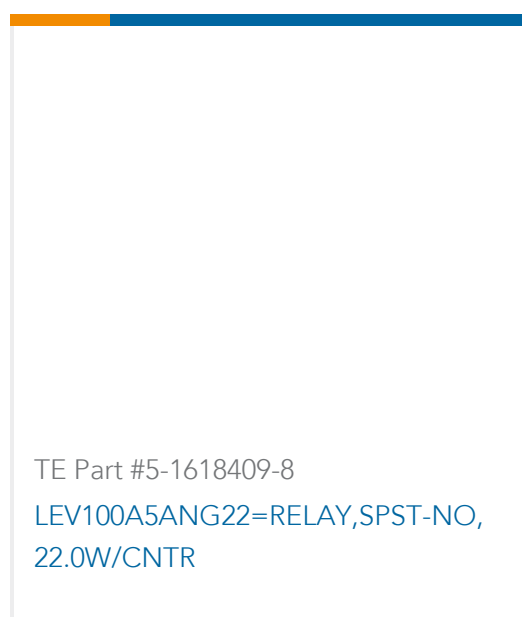

TE Part #5-1618409-8
LEV100A5ANG22=RELAY,SPST-NO,
22.0W/CNTR

Documents

Product Drawings

[TERMINAL R PG 8 10](#)

English

CAD Files

Customer View Model

[ENG_CVM_CVM_52263_AA.2d_dxf.zip](#)

English

[3D PDF](#)

3D

Customer View Model

[ENG_CVM_CVM_52263_AA.3d_igs.zip](#)

English

Customer View Model

[ENG_CVM_CVM_52263_AA.3d_stp.zip](#)

English

By downloading the CAD file I accept and agree to the [Terms and Conditions](#) of use.



Product Specifications

[Application Specification](#)

English

Product Environmental Compliance

[MD_52263_12052016354_dmtec](#)

English

[MD_52263_12052016354_dmtec](#)

English

Instruction Sheets

[Instruction Sheet \(U.S.\)](#)

English

Agency Approvals

[UL Report](#)

English

[UL Report](#)

English