

5223986-8 ✓ ACTIVE

Z-PACK 2mm HM

TE Internal #: 5223986-8

Backplane Guide Hardware, Guide Socket Module, Z-PACK 2mm HM

[View on TE.com >](#)



Connectors > PCB Connectors > Backplane Connectors > Backplane Guide Hardware

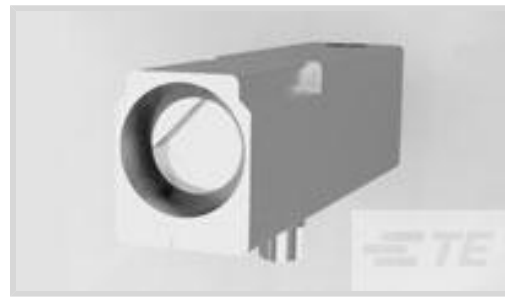

Connector Guide Hardware Type: **Guide Socket Module**

Features

Product Type Features

Connector Guide Hardware Type	Guide Socket Module
-------------------------------	---------------------

Configuration Features

Key Orientation	315°
PCB Mount Orientation	Right Angle

Body Features

Guide Component Plating Material Finish Process	Chromate Conversion Coating
Guide Component Base Material	Zinc Alloy Die Casting

Termination Features

Compatible With Backplane Interface Type	2mm HM
--	--------

Mechanical Attachment

Mating Alignment Type	Keyed
Mating Alignment	With

Dimensions

Product Length	34.2 mm
----------------	---------

Packaging Features

Packaging Quantity	1
Packaging Method	Box

Product Compliance

[For compliance documentation, visit the product page on TE.com>](#)

EU RoHS Directive 2011/65/EU	Compliant
------------------------------	-----------



EU ELV Directive 2000/53/EC	Compliant
China RoHS 2 Directive MIIT Order No 32, 2016	No Restricted Materials Above Threshold
EU REACH Regulation (EC) No. 1907/2006	Current ECHA Candidate List: JUNE 2023 (235) Candidate List Declared Against: JUNE 2023 (235) Does not contain REACH SVHC
Halogen Content	Low Halogen - Br, Cl, F, I < 900 ppm per homogenous material. Also BFR/CFR/PVC Free
Solder Process Capability	Not applicable for solder process capability

Product Compliance Disclaimer

This information is provided based on reasonable inquiry of our suppliers and represents our current actual knowledge based on the information they provided. This information is subject to change. The part numbers that TE has identified as EU RoHS compliant have a maximum concentration of 0.1% by weight in homogenous materials for lead, hexavalent chromium, mercury, PBB, PBDE, DBP, BBP, DEHP, DIBP, and 0.01% for cadmium, or qualify for an exemption to these limits as defined in the Annexes of Directive 2011/65/EU (RoHS2). Finished electrical and electronic equipment products will be CE marked as required by Directive 2011/65/EU. Components may not be CE marked. Additionally, the part numbers that TE has identified as EU ELV compliant have a maximum concentration of 0.1% by weight in homogenous materials for lead, hexavalent chromium, and mercury, and 0.01% for cadmium, or qualify for an exemption to these limits as defined in the Annexes of Directive 2000/53/EC (ELV). Regarding the REACH Regulation, the information TE provides on SVHC in articles for this part number is based on the latest European Chemicals Agency (ECHA) 'Guidance on requirements for substances in articles' posted at this URL: <https://echa.europa.eu/guidance-documents/guidance-on-reach>

Compatible Parts



TE Part # 1469265-8
UPM R/A KEYED GUIDE PIN



TE Part # 2187808-1
SW PIR RECT, 92OHM, 6X6 GR



TE Part # 1-5223985-0
UPM KEYED GUIDE PIN Internal #6-32

Also in the Series | Z-PACK 2mm HM



Backplane Coding Keys(60)

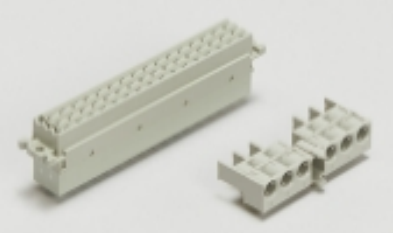

Backplane Connector Housings(4)



Backplane Guide Hardware(37)

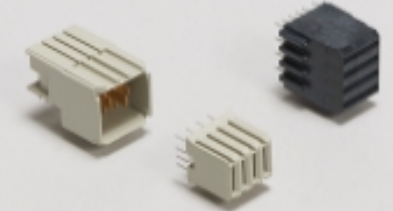

Backplane Power Connectors(6)



Board-to-Board Connector Contacts(2)

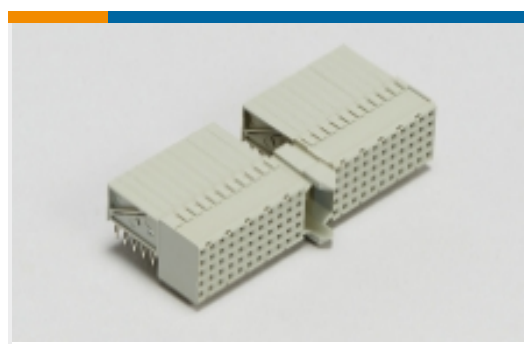

Hard Metric Backplane Connectors (269)

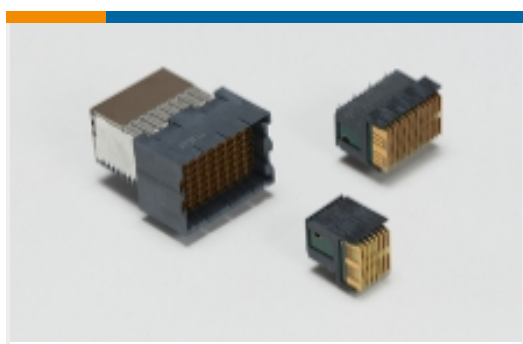

High Speed Backplane Connectors(1)



Insertion & Extraction Tools(2)

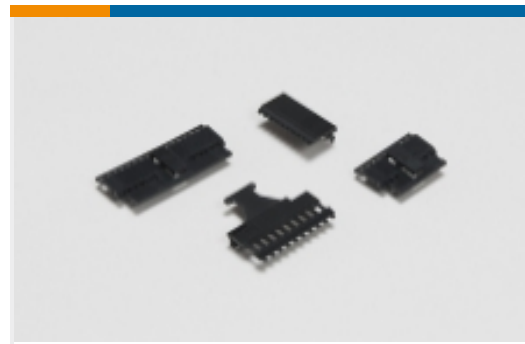

PCB Connector Covers(4)



PCB Connector Shrouds(39)



PCB Ferrules & Shields(19)



Rectangular Power Connectors(87)

Customers Also Bought



TE Part #206070-8
CABLE CLAMP KIT #17



TE Part #DT04-2P
REC, 2P, GRY, N



TE Part #DT06-2S
PLG, 2P, GRY, N



TE Part #W2P
Wedgelocks: DEUTSCH DT



TE Part #0462-201-16141
DEUTSCH Solid Contacts



TE Part #282080-1
AMP SUPERSEAL 1.5MM,
CONNECTOR HOUSING

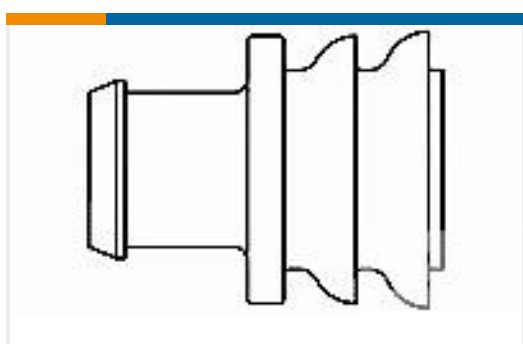

TE Part #281934-2
SINGLE WIRE SEAL

Documents

Product Drawings

UPM KEYED GUIDE MODULE

English

CAD Files

3D PDF

3D

Customer View Model

ENG_CVM_CVM_5223986-8_A.2d_dxf.zip



English

Customer View Model

[ENG_CVM_CVM_5223986-8_A.3d_igs.zip](#)

English

Customer View Model

[ENG_CVM_CVM_5223986-8_A.3d_stp.zip](#)

English

By downloading the CAD file I accept and agree to the [Terms and Conditions](#) of use.

Datasheets & Catalog Pages

[High Speed Backplane Connectors catalog - Z-PACK HS3 Connector](#)

English

[2_PIECE_POWER_CONNECTORS_qrg_4-1773458-1](#)

English

Product Specifications

[Engineering Report](#)

English

Product Environmental Compliance

[TE Material Declaration](#)

English