

5223957-1 ✓ ACTIVE

Z-PACK 2mm HM

TE Internal #: 5223957-1

Backplane Guide Hardware, Guide Socket Module, Z-PACK 2mm HM

[View on TE.com >](#)



Connectors > PCB Connectors > Backplane Connectors > Backplane Guide Hardware

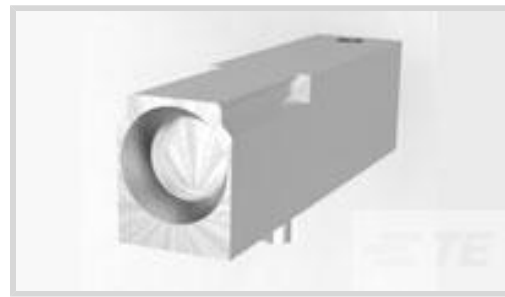

Connector Guide Hardware Type: **Guide Socket Module**

Features

Product Type Features

Connector Guide Hardware Type	Guide Socket Module
-------------------------------	---------------------

Configuration Features

PCB Mount Orientation	Right Angle
-----------------------	-------------

Body Features

Guide Component Plating Material Finish Process	Chromate Conversion Coating
Guide Component Base Material	Zinc Alloy Die Casting

Termination Features

Compatible With Backplane Interface Type	2mm HM
--	--------

Dimensions

Product Length	34.2 mm
----------------	---------

Packaging Features

Packaging Quantity	1
Packaging Method	Box

Product Compliance

[For compliance documentation, visit the product page on TE.com>](#)

EU RoHS Directive 2011/65/EU	Compliant
EU ELV Directive 2000/53/EC	Compliant
China RoHS 2 Directive MIIT Order No 32, 2016	No Restricted Materials Above Threshold
EU REACH Regulation (EC) No. 1907/2006	Current ECHA Candidate List: JUNE 2023 (235)



Candidate List Declared Against: JUNE 2023 (235)

Does not contain REACH SVHC

Halogen Content	Low Halogen - Br, Cl, F, I < 900 ppm per homogenous material. Also BFR/CFR/PVC Free
Solder Process Capability	Not applicable for solder process capability

Product Compliance Disclaimer

This information is provided based on reasonable inquiry of our suppliers and represents our current actual knowledge based on the information they provided. This information is subject to change. The part numbers that TE has identified as EU RoHS compliant have a maximum concentration of 0.1% by weight in homogenous materials for lead, hexavalent chromium, mercury, PBB, PBDE, DBP, BBP, DEHP, DIBP, and 0.01% for cadmium, or qualify for an exemption to these limits as defined in the Annexes of Directive 2011/65/EU (RoHS2). Finished electrical and electronic equipment products will be CE marked as required by Directive 2011/65/EU. Components may not be CE marked. Additionally, the part numbers that TE has identified as EU ELV compliant have a maximum concentration of 0.1% by weight in homogenous materials for lead, hexavalent chromium, and mercury, and 0.01% for cadmium, or qualify for an exemption to these limits as defined in the Annexes of Directive 2000/53/EC (ELV). Regarding the REACH Regulation, the information TE provides on SVHC in articles for this part number is based on the latest European Chemicals Agency (ECHA) 'Guidance on requirements for substances in articles' posted at this URL: <https://echa.europa.eu/guidance-documents/guidance-on-reach>

Compatible Parts



Also in the Series | Z-PACK 2mm HM

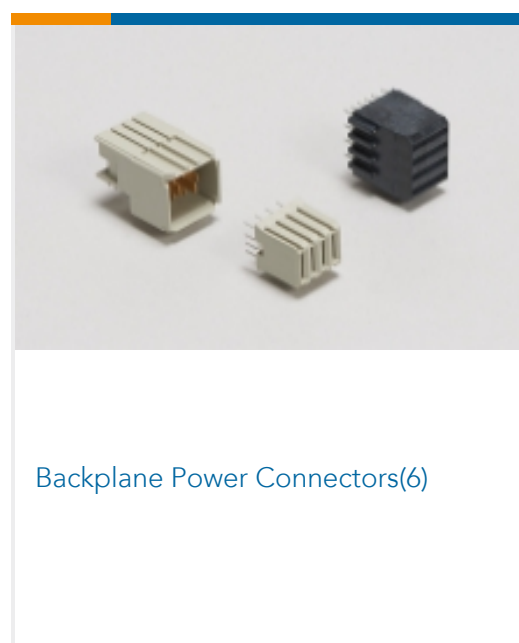
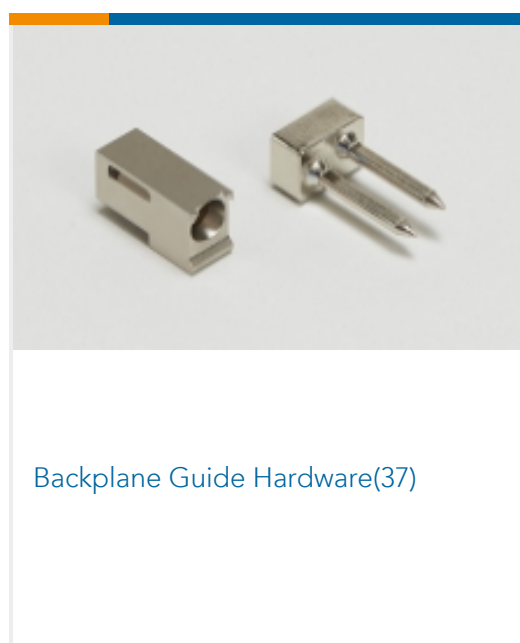
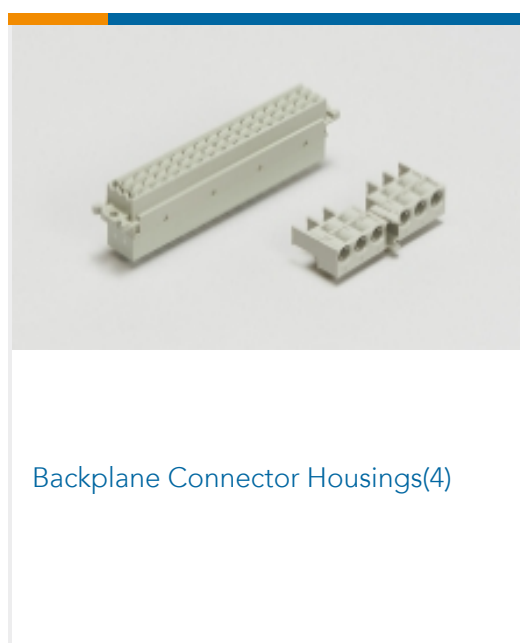
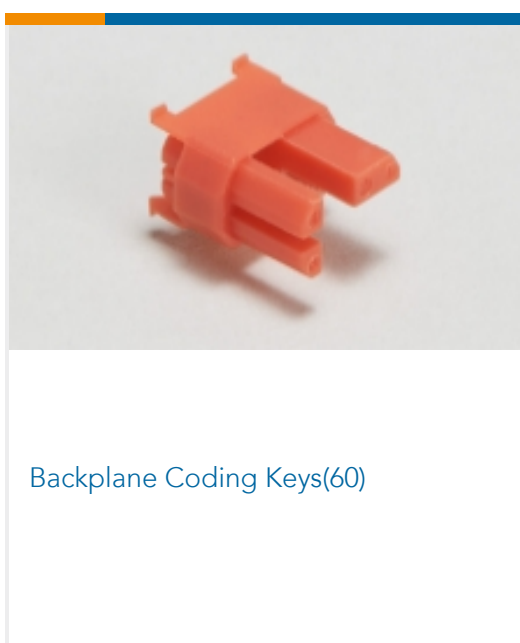



Board-to-Board Connector Contacts(2)

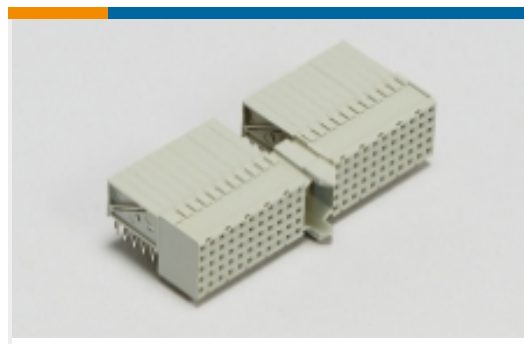

Hard Metric Backplane Connectors (269)

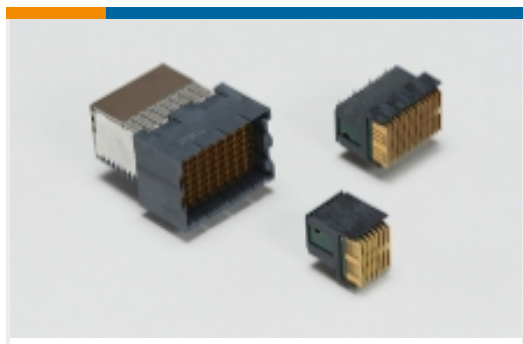

High Speed Backplane Connectors(1)



Insertion & Extraction Tools(2)



PCB Connector Covers(4)



PCB Connector Shrouds(39)



PCB Ferrules & Shields(19)



Rectangular Power Connectors(87)

Customers Also Bought



TE Part #223969-7
UNV PWR MDL, GUIDE PIN LOCT PL

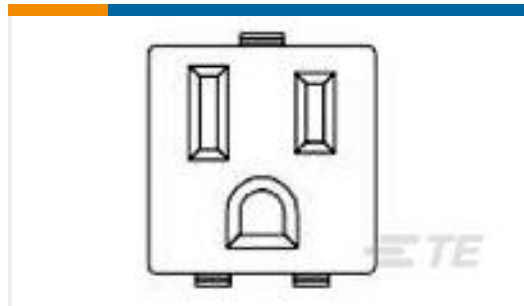

TE Part #3-213598-2
CNV OUTLET PCBOARD MNT, BLK LF

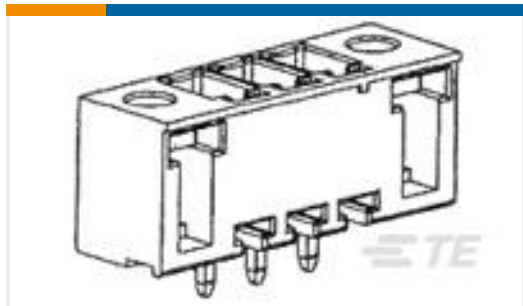

TE Part #796867-2
2 POS TERMI-BLOK HDR VERTICAL

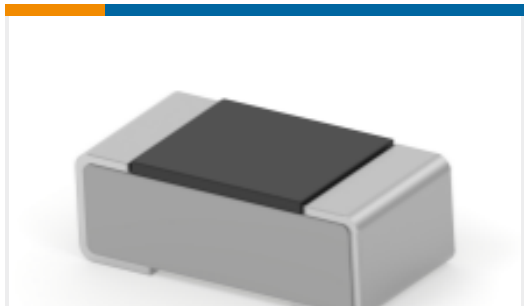

TE Part #1-2176338-4
CRGCO 0402 150R 5%



TE Part #1-2176328-8
CRGP 1206 270R 1%

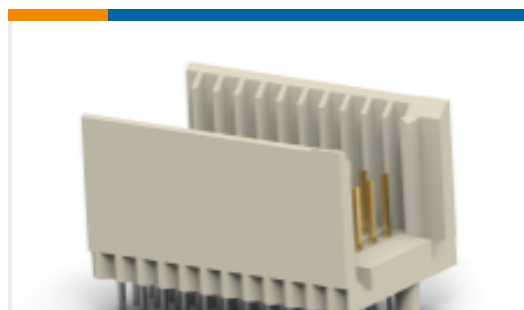

TE Part #3-100141-0
Hard Metric Male Connector:
Traditional Backplane, Mezzanine,
2mm



TE Part #1544191-2
CTS 1,905 BRONZE E

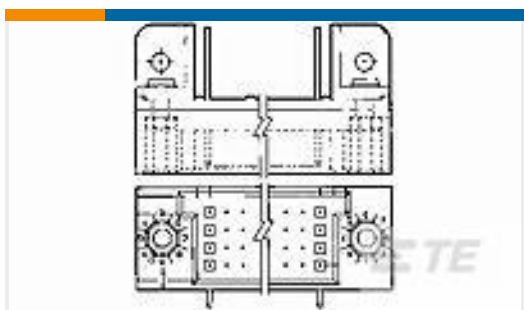

TE Part #533286-1
HDI PIN ASSY 4 ROW 100 POS R/A



TE Part #3-2176375-5
RQ 0805 2K61 0.1% 10PPM 1K RL

Documents



Product Drawings

UPM GUIDE MODULE

English

CAD Files

Customer View Model

[ENG_CVM_CVM_5223957-1_A.2d_dxf.zip](#)

English

3D PDF

3D

Customer View Model

[ENG_CVM_CVM_5223957-1_A.3d_igs.zip](#)

English

Customer View Model

[ENG_CVM_CVM_5223957-1_A.3d_stp.zip](#)

English

By downloading the CAD file I accept and agree to the [Terms and Conditions](#) of use.

Datasheets & Catalog Pages

POWER_CONNECTORS_CATALOG_SEC01_BOARD_TO_BOARD

English

[2_PIECE_POWER_CONNECTORS_qrg_4-1773458-1](#)

English

Product Specifications

Engineering Report

English

Product Environmental Compliance

[MD_5223957-1_062520182350_dmtec](#)

English

[MD_5223957-1_062520182350_dmtec](#)

English