

5223513-2 ✓ ACTIVE

Z-PACK | Z-PACK Future Bus+

TE Internal #: 5223513-2

Backplane Connector Housings, Board-to-Board, 48 Position, 4 Row, 12 Column, Housing for Male Terminals, Sealable, Z-PACK Future Bus+

[View on TE.com >](#)



Connectors > PCB Connectors > Backplane Connectors > Backplane Connector Housings

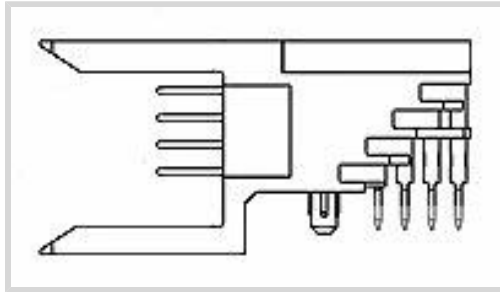

Connector System: **Board-to-Board**

Number of Positions: **48**

Centerline (Pitch): **2 mm**

Row-to-Row Spacing: **2 mm**

Number of Rows: **4**

Features

Product Type Features

Connector System	Board-to-Board
Connector & Housing Type	Housing for Male Terminals
Sealable	Yes
Connector & Contact Terminates To	Printed Circuit Board

Configuration Features

Number of Positions	48
Number of Rows	4
Number of Columns	12

Contact Features

Contact Current Rating (Max)	1 A
------------------------------	-----

Mechanical Attachment

Connector Mounting Type	Board Mount
-------------------------	-------------

Housing Features

Centerline (Pitch)	2 mm
--------------------	------

Dimensions

Row-to-Row Spacing	2 mm
--------------------	------

Usage Conditions

--	--

Operating Temperature Range	-55 – 125 °C
-----------------------------	--------------

Operation/Application

Circuit Application	Signal
---------------------	--------

Product Compliance



[For compliance documentation, visit the product page on TE.com>](#)

EU RoHS Directive 2011/65/EU	Compliant
EU ELV Directive 2000/53/EC	Compliant
China RoHS 2 Directive MIIT Order No 32, 2016	No Restricted Materials Above Threshold
EU REACH Regulation (EC) No. 1907/2006	Current ECHA Candidate List: JUNE 2023 (235) Candidate List Declared Against: JUNE 2023 (235) Does not contain REACH SVHC
Halogen Content	Low Halogen - Br, Cl, F, I < 900 ppm per homogenous material. Also BFR/CFR/PVC Free
Solder Process Capability	Pin-in-Paste capable to 260°C

Product Compliance Disclaimer

This information is provided based on reasonable inquiry of our suppliers and represents our current actual knowledge based on the information they provided. This information is subject to change. The part numbers that TE has identified as EU RoHS compliant have a maximum concentration of 0.1% by weight in homogenous materials for lead, hexavalent chromium, mercury, PBB, PBDE, DBP, BBP, DEHP, DIBP, and 0.01% for cadmium, or qualify for an exemption to these limits as defined in the Annexes of Directive 2011/65/EU (RoHS2). Finished electrical and electronic equipment products will be CE marked as required by Directive 2011/65/EU. Components may not be CE marked. Additionally, the part numbers that TE has identified as EU ELV compliant have a maximum concentration of 0.1% by weight in homogenous materials for lead, hexavalent chromium, and mercury, and 0.01% for cadmium, or qualify for an exemption to these limits as defined in the Annexes of Directive 2000/53/EC (ELV). Regarding the REACH Regulation, the information TE provides on SVHC in articles for this part number is based on the latest European Chemicals Agency (ECHA) 'Guidance on requirements for substances in articles' posted at this URL: <https://echa.europa.eu/guidance-documents/guidance-on-reach>

Compatible Parts

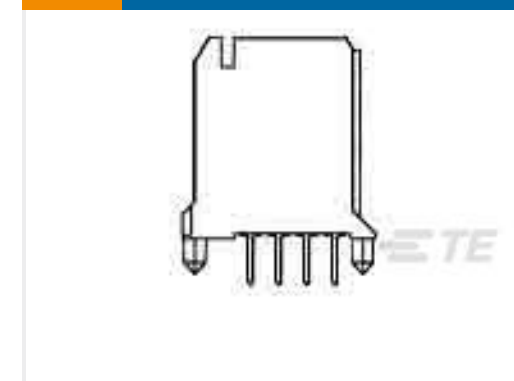
 <p>TE Part # 5536507-2 2MM FB,ASY,048,SIG,REC,SL,2.73</p>	 <p>TE Part # 5536511-2 2MM FB,ASY,048,SIG,REC,EN,3.55</p>	 <p>TE Part # 5536510-2 2MM FB,ASY,048,SIG,REC,SL,3.53</p>	 <p>TE Part # 5223650-2 2MM FB,4RV,REC,ASY,048,PF,4.25</p>
---	--	---	---

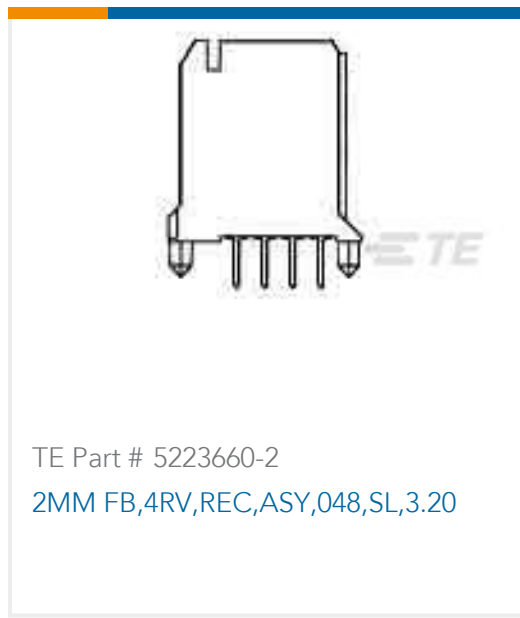
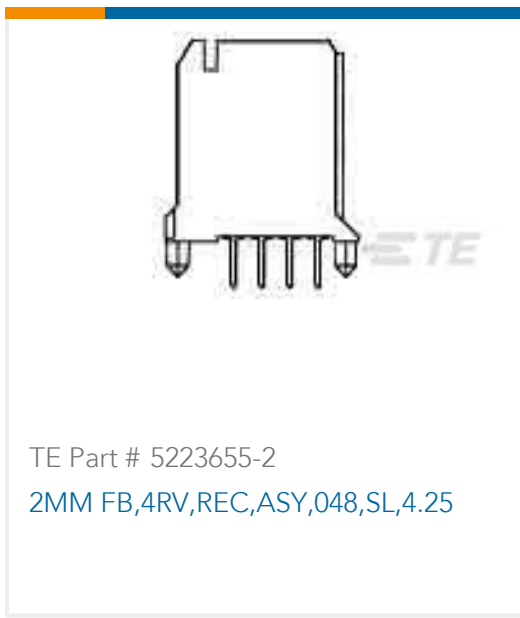

Also in the Series | Z-PACK Future Bus+

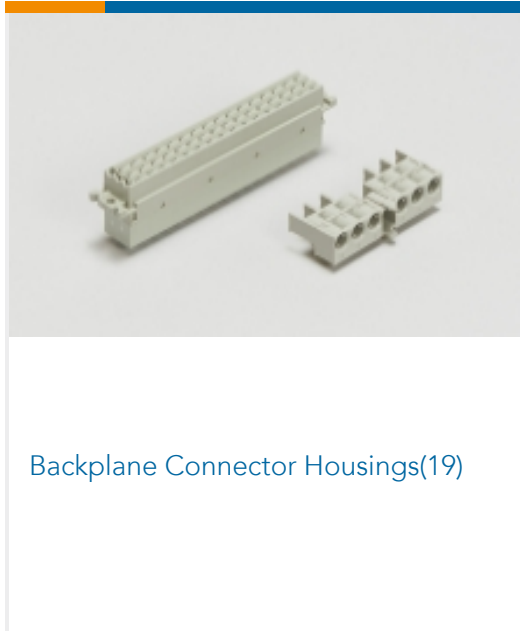

Customers Also Bought

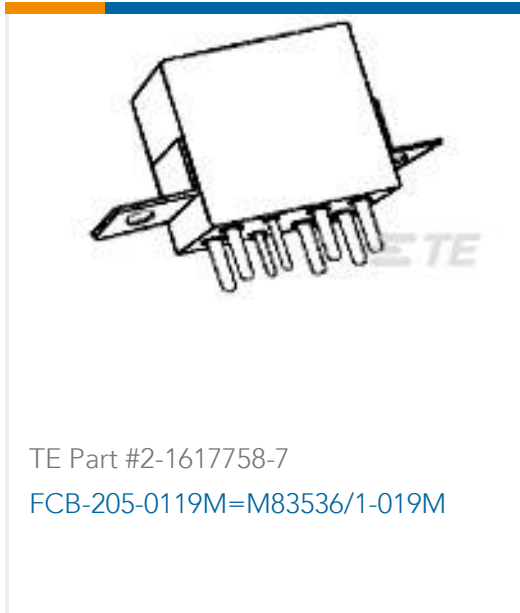



Documents

CAD Files

3D PDF

3D

Customer View Model

[ENG_CVM_CVM_5223513-2_O.2d_dxf.zip](#)

English

Customer View Model

[ENG_CVM_CVM_5223513-2_O.3d_igs.zip](#)

English

Customer View Model

[ENG_CVM_CVM_5223513-2_O.3d_stp.zip](#)

English

By downloading the CAD file I accept and agree to the [Terms and Conditions](#) of use.

Product Specifications

Application Specification

English

Product Environmental Compliance

[MD_5223513-2_030720171129_dmtec](#)

English

[MD_5223513-2_030720171129_dmtec](#)

English

Agency Approvals

UL Report

English