

521209-1 ✓ ACTIVE

RAST | RAST 5 IDC Connectors

TE Internal #: 521209-1

Housing, Receptacle, Wire-to-Wire, 7 Position, .197 in [5 mm]

Centerline, Crimp, 1 Row, Blue, Mating Retention, Wire & Cable,

RAST 5 IDC Connectors

[View on TE.com >](#)



Connectors > PCB Connectors > Wire-to-Board Connectors > Wire-to-Board Connector Assemblies & Housings

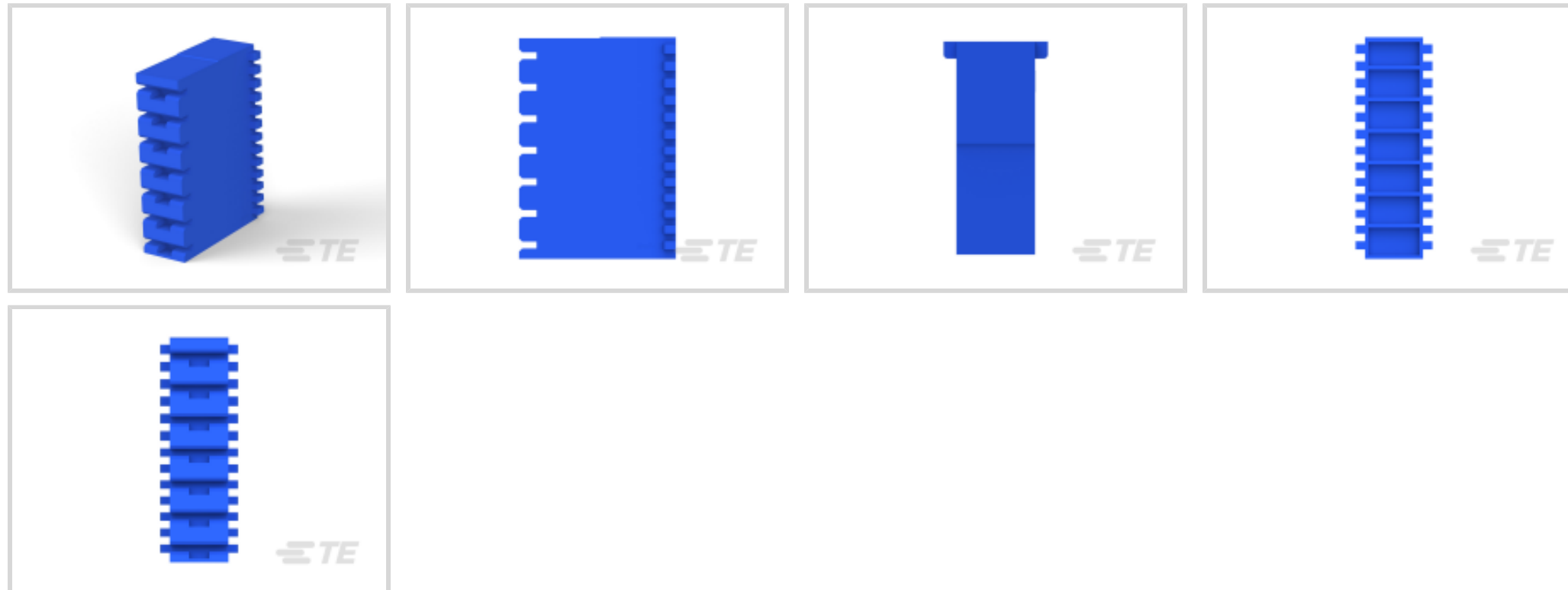

Connector Product Type: **Housing**

Connector & Housing Type: **Receptacle**

Connector System: **Wire-to-Wire**

Number of Positions: 7

Centerline (Pitch): 5 mm [.197 in]

Features

Product Type Features

Connector Product Type	Housing
Connector & Housing Type	Receptacle
Connector System	Wire-to-Wire
Sealable	No
Connector & Contact Terminates To	Wire & Cable

Configuration Features

Number of Positions	7
Number of Rows	1

Body Features

Primary Product Color	Blue
-----------------------	------

Contact Features

Contact Layout	Inline
Contact Type	Socket
Contact Base Material	Brass



Termination Features

Termination Method to Wire & Cable	Crimp
------------------------------------	-------

Mechanical Attachment

Strain Relief	Without
Panel Mount Feature	Without
PCB Mount Retention	Without
Mating Retention Type	Latch
Mating Retention	With
Connector Mounting Type	Cable Mount (Free-Hanging)

Housing Features

Housing Entry Configuration	Both Ends Closed
Housing Material	Nylon 66/6
Centerline (Pitch)	5 mm [.197 in]

Dimensions

Connector Length	9.2 mm [.362 in]
Connector Height	12.2 mm [.48 in]
Row-to-Row Spacing	5 mm [.197 in]

Usage Conditions

Operating Temperature Range	-40 – 110 °C [-40 – 230 °F]
-----------------------------	-----------------------------

Operation/Application

Circuit Application	Power & Signal
---------------------	----------------

Industry Standards

Glow Wire Rating	Standard Part - Not Glow Wire
UL Flammability Rating	UL 94V-0

Packaging Features

Packaging Quantity	1
Packaging Method	Package

Product Compliance

[For compliance documentation, visit the product page on TE.com>](#)

EU RoHS Directive 2011/65/EU	Compliant
------------------------------	-----------



EU ELV Directive 2000/53/EC	Compliant
China RoHS 2 Directive MIIT Order No 32, 2016	No Restricted Materials Above Threshold
EU REACH Regulation (EC) No. 1907/2006	Current ECHA Candidate List: JUNE 2023 (235) Candidate List Declared Against: JUNE 2023 (235) Does not contain REACH SVHC
Halogen Content	Low Halogen - Br, Cl, F, I < 900 ppm per homogenous material. Also BFR/CFR/PVC Free
Solder Process Capability	Not applicable for solder process capability

Product Compliance Disclaimer

This information is provided based on reasonable inquiry of our suppliers and represents our current actual knowledge based on the information they provided. This information is subject to change. The part numbers that TE has identified as EU RoHS compliant have a maximum concentration of 0.1% by weight in homogenous materials for lead, hexavalent chromium, mercury, PBB, PBDE, DBP, BBP, DEHP, DIBP, and 0.01% for cadmium, or qualify for an exemption to these limits as defined in the Annexes of Directive 2011/65/EU (RoHS2). Finished electrical and electronic equipment products will be CE marked as required by Directive 2011/65/EU. Components may not be CE marked. Additionally, the part numbers that TE has identified as EU ELV compliant have a maximum concentration of 0.1% by weight in homogenous materials for lead, hexavalent chromium, and mercury, and 0.01% for cadmium, or qualify for an exemption to these limits as defined in the Annexes of Directive 2000/53/EC (ELV). Regarding the REACH Regulation, the information TE provides on SVHC in articles for this part number is based on the latest European Chemicals Agency (ECHA) 'Guidance on requirements for substances in articles' posted at this URL: <https://echa.europa.eu/guidance-documents/guidance-on-reach>

Compatible Parts

 <p>TE Part # 521208-1 POSI-LOK HSG.250-6 POS RAST5</p>	 <p>TE Part # 521206-1 POSI-LOK HSG.250-4 POS RAST5</p>	 <p>TE Part # 521207-1 POSI-LOK HSG.250-5 POS RAST5</p>	 <p>TE Part # 521207-4 HSG,RAST 5,POSI LOCK MKIII,5P</p>
 <p>TE Part # 521207-3 HSG POSI-LOCK MARK III</p>	 <p>TE Part # 521206-3 HSG,4P,POS LOCK,MKIII,250 SERI</p>	 <p>TE Part # 521206-6 POSI-LOK HSG.250-4 POS RAST5</p>	 <p>TE Part # 521208-4 HSG,250 POSI-LOCK,MKIII,6 POS,</p>



TE Part # 521208-5
HSG,250 POSI-LOC,MKII,6P,NAT



TE Part # 521209-2
HSG POSI-LOCK MARK III



TE Part # 521206-2
250 SERIES 4 POS POSILOK HSG



TE Part # 521206-4
HSG,POSI-LOCK MKIII RAST,4P



TE Part # 521206-5
HSG,RECP,POSI-LOCK MKIII,4P



TE Part # 521207-2
POSI-LOK HSG 250 5P RAST5



TE Part # 521207-5
HSG POSI-LOK 250 (05-B) RAST



TE Part # 521208-2
HOUSING POSITIVE LOCK RAST



TE Part # 521208-6
HSG,POSI-LOCK MKIII RAST,6P



TE Part # 521835-4
HSG,RAST 5 PL,7P,BLOCK 3,5

Also in the Series | RAST 5 IDC Connectors

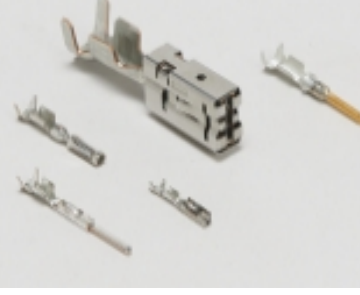

Automotive Terminals(8)



Connector Contacts(12)



Crimp Terminal Housings(41)



Insertion & Extraction Tools(1)



PCB Headers & Receptacles(417)



Rectangular Connector Housings(1)

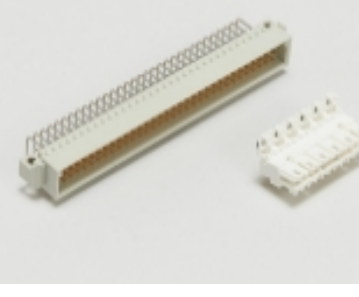

Standard Edge Connectors(34)

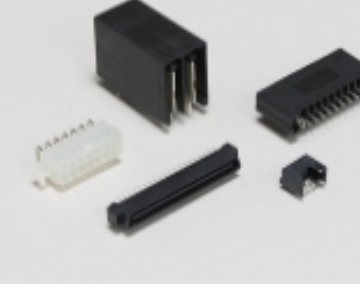

Standard Rectangular Connectors(68)



Wire-to-Board Connector Assemblies & Housings(214)



Wire-to-Board Connector Contacts(2)

Customers Also Bought

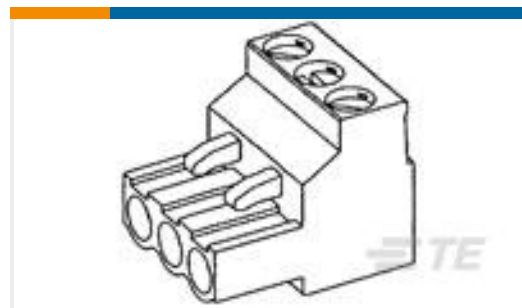
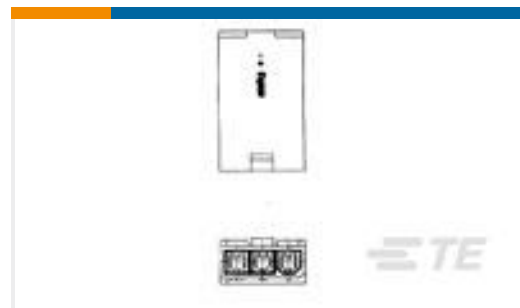
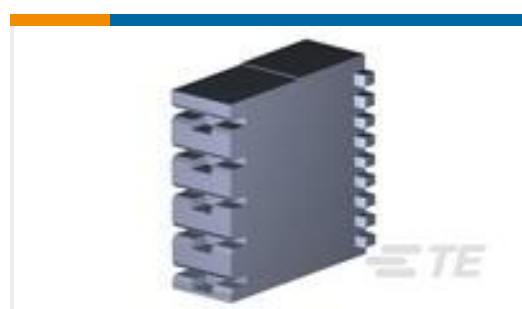
TE Part #796640-4
4 POS 5.0 MM R/A PLUG,TRM BLKTE Part #1586105-3
3P RCPT VAL-U-LOK SR V2TE Part #61944-1
250 FASTON REC 18-14 AWG BRTE Part #42742-1
250 FASTON FLAG REC 18-12 AWG BRTE Part #1217094-1
RCPT 250 POS-LOCK 18-14 0126BRTE Part #794203-1
14P MINI UMNL2 CAP HSG UL94V0TE Part #794228-1
MINI UMNL2 PIN 22-18 AWG SN LPTE Part #794229-1
MINI UMNL2 SOK 22-18 AWG SN LPTE Part #521207-1
POSI-LOK HSG.250-5 POS RAST5TE Part #794245-1
08P MINI UMNL2 PLUG HSG UL94V2

Documents

Product Drawings

[POSI-LOK HSG.250-7 POS RAST5](#)

English

CAD Files

[3D PDF](#)

3D

[Customer View Model](#)

[ENG_CVM_CVM_521209-1_N.2d_dxf.zip](#)



English

Customer View Model

[ENG_CVM_CVM_521209-1_N.3d_igs.zip](#)

English

Customer View Model

[ENG_CVM_CVM_521209-1_N.3d_stp.zip](#)

English

By downloading the CAD file I accept and agree to the [Terms and Conditions](#) of use.

Datasheets & Catalog Pages

[1654742_HOUSEHOLD_APPLIANCES_RAST5](#)

English