

521125-1 ✓ ACTIVE

Positive Lock | Mark II, Positive Lock 187

TE Internal #: 521125-1

Crimp Terminal Housings, Tab, Tab Housing, 1 Position, Straight,
UL 94V-0, Natural, Nylon, Contact Mating Retention, Positive Lock
187

[View on TE.com >](#)



Terminals & Splices > Terminal Housings, Insulation Sleeves & Blocks > Crimp Terminal Housings



Terminal Type: **Tab**

Connector & Housing Type: **Tab Housing**

Number of Positions: **1**

Terminal Orientation: **Straight**

UL Flammability Rating: **UL 94V-0**

Features

Product Type Features

Sealable	No
Connector & Contact Terminates To	Wire & Cable
Connector & Housing Type	Tab Housing

Configuration Features

Number of Positions	1
---------------------	---

Body Features

Primary Product Color	Natural
-----------------------	---------

Contact Features

Terminal Type	Tab
Terminal Orientation	Straight
Contact Mating Retention	With

Mechanical Attachment

Mating Alignment Type	Polarization
-----------------------	--------------



Mating Alignment	With
Connector Mounting Type	Cable Mount (Free-Hanging)

Housing Features

Housing Material	Nylon
------------------	-------

Dimensions

Product Length	24.75 mm[.974 in]
----------------	-------------------

Usage Conditions

Operating Temperature Range	-40 – 105 °C[-40 – 221 °F]
-----------------------------	----------------------------

Industry Standards

UL Flammability Rating	UL 94V-0
------------------------	----------

Packaging Features

Packaging Quantity	1
Packaging Method	Carton

Other

Crimp Terminal Housing Comment	Accepts .187 Series positive lock connector.
--------------------------------	--

Product Compliance

[For compliance documentation, visit the product page on TE.com>](#)

EU RoHS Directive 2011/65/EU	Compliant
EU ELV Directive 2000/53/EC	Compliant
China RoHS 2 Directive MIIT Order No 32, 2016	No Restricted Materials Above Threshold
EU REACH Regulation (EC) No. 1907/2006	Current ECHA Candidate List: JUNE 2023 (235) Candidate List Declared Against: JUNE 2023 (235) Does not contain REACH SVHC
Halogen Content	Low Halogen - Br, Cl, F, I < 900 ppm per homogenous material. Also BFR/CFR/PVC Free
Solder Process Capability	Not applicable for solder process capability

Product Compliance Disclaimer

This information is provided based on reasonable inquiry of our suppliers and represents our current actual knowledge based on the information they provided. This information is subject to change. The part numbers that TE has identified as EU RoHS compliant have a maximum concentration of 0.1% by weight in homogenous materials for lead, hexavalent chromium, mercury, PBB, PBDE, DBP, BBP, DEHP, DIBP, and 0.01% for cadmium, or qualify for an exemption to these limits as defined in the Annexes of Directive 2011/65/EU (RoHS2). Finished electrical and electronic equipment products

will be CE marked as required by Directive 2011/65/EU. Components may not be CE marked. Additionally, the part numbers that TE has identified as EU ELV compliant have a maximum concentration of 0.1% by weight in homogenous materials for lead, hexavalent chromium, and mercury, and 0.01% for cadmium, or qualify for an exemption to these limits as defined in the Annexes of Directive 2000/53/EC (ELV). Regarding the REACH Regulation, the information TE provides on SVHC in articles for this part number is based on the latest European Chemicals Agency (ECHA) 'Guidance on requirements for substances in articles' posted at this URL: <https://echa.europa.eu/guidance-documents/guidance-on-reach>

Compatible Parts



TE Part # 170326-1
187 PL MKII REC. 18-14AWG PTBR



TE Part # 170324-1
187 PL MKII REC. 24-20AWG PTBR



TE Part # 170325-1
187 PL MKII REC. 20-16AWG PTBR



TE Part # 1-176448-1
187 POSITIVE LOCK MK-II TAB HSG 1POS

Also in the Series | Mark II



Automotive Housings(8)

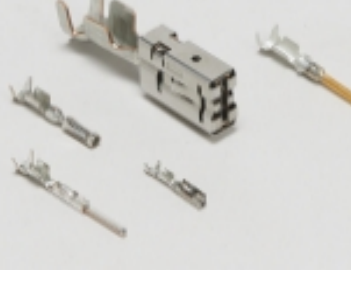

Automotive Terminals(22)

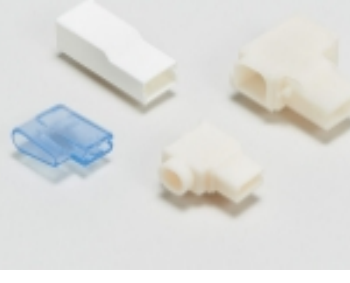

Crimp Terminal Housings(76)



Insertion & Extraction Tools(2)



Quick Disconnects(57)

Also in the Series | Positive Lock 187



Crimp Terminal Housings(86)



Insertion & Extraction Tools(2)



Insulation Boots & Sleeves(7)



Quick Disconnects(57)

Customers Also Bought

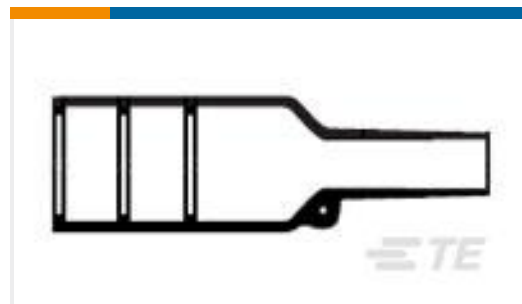
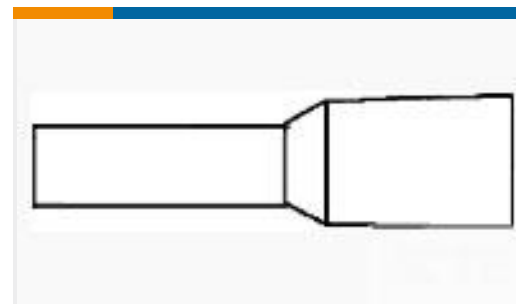
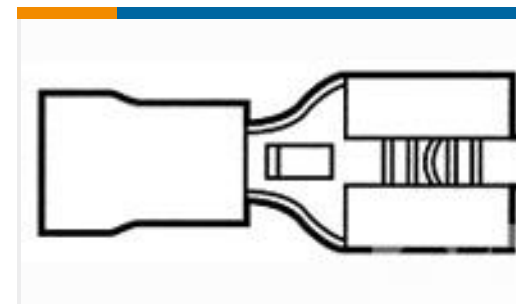
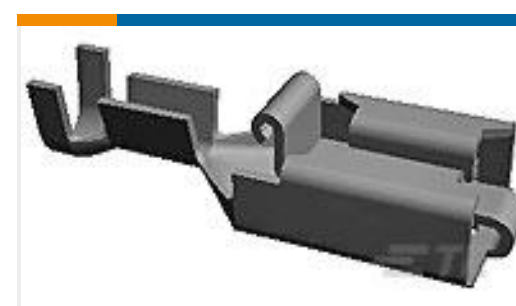
TE Part #864607-000
202K142-25/225-0TE Part #T4113002081-000
M12,MALE,RA,A CODE,8P,PG9,GOLDTE Part #1-966067-2
FER,WIRE,PL SLV,1.50/16,L8,BLACK,LPTE Part #9-160583-5
250 PIDG FASTON RECTE Part #1-154719-0
PL 250 REC HSG 1P NYLON NATTE Part #1734098-4
Champ050 40p A/P RCPT 25CL PBTE Part #5-747916-2
37 Plug Solder Cup, Gold FlashTE Part #160831-3
250 PL MKI REC. 17-13AWG TPBRTE Part #282349-1
PL 250 FLAG REC 0.5-1.5MM2 0.4 X 44
NISI

Documents

Product Drawings

[PL 187 HOUSING TAB 0.81 NYLON 6/6](#)

English

CAD Files

[3D PDF](#)

3D

Customer View Model

[ENG_CVM_CVM_521125-1_D_c-521125-1-d.2d_dxf.zip](#)



English

Customer View Model

[ENG_CVM_CVM_521125-1_D_c-521125-1-d.3d_igs.zip](#)

English

Customer View Model

[ENG_CVM_CVM_521125-1_D_c-521125-1-d.3d_stp.zip](#)

English

By downloading the CAD file I accept and agree to the [Terms and Conditions](#) of use.

Datasheets & Catalog Pages

Positive Lock Receptacles

English

[POS_LOCK_MII_QRG](#)

English

Product Environmental Compliance

[MD_521125-1_120720171118_dmtec](#)

English

[MD_521125-1_120720171118_dmtec](#)

English

Agency Approvals

CSA Certificate

English

CSA Certificate

English